

\$1.50

ham radio

magazine

hr 

JUNE 1978

- Oscar 8 preamplifier 20
- *Touch-Tone* decoder 26
- vfo design 36
- pi network design 52
- voltmeter calibrator 94
- and much more . . .

RTTY SELCOM



HALF A CENTURY OF SERVICE

Fifty years ago in 1928, Henry Radio first offered to help amateur radio operators solve their communications problems. Today Amateurs, not only in the United States but throughout the free world, still look to Henry Radio as their pre-eminent supplier of fine communications equipment. Fifty years is a long time in the life of an individual. It is a long time in the history of amateur radio. So we are proud to be celebrating our fiftieth anniversary of service to Amateur Radio. We believe it says something important about Henry Radio and about the pioneering contributions we have made to our industry.

From the beginning, we offered personalized service. Service that recognized that every person's needs were as individual as each person is unique.

We were the first to offer low cost time sales of Amateur equipment. We were among the first to trade for used equipment.

Even then we had an expert service department to assure that each

piece of equipment operated the way it should. We pioneered "satisfaction guaranteed" and the ten day free trial policy. Then as now we recognized our obligation to provide amateurs everywhere with fine equipment and good service.

At Henry Radio we don't know any other way of doing business. Since we have been active amateurs for all these years, we know the correct answers when we ask ourselves, "Is this the way I would want to be served if I were a customer of Henry Radio?"

Looking back, 50 years seems a long time. Looking ahead we feel like eager youngsters impatient to know the exciting new experiences that the next 50 years will bring. Eager to help our amateur friends all over the world share the unique communication thrills that only amateur radio can provide.

May we help you?



Mary & Selva
W6VWL

Ted Henry

Bob Henry
W0ARA

Meredith Henry
W6WNE

Ted S Henry
W6YEY

Walt Henry
W6ZN

11240 W. Olympic Blvd., Los Angeles, Calif. 90064 213/477-6701
931 N. Euclid, Anaheim, Calif. 92801 714/772-9200
Butler, Missouri 64730 816/679-3127

Henry Radio

THE NEW INDUSTRY STANDARD OF PERFORMANCE... IS THE **Wilson SYSTEM ONE!**

A DX'er's delight operating 20 meters on a full 26' boom with 4 elements, 4 operational elements on 20-15-10, plus separate reflector element on 10 meters for correct monoband spacing. Featured are the large diameter High-Q traps, Beta matching system, heavy duty taper swaged elements, rugged boom to element mounting... **and value priced!** Additional features: • SWR less than 1.5 to 1 on all bands • 10 dB Gain • 20-25 dB Front-to-Back Ratio.

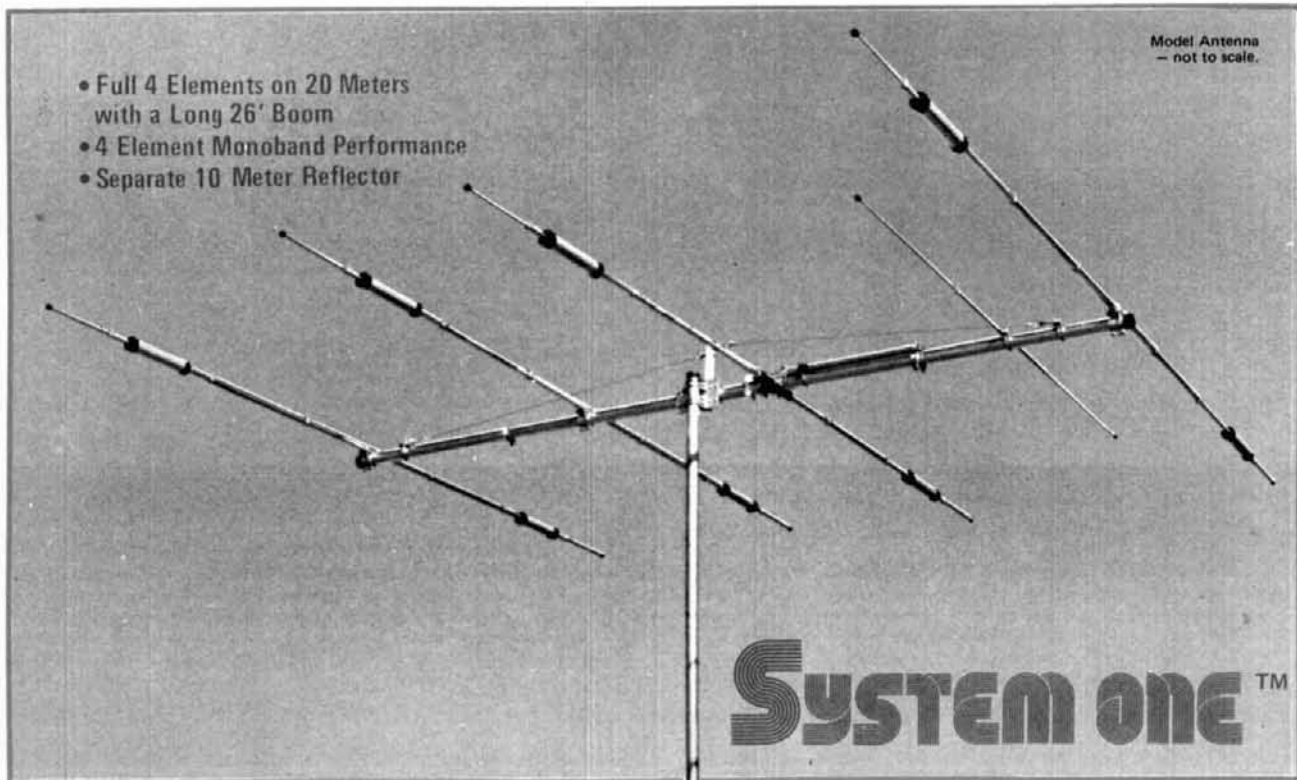

- Full 4 Elements on 20 Meters with a Long 26' Boom
- 4 Element Monoband Performance
- Separate 10 Meter Reflector

SYSTEM ONE™

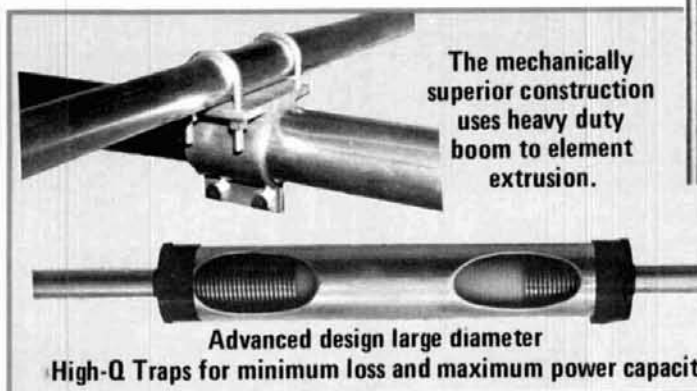

The mechanically superior construction uses heavy duty boom to element extrusion.

Advanced design large diameter High-Q Traps for minimum loss and maximum power capacity

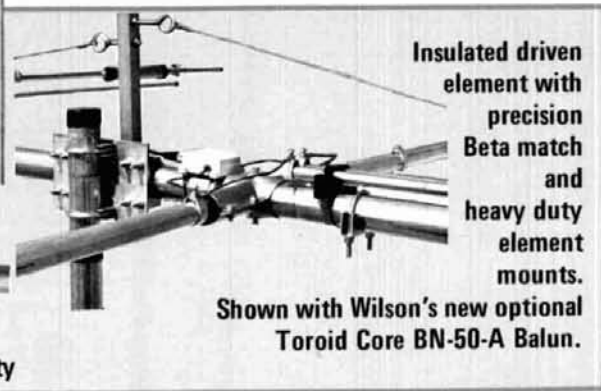

Insulated driven element with precision Beta match and heavy duty element mounts.

Shown with Wilson's new optional Toroid Core BN-50-A Balun.

SPECIFICATIONS: SY-1

Matching Method Beta	Boom Length 26'	Required Mast Diameter 2" O.D.
Band MHz 14-21-28	Boom Diameter 2" O.D.	Surface Area 8.6 sq. ft.
Maximum Power Input Legal Limit	No. of Elements 5	Windload at 78 mph 215 lbs.
VSWR (at Resonance) 1.5 to 1	Longest Element 26' 7"	Shipping Weight 65 lbs.
Impedance 50 ohms	Turning Radius 18' 6"	UPS Shipment in 2 Cartons
Gain 10 dB	F/B Ratio 20-25 dB	

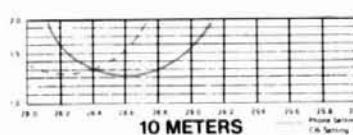
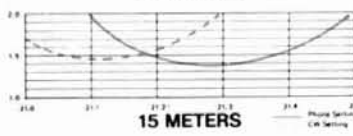
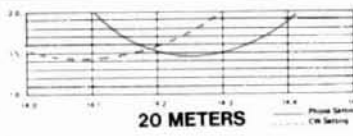

DEALERSHIPS AVAILABLE!!!
We are looking for new Dealers for certain areas of the country. If you are interested, contact us for details.

Wilson Electronics Corp.

4288 So. Polaris • P. O. Box 19000 • Las Vegas, Nevada 89119
Phone (702) 739-1931 • Telex 684-522

This NEW MFJ Versa Tuner II . . .

has SWR and dual range wattmeter, antenna switch, efficient airwound inductor, built in balun. Up to 300 watts RF output. Matches everything from 160 thru 10 Meters: dipoles, inverted vees, random wires, verticals, mobile whips, beams, balance lines, coax lines.



BRAND NEW
\$79⁹⁵

Antenna matching capacitor. 208 pf. 1000 volt spacing.

Sets power range, 300 and 30 watts. Pull for SWR.

Meter reads SWR and RF watts in 2 ranges.

Efficient airwound inductor gives more watts out and less losses.

Transmitter matching capacitor. 208 pf. 1000 volt spacing.

Only MFJ gives you this MFJ-941 Versa Tuner II with all these features at this price:

A SWR and dual range wattmeter (300 and 30 watts full scale) lets you measure RF power output for simplified tuning.

An antenna switch lets you select 2 coax fed antennas, random wire or balance line, and tuner bypass.

A new efficient airwound inductor (12 positions) gives you less losses than a tapped toroid for more watts out.

A 1:4 balun for balance lines. 1000 volt capacitor spacing. Mounting brackets for mobile installations (not shown).

With the NEW MFJ Versa Tuner II you can run your full transceiver power output — up to 300 watts RF power output — and match your

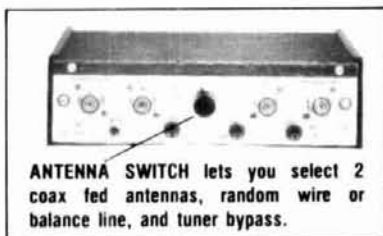

ANTENNA SWITCH lets you select 2 coax fed antennas, random wire or balance line, and tuner bypass.

transmitter to any feedline from 160 thru 10 Meters whether you have coax cable, balance line, or random wire.

You can tune out the SWR on your dipole, inverted vee, random wire, vertical, mobile whip, beam, quad, or whatever you have.

You can even operate all bands with just

one existing antenna. No need to put up separate antennas for each band.

Increase the usable bandwidth of your mobile whip by tuning out the SWR from inside your car. Works great with all solid state rigs (like the Atlas) and with all tube type rigs.

It travels well, too. Its ultra compact size 8x2x6 inches fit easily in a small corner of your suitcase.

This beautiful little tuner is housed in a deluxe eggshell white Ten-Tec enclosure with walnut grain sides.

S0-239 coax connectors are provided for transmitter input and coax fed antennas. Quality five way binding posts are used for the balance line inputs (2), random wire input (1), and ground (1).

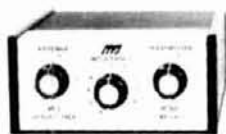

\$59⁹⁵

BRAND NEW

MFJ-901 VERSA TUNER

New efficient air wound coil for more watts out.

Only MFJ uses an efficient air wound inductor (12 positions) in this class of tuners to give you more watts out and less losses than a tapped toroid. Matches everything from 160 thru 10 Meters: dipoles, inverted vees, random wires, verticals, mobile whips, beams, balance lines, coax lines. Up to 200 watts RF output 1:4 balun for balance lines. Tune out the SWR of your mobile whip from inside your car. Works with all rigs. Ultra compact 5x2x6 inches. S0 239 connectors. 5 way binding posts. Ten Tec enclosure.



\$49⁹⁵

BRAND NEW

MFJ-900 ECONO TUNER

Same as MFJ-901 Versa Tuner, but does not have built-in balun for balance lines. Tunes coax lines and random lines.



\$39⁹⁵

MFJ-16010 RANDOM WIRE TUNER

Operate 160 thru 10 Meters. Up to 200 watts RF output. Matches high and low impedances. 12 position inductor. S0-239 connectors. 2x3x4 inches. Matches 25 to 200 ohms at 1.8 MHz.



\$39⁹⁵

BRAND NEW

MFJ-400 8043 ECONO KEYS

MFJ brings you a reliable, full feature economy keyer using the famous CURTIS-8043 keyer-on-a-chip.

Panel Controls: Speed (8 to 50 WPM), pull-to-tune; volume, on/off; 3 conductor, 1/4 inch phone jack for keying output and key paddle input.

Internal weight control lets you adjust dot-dash-space ratio for a distinctive signal to penetrate ORM for solid DX contacts. Sidetone and speaker. Internal tone control.

Lambic operation with squeeze key. Dot memory. Instant start. Self completing. Jamproof spacing. Reliable solid state keying: gnd block, cathode, solid state transmitters (-300V, 10 ma. max. and +300V, 100 ma. max.).

For Orders

Call toll-free **800-647-8660**

For technical information, order and repair status, and in Mississippi, please call 601-323-5869.

Order any product from MFJ and try it. If not delighted, return within 30 days for a prompt refund (less shipping).

Order today. Money back if not delighted. One year unconditional guarantee. Add \$2.00 shipping/handling.

Order By Mail or Call TOLL FREE 800-647-8660 and Charge It On



MFJ ENTERPRISES

P. O. BOX 494
MISSISSIPPI STATE, MISSISSIPPI 39762

ham radio

magazine

JUNE 1978

volume 11, number 6

T. H. Tenney, Jr., W1NLB
publisher

James R. Fisk, W1HR
editor-in-chief

editorial staff

Martin Hanft, WB1CHQ
administrative editor

Charles J. Carroll, K1XX
Patricia A. Hawes, WA1WPM
Alfred Wilson, W6NIF
assistant editors

Thomas F. McMullen, Jr., W1SL
Joseph J. Schroeder, W9JUV
associate editors

Wayne T. Pierce, K3SUK
cover

publishing staff

C. Edward Buffington, WB1AMU
assistant publisher

Fred D. Moller, Jr., WA1USO
advertising manager

James H. Gray, W1XU
assistant advertising manager

Therese R. Bourgault
circulation manager

ham radio magazine
is published monthly by
Communications Technology, Inc
Greenville, New Hampshire 03048
Telephone: 603-878-1441

subscription rates

U. S. and Canada: one year, \$12.00
two years, \$22.00
three years, \$30.00

Europe, Japan, Africa:
(via Air Forwarding Service)
one year, \$25.00

North America, South America, Australia
and Asia (except Japan):
(via Surface Mail)
one year, \$18.00

foreign subscription agents

Foreign subscription agents are
listed on page 117

Microfilm copies
are available from
University Microfilms, International
Ann Arbor, Michigan 48106
Order publication number 3076

Cassette tapes of selected articles
from ham radio are available to the
blind and physically handicapped
from Recorded Periodicals
919 Walnut Street, 8th Floor
Philadelphia, Pennsylvania 19107

Copyright 1978 by
Communications Technology, Inc
Title registered at U. S. Patent Office

Second-class postage
paid at Greenville, N. H. 03048
and at additional mailing offices
Publication number 233340

hr

contents

10 RTTY SELCOM

Robert C. Clark, K9HVW
Archie C. Clark, WB4KUR
Fred R. Scalf, K4EID

20 Oscar 8 receiving preamplifier

Mark S. Pride, K1RX
Kenneth V. Puglia

26 single IC Touch-Tone decoder

Lawrence Nickel, W3QG

33 antenna guying

Marchal H. Caldwell, Sr., W6RTK

36 Colpitts vfo design

Maurizio Gramigni, I2BVZ

40 rf choke performance

Courtney Hall, WA5SNZ

44 preventing transmitter rf leakage

John E. Becker, K9MM

**48 vertical antenna
for portable communications**

John S. Jolly, WA7NWL

52 pi network design

Irvin M. Hoff, W6FFC

**68 satellite tracking equations
for Texas Instruments calculators**

Charles F. Milazzo, KP4MD

74 protecting solid-state devices

William J. Prudhomme, WB5DEP

**81 instantaneous shutdown
for high current power supplies**

Alan S. Nusbaum, W6GB

84 command debugging circuit

J. Thomas Norman, WA7FHY

87 grid-dip meter

William A. Wildenhein, W8YFB

92 vhf prescaler packaging

Alan Smith, W8CHK

94 precision voltmeter calibrator

Hubert Woods

96 the gyrator: synthetic inductor

John M. Loughmiller, WB9ATW

- | | |
|-----------------------|--------------------|
| 4 a second look | 102 letters |
| 142 advertisers index | 104 new products |
| 117 flea market | 142 reader service |
| 132 ham mart | 6 stop press |
| 98 ham notebook | |

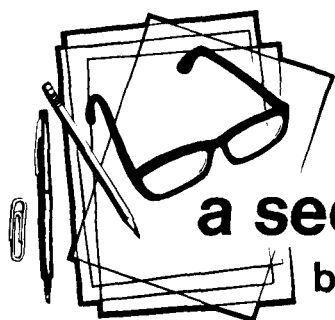

a second look

by Jim Fisk

A group of atomic physicists at Western Washington University has predicted that sometime this year the first message through the earth, rather than around it by way of the ionosphere, will be transmitted along a beam of neutrino particles from a particle accelerator. The neutrino is one of the fundamental sub-atomic particles, but one of the more elusive ones — Wolfgang Pauli first proposed its existence on theoretical grounds in 1930; Enrico Fermi christened the new particle the neutrino (for “little neutral one”), but it wasn’t until 26 years later, in 1956, that it was first detected by scientists.

The interaction of neutrinos with ordinary matter is so weak that, according to classical theory, a neutrino could pass through a block of lead that stretched from here to the nearest star without disturbing any of the atoms in its path. Since the neutrino carries no charge and has no mass (or nearly no mass, scientists aren’t sure), it evaded traditional particle detection methods simply by passing through them without affecting them in any way. Billions of neutrinos from the sun pass through your body every second, day and night, but it’s estimated that a neutrino interacts with one of the atoms in your body only about once every ten years. It’s no wonder it took 26 years to detect the neutrino’s presence!

While the average neutrino is capable of passing through most of the matter of the universe without slowing down or losing any of its energy, it’s been found that neutrinos fired in eight-second bursts from a high-energy particle accelerator occasionally collide with other particles, at the rate of about one collision for every 17 tons of matter that the beam penetrates. Although neutrinos cannot be detected directly, the particle debris, light, and noise generated by their collisions can be. When a beam of neutrinos is passed through a large volume of water, all along its path some of the collision products emit a forward cone of Cerenkov photons which can be detected by a light collector-phototube system. Prototype experiments using Cerenkov detectors to intercept cosmic neutrinos 1000 meters below the ocean’s surface have already been carried out.

In experiments at the 400-billion-electron-volt proton accelerator of the Fermi National Accelerator Laboratory in Illinois, a 20-microsecond pulse of protons is directed into a bar of aluminum — the resulting atomic collisions produce about 10-billion neutrinos per pulse. The beam of neutrinos generates about one reaction per pulse in a bubble chamber containing 25 tons of liquid neon one kilometer away. With a grid of Cerenkov detectors in a large body of water it’s predicted that a greater number of reactions per pulse would be detected. If information could be encoded into pulses of the neutrino beam, theoretically a message could be received and decoded virtually any distance away.

In the experiment suggested by the group in Washington, a pulsed neutrino beam from the Fermi Lab accelerator would be directed downward at an angle of about 12 degrees so the beam would pass through the earth and emerge in Puget Sound, nearly 3000 kilometers away. The detector-target would consist of the approximately one-million tons of water in Puget Sound where showers of particles would be recorded with each neutrino collision. The tiny flashes of light from the Cerenkov photons would be recorded and translated into the original message. Funding for the experiment is being considered by a number of government agencies, including the Navy, which is interested in applications of the technique for deep-water communications with nuclear submarines.

An analysis by the Naval Research Laboratory has shown that, if the energy level of the Fermi accelerator was increased to 1000-billion electron volts, with improved beam focusing, the neutrino event rates could be increased by a factor of 10. By using synchronous detection techniques and Cerenkov photo detectors 3000 meters below the surface of the ocean (where they’re not bothered by ambient light), it is expected that one 15-bit message per pulse could be transmitted with very low error rates. With one neutrino pulse every 8 seconds, this represents a message rate of 6750 bits per hour. Compared with other methods of communications, this is slow, but unlike radio communications, neutrino beams can’t be blocked, they’re not affected by solar storms nor dependent on the ionosphere, and they travel great distances with no loss of power.

Jim Fisk, W1HR
editor-in-chief

IC-211, the 2meter Maximizer

COMPUTER-COMPATIBLE 4 MHz TRANSCEIVER WITH 2 VFO'S



ICOM's **IC-211** maximizes band coverage, speed, performance and convenience like no other transceiver in the 2 meter world. This Maximizer's single-knob dial provides all 4 MHz in a flash, right to your single fingertip! The **IC-211** maximizes read-out speed with positively no time lag or backlash in display stability, even in modes using 100 Hz steps. The **IC-211**'s freewheeling dial, with its superb inertia clutch, is instantly coordinated with the high speed, computer circuitry controlled synthesizer's seven digit read-out using an optical chopper. There is absolutely no mechanical connection between the smooth, bearing mounted flywheel knob and the **two dual-tracking VFO's**, which come built into your **IC-211**.

- **Single knob frequency selection:** The **IC-211** is synthesized with convenient single knob frequency selection over the entire 4 MHz. No more fussing with two or more knobs just to check what is going on around the band. One easy spin of the dial does it all.
- **Two VFO's built in:** The second VFO, which is an optional tack-on with most other transceivers, is an integral feature in every **IC-211**.
- **Variable offset:** Any offset from 10 KHz through 4 MHz, in multiples of 10 KHz, can be programmed with the LSI synthesizer.
- **Remote programming:** The **IC-211** LSI chip provides for input of touch tone and programming data from an external source, such as the microprocessor controlled accessory which will also provide scan and other functions (available summer '78). Computer control from a PIA interface is also possible (data available on request).
- **FM stability on SSB and CW:** The **IC-211** synthesis of 100 Hz steps makes SSB as stable as FM. This extended range of operation is attracting many FM'ers who have been operating on the direct channels and have now discovered SSB.

The **IC-211** is the very best and most versatile 2 meter transceiver made: that's all. For more information and your own hands-on demonstration, see your ICOM dealer. While maximizing performance, the **IC-211** minimizes impatience: yours is ready for delivery now.

Maximize the new repeater band: both the **IC-211** and the **IC-245/88B** operate the new FCC repeater spectrum with no modification.

All ICOM radios significantly exceed FCC specifications limiting spurious emissions.

Specifications: Frequency Coverage: 144.00 to 148.00 MHz; Modes: SSB (A3J), FM (F3), CW (A1); Supply Voltage: DC 13.8V - 15%, AC 117V - 10%; Size: 111mm(h) x 241mm(w) x 264mm(d); Weight: 6.8 Kg; TX Output: A3J, 10W (PEP), A1 & F3, 10W; Spurious Radiation: 60 dB below Carrier; Microphone Impedance: 600 Ohms; Sensitivity: A3J & A1, 0.5 microvolt 10 dB S+N/N; F3, 0.6 microvolt for 20 dB quieting; Spurious Response: 60 dB or better; Synthesizer Frequency Range: 144.00 MHz to 148.00 MHz; Synthesizer Step Size: 100 Hz or 5 KHz for SSB, 5 KHz for FM.

Supplied with hand held microphone, AC cord, DC cord, fuses and owner's manual.

Specifications are subject to change without notice.

HF/VHF/UHF AMATEUR AND MARINE COMMUNICATION EQUIPMENT

DISTRIBUTED BY:



ICOM

ICOM WEST, INC.
Suite 3
13256 Northrup Way
Bellevue, Wash. 98005
(206) 747-9020

ICOM EAST, INC.
Suite 307
3331 Towerwood Drive
Dallas, Texas 75234
(214) 620-2780

ICOM CANADA
7087 Victoria Drive
Vancouver B.C. V5P 3Y9
Canada
(604) 321-1833



SERIOUS QUESTIONS ABOUT AUTOPATCHES and the apparent increase of business-type communications on the Amateur bands were raised in an April FCC release, which likened "telephone interconnection at Amateur stations" with "the situation in the Personal and Business Radio Services." Though there were some text problems with the release as issued — the Personal Radio Division has requested that it be corrected and re-released — it strongly points up growing Commission concern with this area of Amateur Radio.

Autopatches And Reverse Autopatches in particular were discussed at some length in the FCC document. For example, it pointed out that the regulations require a control operator be on duty whenever autopatching or reverse autopatching occurs, effectively prohibiting autopatch use when a repeater is operating in "automatic control." It further stated that "all calls not initiated at an amateur station had to be screened by the control operator before being placed on the air." Though a revised release is to be issued shortly, it's obvious that autopatch operators and users should start now to tighten up their operations.

Autopatch Financing could raise still another sticky question with respect to ITT tariffs. W0MKZ points out in Boulder QSP, if money is collected from users specifically to pay for their use of the autopatch. It appears clubs or other groups with autopatch repeaters would be on firmer ground if autopatch costs were to be covered as just another expense item financed from club revenues.

THE FCC'S COMPUTER has mistakenly issued duplicate licenses to approximately 3000 new amateurs. Some of those who received the dual licenses received two call signs, others received two licenses with the same call letters. To end the confusion, the FCC has ruled that amateurs with two tickets are to use the license with the later date, and set aside the one with the earlier date until informed by the FCC what is to be done with it.

Two Sets Of "Doubles" were mailed out. The first sets are dated February 28 and March 3, the second pairs are dated March 17 and 21. The FCC should have been in touch by letter with all amateurs who received two licenses.

THE 3-CM AMATEUR BAND IS THREATENED by "Amateur Radio" manufacturers who are planning to make and market police-radar jammers under the "Amateur Radio" label. The March issue of Communications Retailing described one such unit being sold as a "radar calibrator," quotes a company official as saying they may designate their jammer as amateur equipment to escape FCC's controls on such items and it should be on the market in May.

Whatever The Result of all this, amateurs seem likely (as with the 10-meter linear ban) to be the losers in the end. Even the radar detector manufacturers oppose the jammers, according to Communications Retailing, on the grounds that they're almost certain to generate legal sanctions that would include detectors.

NEW CHIEF OF THE FCC'S Safety and Special Services Bureau is Carlos Roberts, replacing Charley Higginbotham whose retirement became official April 7. Roberts comes to Safety and Special Services from the FCC's Office of Plans and Policy, where he's been Chief since July, 1975. He's been with the FCC since graduating from college in 1970, starting with the Field Operations Bureau. In 1973 he supervised a Special Enforcement Facility for CB rules, so he's no stranger to either CB or Amateur Radio.

R. L. DRAKE HAS OPPOSED FCC'S ban on 10-meter linears with a Petition for Reconsideration filed near the end of April. The thrust of Drake's objection to the ban is that compliance with the Type Acceptance requirements will effectively prevent an amateur amplifier's use by a CBER, so the ban unnecessarily penalizes Amateurs and those who serve the Amateur market. Several other major amplifier manufacturers were actively considering similar action, with ETO also filing a Petition for Reconsideration.

HY-GAIN HAS BEEN PURCHASED BY TELEX and planned to be back in production May 1 as a division of the Telex Corporation. The product lines will include amateur antennas and electronics, marine antennas and gear, government and commercial antennas, and CB antennas. Notably lacking will be the CB electronics that caused so many of their problems in recent months.

FIRST 2-METER E-M-E contact between North and South America was logged the end of March by W4WD and YV5ZZ. Fine signals were reported at both ends. K1WHS worked YV5ZZ an hour later.

Rare States On 70 cm E-M-E (ND, SD, WY, MT, ID) will be provided by K2UYH during a mid-June cross-country trek. Al will appreciate set-up and operating help — write Dr. Allen Katz, Department of Engineering Technology, Trenton State College, Trenton, New Jersey 08625.

THE SMITH CHART ARTICLE in the March ham radio quoted an incorrect price for packages of 100 charts. The correct price is \$6.50 per hundred from Analog Instruments Company, Post Office Box 808, New Providence, New Jersey 07974.

Look closely at the new MT-3000A. You've never seen anything like it.

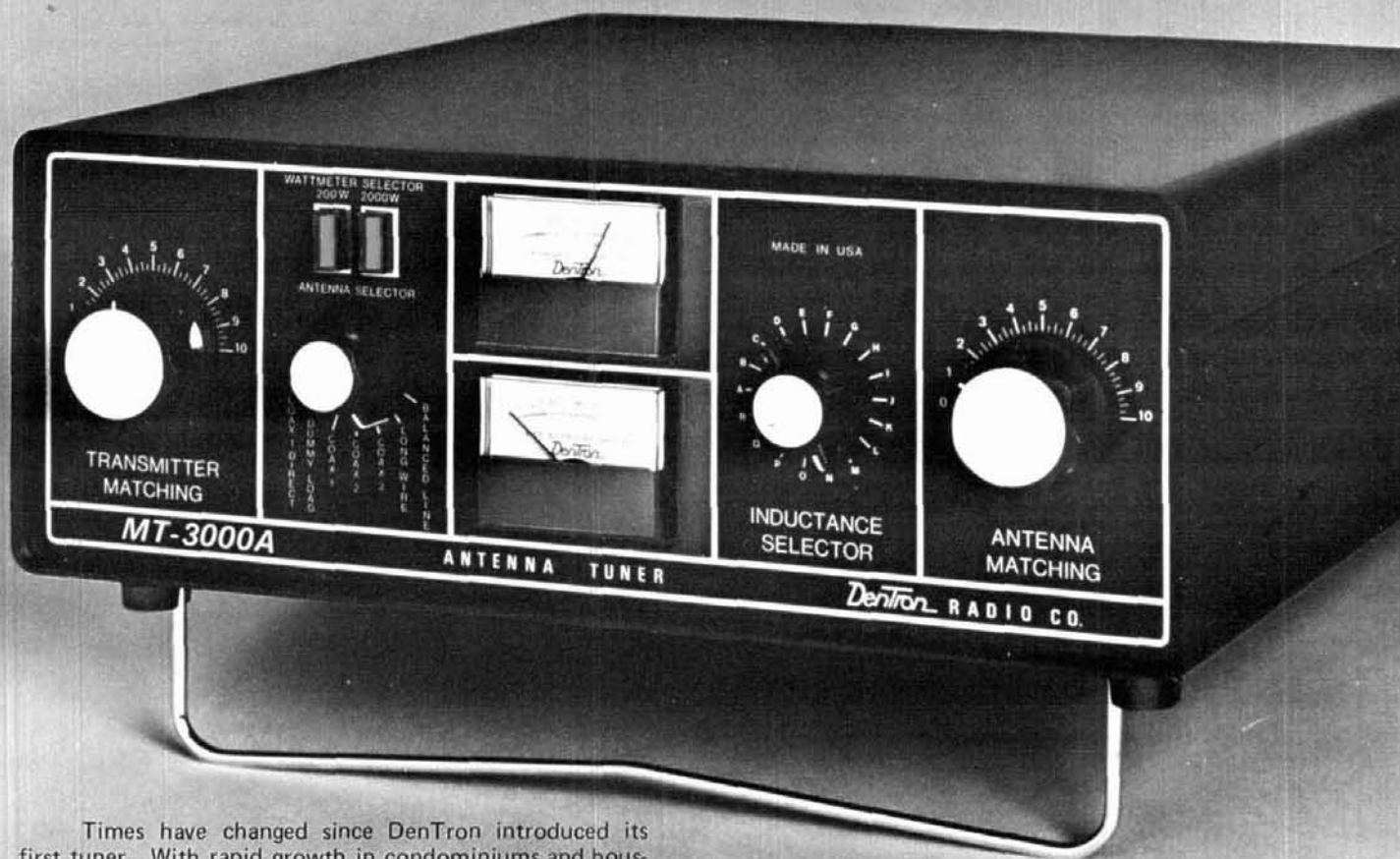

Times have changed since DenTron introduced its first tuner. With rapid growth in condominiums and housing developments, we have new problems that require new solutions.

DenTron decided to rethink the tuner and what its total capabilities should be.

The MT-3000A is a capsulized solution to many problems. It incorporates 4 unique features to give you the most versatile antenna tuner ever built.

First, as a rugged antenna tuner the MT-3000A easily handles a full 3KW pep. It is continuous tuning 1.8-30mc. It matches everything between 160 and 10 meters.

Second, the MT-3000A has built-in dual watt meters.

Third, it has a built-in 50 ohm dummy load for proper exciter adjustment.

Fourth, the antenna selector switch; (a) enables you to by-pass the tuner direct; (b) select the dummy load or 5 other antenna systems, including random wire or balanced feed.

The compact size alone of the MT-3000A (5½" x 14" x 14") makes it revolutionary. Combine that with its four built-in accessories and we're sure you'll agree that the MT-3000A is one of the most innovative and exciting instruments offered for amateur use.

At **\$349.50** the MT-3000A is not inexpensive. But it is less than you'd expect to pay for each of these accessories separately.

As unique as this tuner is, there are many things it shares with all DenTron products. It is built with the same meticulous attention to detail and American craftsmanship that is synonymous with DenTron.

After seeing the outstanding MT-3000A, wouldn't you rather have your problems solved by DenTron?

DenTron
Radio Co., Inc.

2100 Enterprise Parkway
Twinsburg, Ohio 44087
(216)425-3173

IT'S NEW ... IT'S UNIQUE ... AND IT'S TRULY USEFUL. IT'S KENWOOD'S SM-220 STATION MONITOR. THE SM-220'S UNEXCELLED VERSATILITY ALLOWS YOU TO MONITOR YOUR TRANSMISSIONS, MONITOR INCOMING SIGNALS, AND MONITOR THE AMOUNT AND STRENGTH OF BAND ACTIVITY* AND PERFORMS AS A GENERAL-PURPOSE 10 MHz OSCILLOSCOPE, AS WELL.

Kenwood offers this totally unique unit as a perfect compliment to your TS-820S or TS-520S station.** The SM-220, based on a wideband oscilloscope (2 Hz to 10 MHz), permits you to monitor your transmitted signals, thus assuring optimum linearity and maximum performance. With the addition of the BS-5 or BS-8 Pan Display option you will be able to determine visually the location and strength of adjacent signals without tuning your receiver off frequency. The choice of options allows you to adapt the SM-220 to either the TS-820S or TS-520S.

The SM-220 has a built-in two-tone audio generator with full provisions for tuning your exciter and linear amplifier (160 m through 2 m).

All this costs little more than a general-purpose oscilloscope. And, of course, it's pure Kenwood quality.

*With BS-5 or BS-8 option

**For other models check with appropriate manufacturer for compatibility.

SM-220



Function: Selects operation mode: OSC/RTTY. General testing of station equipment, experimental design of new equipment, or troubleshooting; display of receiver IF output allows you to give "signal quality reports".

Power: ON indicator. Power switch.

Intensity: Controls brightness of scope display.

Band Scope: (Pan Display) With BS-5 or BS-8 option, allows you to "see" the signals on both sides of your operating frequency without tuning your receiver off frequency. Useful for determining "band conditions", band crowding, source of interference from adjacent stations ... a visual display of what you would hear if you tuned across the band, without having to touch your receiver's dial.

Focus: Controls sharpness of scope display.

Vertical Attenuator: Precision step attenuator (gain control) switch adjusts vertical input level.

Vertical Input: Accepts IF input, RTTY input or oscilloscope input.

Vertical Gain: Potentiometer to fine-adjust vertical input level.

Adjusts display along vertical axis.



RF Attenuator: Level control used in MONI/TRAP mode.

Tone: Step switch selects Wien bridge tone generators: 1000 Hz, 1575 Hz or both tones simultaneously.

Out: Output of the audio generator can be connected to the transceiver's microphone input for "two-tone test". Also for trapezoidal test of transceiver linear amplifier.

Synchronization Marker: Selects internal or external sync (similar to horizontal hold on TV). Turns On or Off the built-in marker which shows operator where his receiver is actually tuned.

Scan Width: Selects width of "window" or receive band display when using the Pan Display option. (100 kHz or 20 kHz)

Variable sweep control/External gain: Controls (1) sweep speed of display in any sweep range, (2) optional Pan Display (Band Scope) speed of display, (3) level of horizontal input/external synchronization input when sweep range is in RTTY/Ext or Trap.

Horizontal Input/External Sync: Accepts either (1) RTTY input for tuning, (2) external sync input for test (oscilloscope functions), (3) external oscillator for Lissajous display.

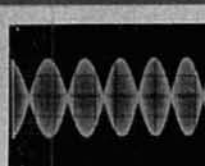

Two-Tone Wave Envelope For "performance" tune-ups or checking proper transceiver operation.

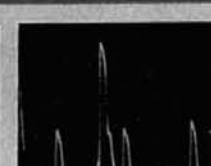

Pan Display Use to check source of interference during "QSO" without moving off-frequency. Also determines location and strength of adjacent frequencies. (Requires BS-5 or BS-8 option)

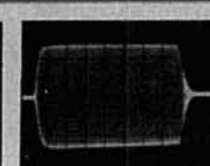

Keyed Waveform Shows detail of CW keying. Use to monitor the quality of your CW note. (Photo shows ideal waveform produced by TS-820S.)

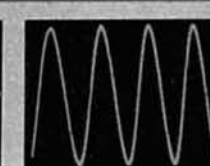

Oscilloscope Operation (1 kHz) Oscillator function allows Sine, square wave, Lissajous patterns for testing or design work.

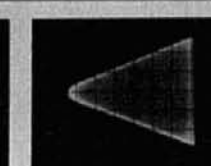

Trapezoid (TS-820S w/ TL-922) Shows linearity of power amplifier. Used primarily for testing.



Wave Envelope shows full SSB voice modulation, with processor on (full compression), and "clean signal" at full power.

The TS-520S... the most popular Amateur Radio transceiver in the world... provides a foundation for an expanding series of accessories designed to please any ham... from Novice to Amateur Extra.

TS-520S

The TS-520S transceiver provides full transmit and receive coverage of all Amateur bands from 160 through 10 meters. It also receives 15.0 (WWV) to 15.5 MHz and another 500-kHz range of your choice in the auxiliary band position. With the optional DG-5, you have a large digital frequency readout when transmitting and receiving, and the DG-5 also doubles as a 40-MHz frequency counter. The TS-520S includes a built-in AC power supply, and, with the addition of the optional DS-1A DC-DC converter, it can function as a mobile rig. It features a very effective noise blanker, RIT, eight-pole crystal filter, 25-kHz calibrator, front-panel carrier level control, semi-break-in CW with sidetone, built-in speaker, heater switch, 20-dB RF attenuator and easy phone-patch connection. RF input power is 200 W PEP on SSB and 160 W DC on CW. Carrier suppression is better than -40 dB and sideband suppression is better than -50 dB. Spurious radiation is less than -40 dB. Receiver sensitivity is 0.25 μ V for 10 dB (S+N)/N. Selectivity is 2.4 kHz at -6 dB/4.4 kHz at -60 dB and, with the optional CW-520 CW filter, is 0.5 kHz at -6 dB/1.5 kHz at -60 dB.

See your local Authorized Kenwood Dealer for more information, and a super deal!



A great station... at an affordable price! The TS-520S with its companion accessories... including two new units. The AT-200 antenna tuner provides a versatile tool in any station. The other is the TV-520S, Kenwood's 2 meter transverter for SSB and CW operation from 146 to 148 MHz.

TRIO-KENWOOD COMMUNICATIONS INC.
1111 WEST WALNUT/COMPTON, CA 90220

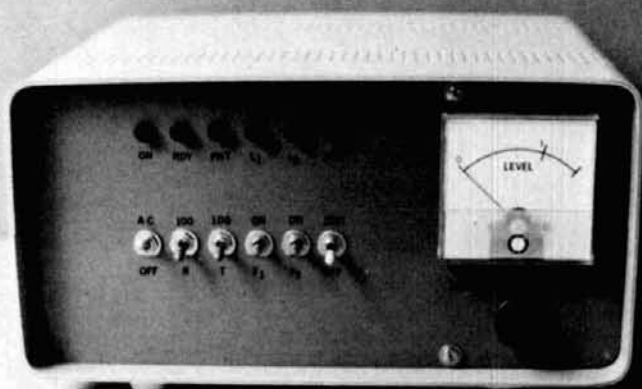

RTTY SELCOM

Discussion of the
RTTY SELCOM —
an advanced
TTL design,
providing selective
character recognition

One of the first applications of digital logic to RTTY was the RTL SELCAL described by Lamb.¹ Capable of recognizing a single sequence of four characters, it proved very laborious and costly, since there were over 300 wired connections to be made in the basic unit. This concept, however, was expanded and translated into TTL form in the TTL SELCAL described by Branscome.² Although this unit was constructionally simpler, even with expanded capabilities, it still did not overcome the cumbersome decoding process, or provide for easy expandability.

Shortly after the TTL SELCAL was introduced, the CATC group³ tackled the problem of sequential character recognition, hoping to overcome the two main problems presented by the TTL SELCAL. By 1972 the objectives had been met, and circuit boards were fabricated for what was known as SELCOM I. This unit dramatically expanded the flexibility to decode all 32 Baudot characters and could recognize nearly unlimited strings of characters. Many of the sequences were to be used as *selective* station control commands, hence the name.

Probably the most powerful discrete logic sequential decoder ever developed, the SELCOM was also far easier to program than the earlier SELCALs since only one connection, instead of five, was required per character. This ease in decoding had been achieved by the use of a 1-of-32 decoder. In this manner, the Baudot character set was decoded, providing access to characters, rather than the bits as in the SELCAL versions. And, to provide expandability, a 32-character bus was connected to every sequential decoder board. This bus could be expanded as desired since each line of the bus was capable of handling up to 500 TTL loads.

In May, 1973, the discrete bus drivers were replaced with TTL buffers, lowering the drive to 30 instead of 500 loads. Even with this change, SELCOM II still retained the versatile bus structure of the original version.

Version III of the SELCOM incorporated a MOS UAR/T. This chip, a natural for the SELCOM, had already been in use for several years by various computer manufacturers, but the single quantity price was prohibitively high for amateur work until about December, 1973. Offering significant simplification, the UAR/T provided all functions except those of the clock and character decoders, and in addition, offered new functions not available in earlier versions of the SELCAL or SELCOM. They included regeneration of the received RTTY signal, speed conversion, and the ability to handle any code of 5 through 8 bits with only a simple jumper change.

By Robert C. Clark, K9HVW, Archie Lamb, WB4KUR, and Fred R. Scalf, K4EID. Mr. Clark may be reached at 930 Chestwood Avenue, Tallahassee, Florida 32303.

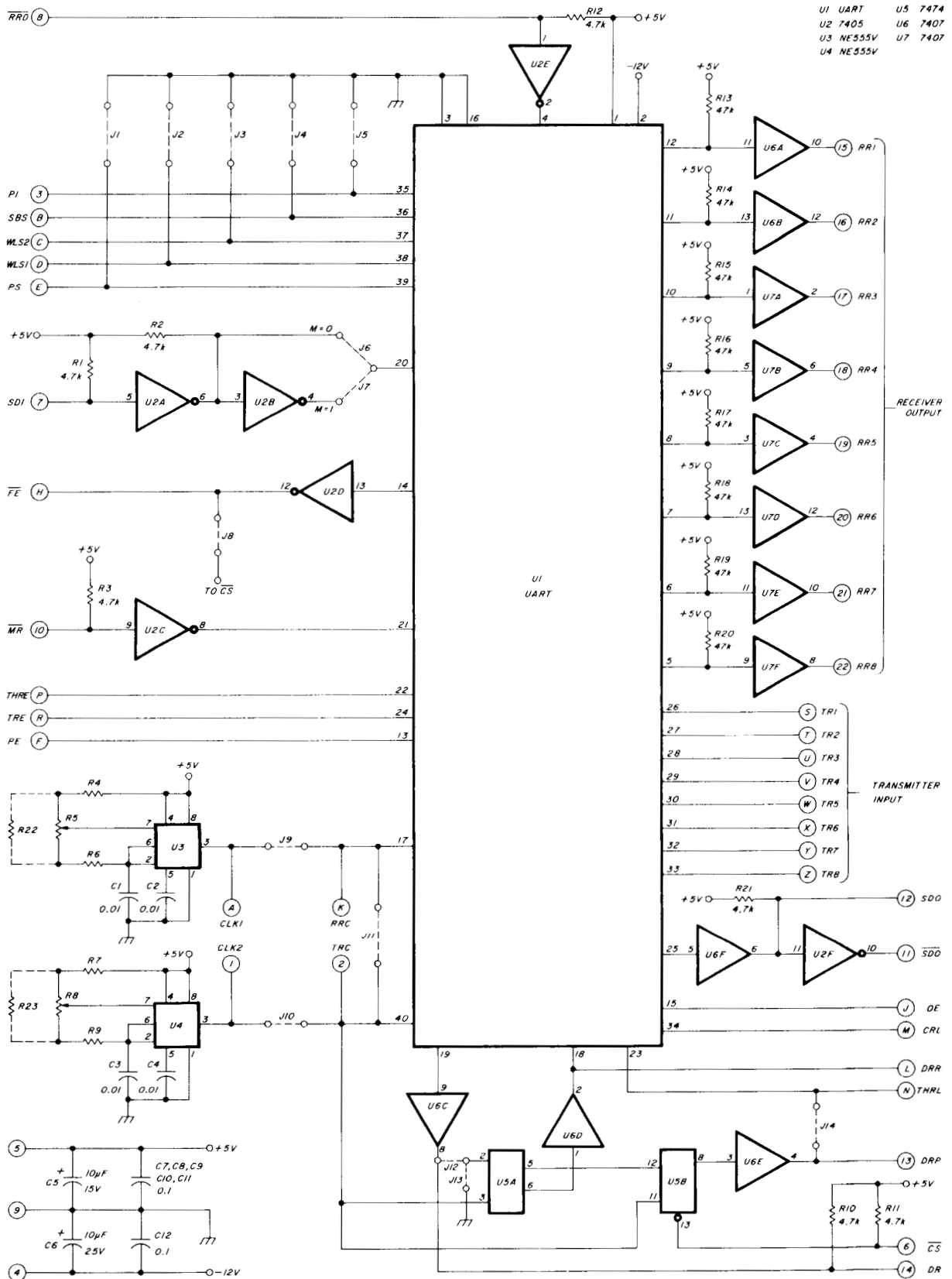

fig. 1. Schematic diagram of the DU-200 Universal UAR/T module. The jumper placement is explained in the text and also *table 1*. The UAR/T is available from either Texas Instruments or General Instruments. The buffers for the receiver output and flag lines can be eliminated if the lines are used for feeding only one TTL load.

In early 1974, an attempt was made to eliminate the mechanical problems presented by the double-width cards used in earlier SELCOMs. To do this, the versatile bus structure was abandoned in favor of a functional module approach. These modules provided a versatility not possible in the earlier versions of the SELCOM. With the change to single-width cards,

SELCOM IV may be used with 5, 6, 7 or 8 bit codes at speeds up to 9600 bits per second. The following description is for the five-bit Baudot code used for amateur RTTY at 45.45 and 74.2 baud, but the unit is designed for expansion to the full 64-character ASCII code group.

SELCOM features

DU-200 Universal UAR/T. The DU-200 (fig. 1) is not only the heart of the SELCOM system, but also provides a powerful functional module for many other applications as well. It may be used for teleprinter signal regeneration, speed conversion, serial-to-parallel data conversion, parallel-to-serial data conversion, code conversion (Baudot to ASCII, ASCII to Baudot, Baudot to Morse, etc.), and many other ways. All the features of the UAR/T have been made available in the DU-200, either through hard-wired jumpers or through external control. In this way, the same board may be configured as a Baudot or ASCII regenerator, an interface between a serial RTTY station and a parallel I/O port of a microprocessor, a SELCOM, or a wide variety of other applications.

The DU-200 consists of the UAR/T, interface (buffering), control, and clock functions. The UAR/T IC (U1) functions as two nearly independent circuits, a digital receiver and a digital transmitter. The receiver accepts serial data in a particular format (selected by the user), checks for format errors (parity error, missing stop bit, etc.), and outputs the data in a parallel form. The transmitter accepts parallel data, adds start, stop, and parity bits, and sends the data in a serial format at the data rate selected. If the parallel output of the receiver is connected to the parallel input of the transmitter, the unit functions as a regenerator. The two sections may be used independently, but the data format for both sections must be the same. That is, both the receiver and transmitter must operate with the same code, parity, and so on. Under certain conditions they may operate at different speeds.

The UAR/T is capable of accepting data with up to 43 per cent distortion (more in some cases) and re-sending it with less than 1 per cent distortion. Typical teleprinters are capable of accepting less than 30 per cent distortion, while many keyboards and transmitter distributors generate signals with large amounts of distortion. As machines age, their ability to accept distortion is diminished and their ability to produce it is increased. The use of the DU-200 as a regenerative repeater offers improvements to all mechanical teleprinters, keyboards, and transmitter distributors.

Under marginal conditions several undesirable situations may exist with the mechanical teleprinter. Typically, high-frequency propagation phenomena tend to add distortion to that which already exists on the transmitted signal. For this reason, it is highly de-

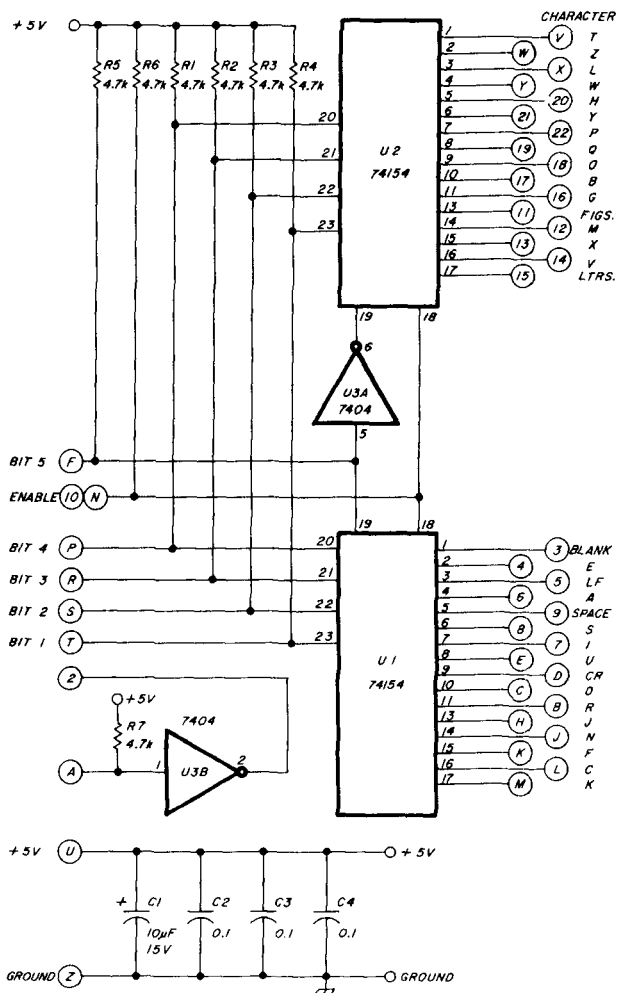

fig. 2. The DU-210 character decoder uses two 1-of-16 decoders as a 1-of-32 decoder. Both 74154s receive bits 1 through 4, while bit 5 is used to select the appropriate 74154. The single inverter is provided if more than one DU-210 decoder is used.

the modules of SELCOM IV are now the same physical size as the DT-500⁴ and DT-600 boards.

The group of modules to be described from SELCOM IV, or individual modules may be used in other applications. The modules include:

1. DU-200 Universal UAR/T
2. DU-210 Expandable 1-of-32 Character decoder
3. DU-220 Sequential Decoder
4. DU-300 Mini-SELCOM

sirable that the transmitted signal have a minimum of distortion. If the DU-200 is used to process the transmitted signal, then this criteria will be met. Even if the transmitted signal is perfect, distortion will be added by the time the signal reaches the receiver.

Another problem that exists with a mechanical teleprinter is that a short noise pulse may be read as a *start*. When this happens, a clutch is released, beginning the sequence of events which decode and print a character. The teleprinter shaft must complete one full revolution before it can recover from this premature start. If the real start bit is received during this revolution, the printer will not be able to get back in synchronization with the sending station. In such a situation, the printer may print *garbage* for several characters. Most brands of the UAR/T though, after receiving what appears to be a start bit, recheck to determine that the start bit is still at the appropriate level in the middle of the bit. If the start bit is not valid, then the UAR/T is immediately reset. Thus, the probability of the receiving station staying in synchronization with the sending station is greatly improved.

Another undesirable condition exists when the received signal drops below the noise level and garble is printed. If the signal is not capable of providing the necessary information for character recognition, then it is quite likely that the appropriate level will not be maintained during the stop bit. This is termed a Framing Error and the UAR/T provides a flag to indicate this error. The flag may be used to suppress the transfer of the character to the transmitter section. If this feature is selected, the mutilated character will not be printed. A similar feature is available for parity errors on received characters.

The UAR/T will respond only to those characters that appear to be valid RTTY. It will not respond to a steady space (a single *blank* character will be transferred to the transmitter section unless the Framing Error flag has been used to suppress the transfer)

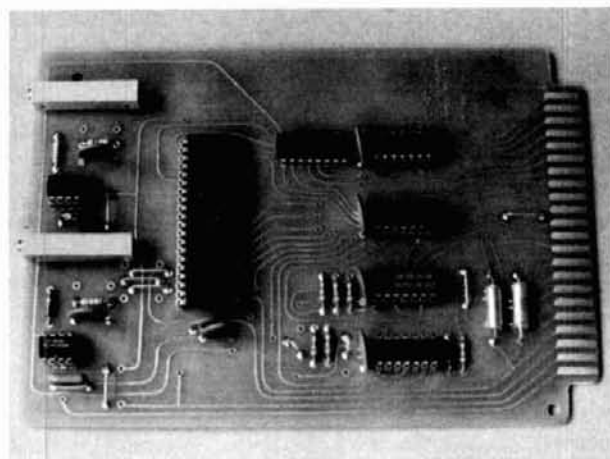

Photograph of the DU-200 Universal UAR/T board.

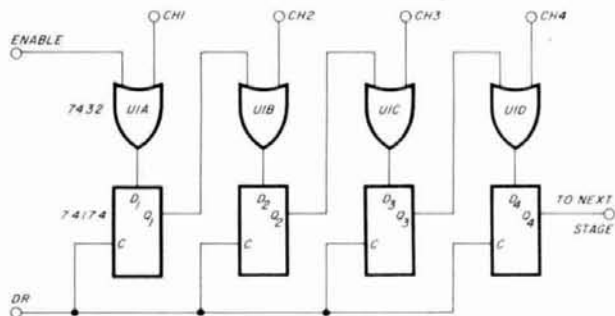

fig. 3. Diagram of the DU-220 sequential decoder. Several similar sections are on each board. Each channel input is connected to the desired character output from the DU-210 decoder.

while most noise and CW will transfer fewer characters to the printer than if the UAR/T were not present. With the DU-200 on-line, the appearance of the page is dramatically improved, with any demodulator.

If the clock applied to the transmitter and receiver sections of the UAR/T are set for different rates, the UAR/T will function as a speed converter. For example, if a 100 wpm (74.2 baud) printer is used, it's possible to receive any speed up to 100 wpm without expensive and noisy gear shifts. By providing a buffer memory between the receiver and transmitter sections, the DU-200 can function as a down converter. Of course, if the size of the buffer is finite, then the UAR/T receiver will deliver characters to the buffer faster than the transmitter section clears them, causing the buffer to overflow. In the case of overflow, the UAR/T provides an Overrun Error flag which may be used to signal an external device to withhold further characters.

DU-210 Character Decoder. The DU-210 (fig. 2) recognizes which one of 32 possible characters has actually been received by the UAR/T in the DU-200. Several DU-210 boards may be used to recognize characters from larger character sets. Two DU-210 boards may be used to recognize the 64 characters of the ASCII-6 subset and four may be used to recognize the 128 characters of the full ASCII set. In fact, the DU-210 may be used in many applications where one particular binary code must be recognized.

Sequential Decoder. The DU-220 (fig. 3) works with the DU-200 and DU-210 to recognize sequences of characters. It might be wired to recognize the station call, setting a latch when the call is received. This latch could be used to prevent the station printer from operating until the call was received. In fact, the DU-220 is capable of detecting a number of sequences, each of which may control some event such as:

1. Turn on reperforator.
2. Turn off reperforator.

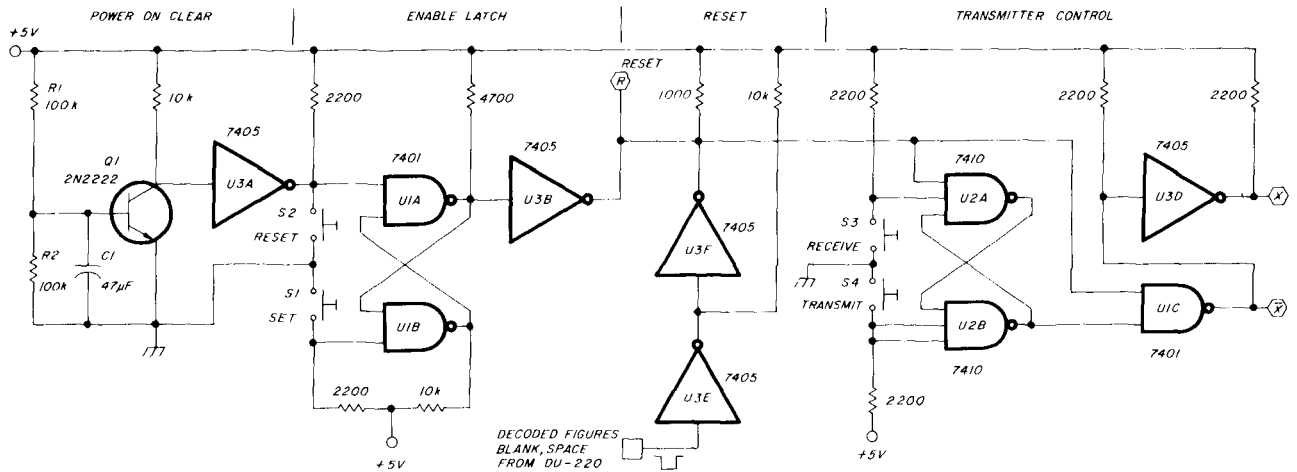

fig. 4. Schematic diagram of the power-up clear and latch circuitry. By using open-collector inverters, the reset line can be fed from several different sources. This circuit ensures that the transmitter control will come up in the transmitter off condition.

3. Start CW identification.
4. Turn transmitter on.
5. Turn transmitter off.

If necessary, these control sequences may be configured so that they will be recognized only when the source is the local keyboard.

The DU-220 is quite versatile in that it may be used to detect a sequence of events independent from the SELCOM system. For instance, the DU-220 might be used to recognize a sequence of digits from a *Touch-Tone** decoder. Certain sequences could be prevented from reaching the telephone lines, with others being used to control repeater functions. In addition, the DU-220 could also be used to recognize a sequence of switch closures in an electronic lock.

circuit description

DU-200 UAR/T Board. Serial data for the UAR/T is first applied to pin 5 of U2A. The input to pin 20 (Serial Data Input) of U1 is jumpered to either pin 4 or pin 6 of U2 depending on the sense of the data (mark

low or mark high). The UAR/T is programmed, by either hard wiring or external devices, as shown in **table 1**.

The speed of the received data is selected by an external clock set to sixteen times the baud rate. For 60 wpm, the clock would be set to $45.45 \text{ Hz} \times 16 = 727.27 \text{ Hz}$. On the first mark to space transition, an internal counter is reset and allowed to count clock pulses. Each brand of UAR/T has some provisions for verifying that the mark to space transition was a valid start bit. If the start is verified, the counter continues, in turn controlling a serial-shift register, so that each received bit is stored in the shift register. At the time of the expected stop bit, another check is performed. If the stop (a mark) is not present at the required time, the Framing Error (FE) flag is raised to indicate an invalid condition. In the same manner, if a parity check has been requested, and the proper parity is not verified, the Parity Error (PE) flag is raised. The Overrun Error (OE) flag is available to indicate that one character has not been removed from the receiver holding register before the next character took its place. These flags may be used to control indicators, keep the character from being printed, or control error-correction schemes.

When a complete character has been received and transferred to the receiver-holding register (only complete characters appear at the receiver holding register output), pin 19 of the UAR/T (Data Ready) goes high to indicate that the character is available in parallel form on pins 5 through 12 of U1. U5 is a two-stage shift register clocked by the receiver clock. The high from pin 19 of U1 (DR) is transferred through U5 after the next two successive clock pulses. The out-

table 1. UAR/T programming information.

function	format	conditions (UART pins)
Code Length	5 bit	pin 37 low, pin 38 low
	6 bit	pin 37 low, pin 38 high
	7 bit	pin 37 high, pin 38 low
	8 bit	pin 37 high, pin 38 high
Parity Selection	Parity	pin 35 low
	No Parity	pin 35 high
Odd/Even Parity	Odd Parity	pin 39 low
	Even Parity	pin 39 high
Stop Bit Select	One Stop Bit	pin 36 low
	Two Stop Bits	pin 36 high (for some manufacturers, a 1.5 bit stop is provided for 5 bit codes).

**Touch-Tone* is a registered trademark of the American Telephone and Telegraph Company.

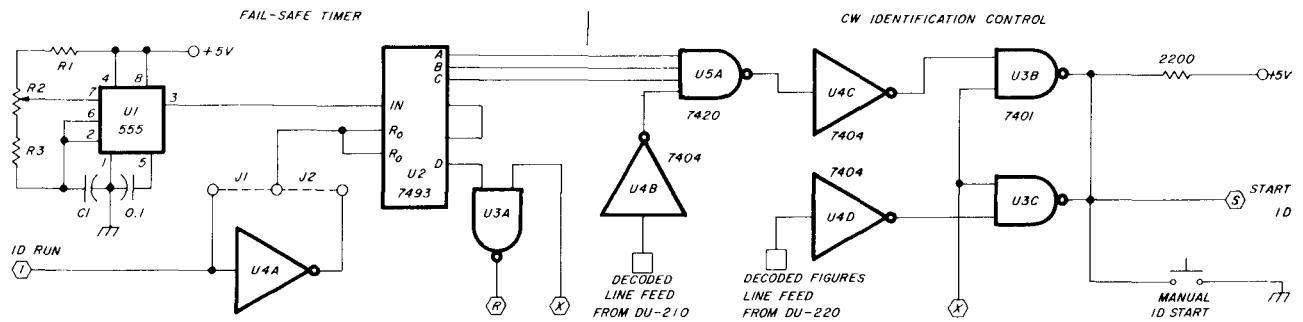

fig. 5. By using this fail-safe timer, the transmitter will be turned off if an identification is not sent every 10 minutes. As with all other diagrams, the power supply connections have not been shown. If the return line from the identification unit is low when the ID is running, J1 should be connected; if high, J2 is connected.

put of the first stage (U5A pin 6) is applied to the *Data Ready Reset* (DRR) of U1, resetting the DR line. In addition, the \bar{Q} output of the second stage feeds the *Transmitter Holding Register Load* (THRL) line of U1, loading the parallel data from the receiver into the transmitter holding register. This action of U5 guarantees that DR stays high for exactly one clock period. Some brands of UAR/T require a rising edge for THRL, while others require a falling edge. The DU-200 provides both a rising and a falling edge, and hence will function with most of the UAR/Ts on the market. The direct clear for the second stage (U5 pin 13) may be used to prevent the character from being loaded into the transmitter holding register. Jumper J8 allows the Framing Error flag to suppress characters with a missing stop pulse. A similar procedure may be used for parity errors and overrun errors.

The UAR/T handles steady spacing in an interesting manner. If J8 is omitted, then a steady space will cause a single blank character to be transferred to the transmitter. No other characters will be transferred to the transmitter until the data line returns to mark and a valid start pulse is detected. If jumper J8 is installed, then no characters will be transferred to the transmitter. Hence, it is not possible for the printer to run open. This action is superior to the anti-space offered on the ST-6 and DT-600.

The character transferred to the transmitter holding register will in turn be transferred to the transmitter register when empty. Notice that the UAR/T may be simultaneously processing 3 characters, sending one character, holding a second character, and receiving a third character. The status of the transmitter registers is indicated by pins 22 (*Transmitter Holding Register Empty*) and 24 (*Transmitter Register Empty*) of U1. When a character reaches the transmitter register it is clocked out in serial form (at pin 25 of U1, *Serial Data Out*) according to the format previously selected, at a speed determined by the transmitter-register clock. If this clock is the same one used for the receiver, then the unit operates as a regenerative repeater. If the clocks are of

different frequencies, then the DU-200 operates as a speed converter. If the receiver speed is higher than the transmitter speed, the characters may arrive at the transmitter holding register faster than they may be accepted and a buffer memory must be provided to avoid overrun.

Two clocks are installed on the DU-200 board. In addition, jumpers are provided so that one clock may be used to operate both the receiver and transmitter, or a separate clock may be provided for each. It is also possible to supply clock signals from an external source. A crystal-controlled clock, supplying multiple baud rates, has been designed as part of the CATC line. The 555 IC (U3 and U4) has proven to be adequate as a clock, as long as the ambient temperature is relatively stable. Wide frequency excursions can be expected with wide temperature variations. Most of this frequency shift can be attributed to the thermal characteristics of the resistors and the capacitor which form the RC timing portion of the oscillator. Choice of components, to minimize this shift, will improve the drift characteristics of the oscillator. A polystyrene capacitor is recommended. Also, metal-film resistors will show a significant improvement over the carbon composition types. The configuration of the timing resistors (R4, R5, and R6 for U3) was chosen for stability and is superior to most shown in other articles.

Oscillator frequency is the only adjustment required for the DU-200. The frequency should be set in accordance with **table 2**, while measuring at pin 3 of the 555.

Since the UAR/T is only capable of sinking one TTL load, buffering has been provided on the output and flag lines. If only one load is to be connected to any

table 2. Oscillator frequency of the 555 timer.

speed	baud rate	clock frequency
60 wpm	45.45	727.273 Hz
European	50.00	800.00 Hz
75 wpm	56.83	909.280 Hz
100 wpm	74.18	1186.880 Hz

UAR/T output, and none of the flags or control signals are to be used externally, then U6 and U7 may be eliminated and a jumper used to complete the circuit.

The UAR/T is available from a number of manufacturers. The Texas Instruments TMS-6011NC, General Instrument AY-5-1013, and the Western Digital TR-1602A have all been tested in the DU-200. Difficulties have been experienced with the TR-1602A

The DU-220 Sequential Decoder. As shown in **fig. 3**, selected character lines from the DU-210 are connected to the inputs of the DU-220. Suppose that the enable line of the DU-220 is low and that characters A, B, C, and D from the DU-210 have been connected to CH1, CH2, CH3, and CH4 respectively of the DU-220. When the DU-200 receives an A, it is recognized by the DU-210, and the CH1 line of the DU-220 pulled low. Only when both inputs of U1A are pulled

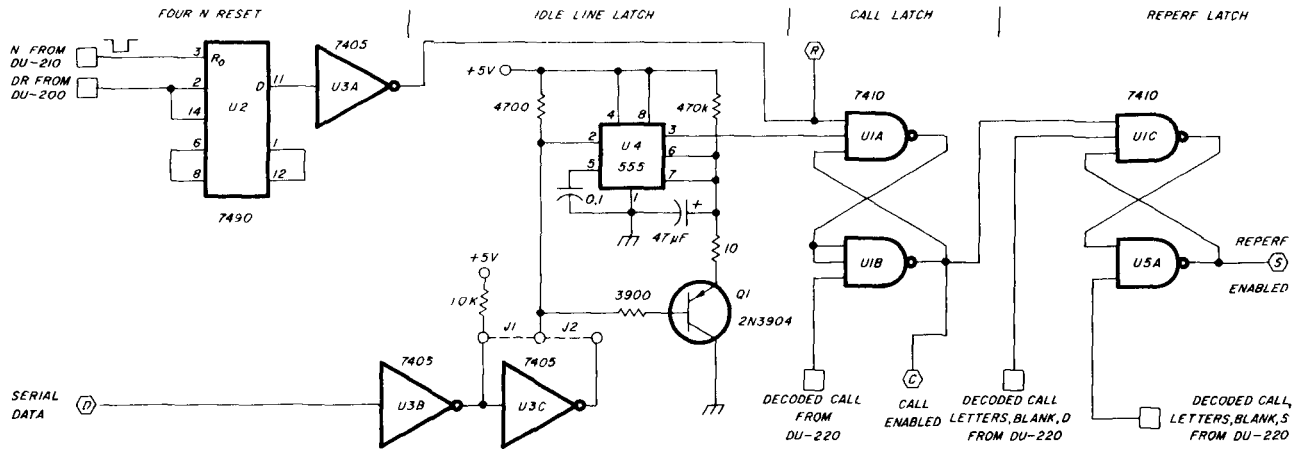

fig. 6. The printer-control portion prevents the printer from operating until the correct sequence of letters is received and the call latch is set. This latch is reset by a four N reset, the idle line reset, or by the normal reset line. The serial data for the idle line reset can be either high or low, with the appropriate jumper connected. For a mark low, use J1 and for mark high, use J2.

when the received data did not have a stop bit. Therefore, only the TMS-6011NC and AY-5-1013 are recommended.

The DU-210. The buffered outputs of the UAR/T receiver-holding register (RR1 through RR8 on the DU-200 board) are connected to the one-of-32 decoder on the DU-210 board. Two 74154 (U1 and U2) decoders are used. The first four bits of the received character are used to address the two decoders, while the fifth bit is used to select one of the decoders. When a decoder is selected (pins 18 and 19 low) only one of the output pins will be low. Hence, if the enable line of the DU-210 is held low, then only one of the 32 output lines will be low for any five-bit binary code on the input lines. The characters of the Baudot set have been shown on the output lines in **fig. 2**.

Because of the nature of the UAR/T, it is permissible to leave the DU-210 enabled at all times, since only complete characters are available at the output lines of the receiver holding register. There is no need to worry about glitches at the output of the DU-210 as one character replaces another in the DU-200.

Several DU-210 boards may be used for a character set larger than the 32 characters in the Baudot set. In such a case, only one enable input at a time may be allowed to go low. The extra section of U3 has been provided to facilitate such connections.

low does the output go low. This low is presented to the D input of U2A. Shortly after the character is recognized, the DU-200 DR line goes high, indicating that a character has been received and is stable in the receiver holding register. The leading edge of the DR line pulse clocks the D level through to the Q output of the flip flop. Since the other character lines are not low, all other flip flops in the chain will be reset producing a 1 on the Q output. The high from the output of the first D flip flop is used to enable U1B. If the next character is a B, then the other input of U1B is pulled low (the output of U1A will not change until the next DR pulse is received). This output is applied to the D input of U2B and is transferred to the output when the DR line goes high. If the next two characters are C and D, this sequence is continued through to U2D. The low on the output of U2D indicates that A, B, C, and D have been received in that order. If at any time a different character is received, or the characters are not in the right order, the sequential decoder is reset. It will respond *only* to the right characters in the right order. The output of this sequential decoder may then be used to control a number of station control functions.

station control

Power-up Circuitry. When digital equipment is first turned on, latches and flip flops come up in random

states. The portion of the station control logic shown in **fig. 4** is a power-up reset which resets all control functions when the power is first turned on. It also guarantees that automatic features are enabled only when desired by the operator.

The latch formed by U1A and U1B is used to enable any automatic functions. The operator may set or reset this latch with S1 and S2. Q1 and U3A form the power-on clear portion of the circuit. As the five-volt

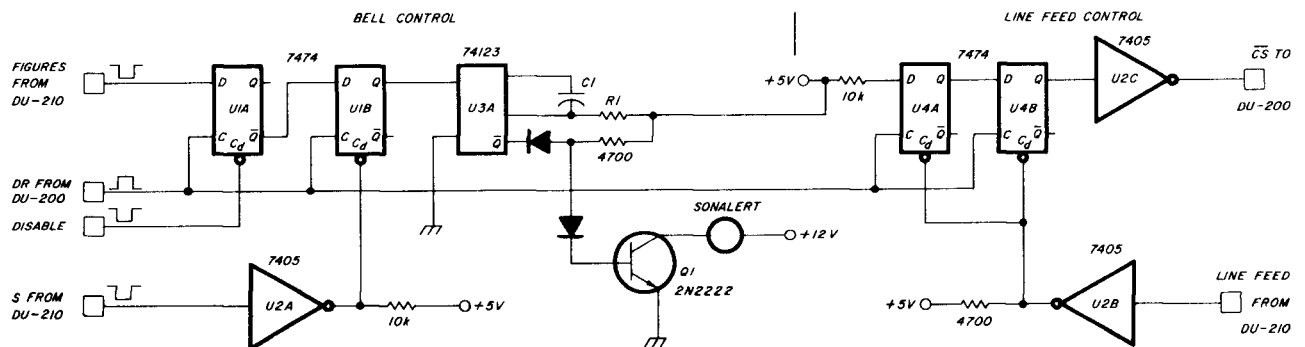

fig. 7. Bell and line-feed control. This circuit prevents the excessive ringing of the bell and the excessive line feeds.

supply starts up from zero, the base of Q1 is held low by the 47 μ F capacitor. The capacitor begins to charge slowly through R1, but the voltage on the capacitor will not turn on Q1 for several seconds. By this time the five-volt supply has stabilized and the U1A latch is reset. The R output is low any time the latch is reset, and is used to disable or reset other circuits in the station control. The 7405 open collector hex inverter allows the output of the enable latch to be "QR tied" with other resets, in this case from U3F. U3E and U3F provide an additional reset from the DU-220, resetting all latches.

Fig. 4 also shows the transmit/receive latch. In addition to being set or reset manually by S3 and S4, the latch is reset from the reset line. This means that the transmitter will be turned off by the power-up reset, a manual reset of the enable latch, or by the reset function (figures, blank, space). The provision for a reset function allows the transmitter to be turned off by a code typed on paper tape. Thus, the operator may cut a tape (concluding with the reset sequence) and then look for something more interesting to do than sit and watch the tape play. At the end of the tape, the reset sequence will turn the transmitter off.

Identification and fail-safe timer. The fail-safe timer (**fig. 5**) guarantees that the transmitter does not stay on the air for an unintentional extended period of time (as when the tape tangles and tears). U1 is another 555 which is enabled only when the transmitter is on the air. The timing components have been chosen so that the period of the oscillator is 1.25 minutes. The pulses from the 555 are applied to

the input of U2, a 7493 four-stage binary counter. When the 7493 has counted eight clock pulses (10 minutes) the D output goes high. This high is inverted by U3A and the resulting low is used to pull the reset line down, resetting the transmit/receive latch.

The counter may be reset to zero at any time by starting the CW identification device. A line from the identification device resets the 7493 when the ID

starts. Options are provided so that the CW run line may be active low or active high.

If the 7493 reaches a count of seven without being reset, then pins 12, 9, and 8 are all high. When the next line feed is received, U5A is enabled, and if the transmitter is on, U3B provides a low, starting the CW identification device. The keyboard and transmitter distributor must be inhibited though while the CW device is running.

It should also be possible for the operator to start a CW identification earlier than 8 minutes and 45 seconds into the transmission. In my case, the sequence figures, line feed is used to insert a CW identification at any time the transmitter is on. The outputs of U3B and U3C are OR tied to provide both automatic and semi-automatic identification. A manual push button is also provided to start the identification.

Printer control. The call latch (**fig. 6**) is mainly used to prevent the station printer from operating until the correct sequence is received. When the DU-220 has recognized the four-character sequence (in my case letters H, V, W) the call latch is set. It may be reset in any of the three different ways: by the sequence N, N, N, N, by a lack of activity on the serial data line, and by the enable latch.

The four N counter (U2) counts DR pulses as long as the N line from the DU-210 is low. When the counter reaches four it is forced to a count of nine. The resultant high on pin 11 is inverted and used to reset the call latch. A unique feature of this counter is that it will automatically reset on the first character after the fourth N.

As all stations have not developed the procedure

of sending four Ns at the end of each transmission (or they might be sent, but not received) another method of resetting the call latch is desired. The method chosen is to monitor the serial data line for mark/space transitions. If no transitions are detected for thirty seconds, the call latch will be reset by the action of U4. This 555 is configured as a monostable with a period of thirty seconds. Each time the serial data line goes to the space level, the 47 μ F capacitor is discharged through Q1 and the sequence begins again. Pin 3 of the 555 goes low after thirty seconds of no transitions and resets the call latch.

Another latch (U1C and U5A) is used to control a reperforator. The sequence letters, H, V, W, letters, blank, S sets the latch and turns the reperforator on (the call and reperforator latches are used to enable and disable the DD-350 selector magnet driver and motor control). The reperf latch is reset by the sequence letters, H, V, W, letters, blank, D or any sequence or event that resets the call latch.

At times it is helpful to control machine functions to save wear and tear both on the operator and machine. One function that is not always valuable is the bell. The operation of the bell on random noise is irritating and the excess use of the bell by some operators is infuriating. Fig. 7 shows one method of controlling the bell function. Initially, the printer bell is disabled and replaced by a Mallory *Sonalert*. U1A and U1B form a 2-bit shift register. The first stage is enabled by a figures function and the count is allowed to continue if the next character is an S. The output of U1B goes high when the sequence figures, S has been received, triggering U3A which controls the time the *Sonalert* is on. The reset input of U1A may be used to inhibit the operation of the bell. One way to use this would be to connect the disable pin to the output of the call latch in fig. 6. In this way, the bell will ring only when the station call has been sent and then the sequence figures, S is received. This should eliminate all bells directed at someone else and the repeated ringing of the bell.

In a similar manner, the machine may be prevented from responding to a sequence of line feeds. U4A and U4B count DR pulses as long as the received character is a line feed. When two consecutive line feeds are received, the output of U4B goes high, is inverted, and the character suppression input of the DU-200 is pulled low, preventing the character from being transferred to the printer. As long as line feeds are sent, no characters will reach the printer. When a character other than a line feed is received, the U4A/U4B counter is reset and characters will again

*As with the DT-500, DT-600, DI-70, and DD-350, boards are being produced by Data Technology Associates, Box 431912, Miami, Florida 33143. The DU-200 board is available with construction notes for \$12.50 plus \$.75 for first-class postage. The format is the same as the DT-600.

reach the printer. If the operator wishes to double space, a sequence of carriage return, line feed, letters, line feed, letters will circumvent the line feed counter and allow two lines to be turned up.

Many other station control functions may be provided for with the SELCOM system. Another possibility would be to establish two frequencies within the same band, one for general calling and the other for third-party traffic. Station A may call station B on the general calling frequency and send a code to switch station B to the traffic frequency. Station A then sends traffic to station B on the second frequency, resetting station A to the calling frequency at the termination of the traffic. The SELCOM can control almost any function that the operator can dream of.

summary

The SELCOM is a powerful digital building block which may be used to implement a wide range of station control applications. In a subsequent article, the DU-300 will be presented. The DU-300 Mini-SELCOM is a single board which provides many of the functions of the DU-200, 210, 220, and the station control board. The DU-300 provides regeneration, speed conversion, call-letter recognition, four N turn-off, printer control, and two other (user defined) functions for station control. Also, the trade-offs between the SELCOM and the Mini-SELCOM will be discussed.

All correspondence should be addressed to Robert Clark at the address indicated at the beginning of this article. All inquiries with a self-addressed stamped envelope will be acknowledged.*

acknowledgements

W0RQI, K4OAH, and W6DNT were very helpful in the design of the early versions of the SELCOM. WA4SNL did the layout for versions II, III, and IV. W8IDJ assisted in preparing tables and parts lists. K4TKU was instrumental in the preparation of high-quality drawings as he has done for other CATC project efforts. WA5IAT was particularly helpful with his work on the control section of the DU-200 and in providing comments on the draft article. We extend our appreciation to each of these who have helped, hoping we have not overlooked anyone.

references

1. Tom Lamb and Bill Malloch, "The SelCal," 73, May, 1968, page 58.
2. Kenneth Branscome, "The TTL SelCal," *The RTTY Journal*, December, 1971, page 7.
3. Robert C. Clark, K9HVW et al, "DT-600 RTTY Demodulator," *ham radio*, February, 1976, page 8.
4. Robert C. Clark, K9HVW, et al, "The DT-500 RTTY Demodulator," *ham radio*, March, 1976, page 24.

ham radio

Full Features and Superior Performance

ST-6000 RTTY DEMODULATOR

Select Rx & Tx Shifts
 Accurately Tuned Rx Filters
 Crystal Controlled Tx Tones
 True Transceive Operation

Invert Both Rx Demod,
 and Tx Tones

Data Status Indicators
 Loop 1 Post-Autostart Pre-Autostart



Hard-Limiting [FM]
 or
 Non-Limiting [AM]
 Reception

Correct for
 Bias Distortion

Correct For
 Multi-Path Distortion

Local Loop Operation

Autostart with:
 ◦ Motor Control
 ◦ Mark Hold
 ◦ Antispace

Tuning Oscilloscope
 [Front Panel Controls]
 Meter Indicator Option
 Also Available

Automatic Tx/Rx Station
 Control with Keyboard
 Operated Switch [KOS]

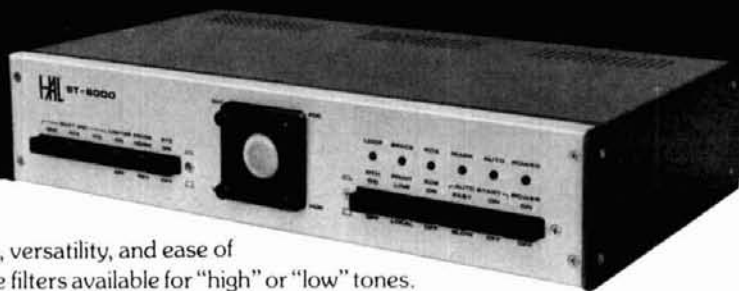

Why not have the best?

The HAL ST-6000 Demodulator offers outstanding performance, versatility, and ease of operation. The Receive Demodulator features multiple-pole active filters available for "high" or "low" tones. These filters are frequency-matched to the transmit tone crystals for true transceive operation. Input bandpass filters, discriminator filters, and post-detection filters are carefully designed and tested for optimum weak-signal recovery. The ST-6000 has an internal loop power supply, 2 loop keyers, RS-232, MIL-188C, and CMOS data I/O, and rear panel connections to data and control circuits for connection to UART and computer devices. Use it with the HAL DS-3000 KSR for the best in RTTY performance.

\$595.00

Write today for HAL's latest RTTY catalog.



HAL COMMUNICATIONS CORP.

Box 365
 Urbana, Illinois 61801
 217-367-7373

For our Overseas customers:
 see HAL equipment at:
 Richter & Co.; Hannover
 I.E.C. Interrelco; Bissone
 Vicom Imports; Auburn, Vic., Australia

receiving preamplifier for OSCAR 8 Mode J

Amateurs who have designed and built vhf and uhf transistor circuits in the past are well aware of the fact that high performance often seems to be more art than science; however, the "art" involved in the design of vhf/uhf amplifiers is rapidly giving way to science with the utilization of S parameters and computer optimization. Using these techniques, an engineer can design a multi-stage vhf or uhf amplifier in a few hours with the aid of a computer and be highly confident of the results. The low-noise 435-MHz preamplifier described in this article is a good example of the combination of the manufacturer's transistor S -parameter data, engineering judgment, and computer optimization.

design approach

Virtually all manufacturers of transistors intended for vhf, uhf, and microwave applications now utilize S parameters to characterize the performance of their high-frequency transistors. This fact alone attests to the usefulness of this parameter set in the design of high-frequency amplifiers.^{1,2} In conjunction with specific noise figure data and bias point considerations, the addition of a computer analysis and optimization program, and sound engineering judgment, you have all the ingredients necessary for a successful design.

This article describes the design of a low-noise 435-MHz receiving preamplifier which is intended for the reception of the downlink communications channel of the OSCAR 8; the preamplifier also provides excellent performance for communications on 432 MHz. Basically, the design approach is developed as outlined below:

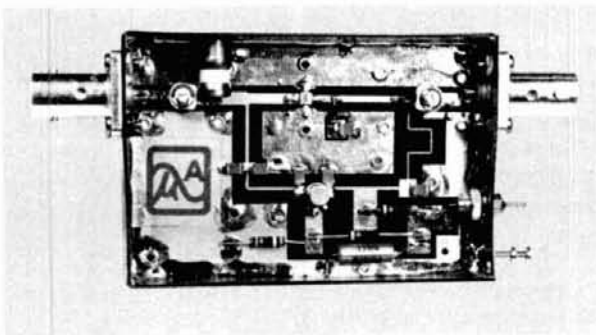

The 435-MHz preamp using the Microwave Associates 42141 transistor. The extra chip capacitor, on the collector lead of the bias transistor, is used to ensure a good ac ground. Note the extensive grounding between the two sides of the printed circuit board.

1. Selection of the appropriate transistor.
2. Determination of the terminal impedances (both input and output) required to obtain the specific performance objectives.
3. Synthesis of the appropriate matching networks to present the desired terminal impedances.
4. Computer optimization of network component values.
5. Stability analysis over a broad band of frequencies.

transistor selection

The main criteria in the selection of a transistor for this application is low noise figure coupled with sufficient gain to minimize the second stage contribution to the system noise figure. The intended device should also be completely specified and characterized in terms of S parameters and noise figure data. In the absence of such data, extensive analysis of the amplifier circuit is impossible unless, of course, the designer is willing to perform the transistor evaluation and characterization himself.

The Microwave Associates 42140 series of uhf transistors is ideally suited for this application. The devices are completely specified and characterized over a broad range of frequencies. At optimum bias, or dc operating point which results in minimum noise figure ($V_{CE} = 8$ volts, $I_C = 5$ mA), the MA42141 has the following characteristics:

$$\begin{aligned}S_{11} &= 0.64 \angle -112^\circ \\S_{21} &= 7.70 \angle 111^\circ \\S_{12} &= 0.046 \angle 41^\circ \\S_{22} &= 0.72 \angle -35^\circ \\ \Gamma_{os} &= 0.32 \angle 38^\circ \\NF_{min} &= 1.80 \text{ dB}\end{aligned}$$

where Γ_{os} is the source reflection coefficient required for minimum noise figure.

transformation networks

From this data, the design task is to synthesize matching networks which present Γ_{os} to the input of

By Mark Pride, K1RX, and Kenneth V. Puglia, Microwave Associates, Inc., Burlington, Massachusetts 01803

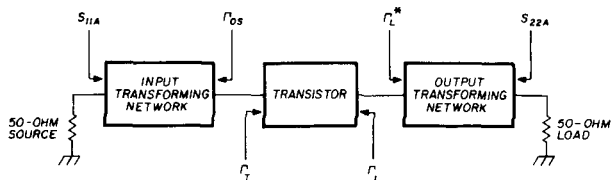

fig. 1. Block diagram of the low-noise preamplifier stage showing the input transformation network, the transistor stage, and the output matching network with applicable reflection coefficients.

the transistor while simultaneously presenting a complex conjugate match at the transistor's output. If low noise figure was not the prime objective, then the design task would be to synthesize input and output networks which would simultaneously provide the complex conjugate impedance to the input and output of the transistor; this would result in maximum gain but not lowest noise figure.

The initial use of the computer is in determining the complex conjugate of the transistor's output impedance. The computer performs this calculation through a program which solves the equation:

$$\Gamma_L = S_{22} + \frac{S_{21}S_{12}\Gamma_{os}}{1 - S_{11}\Gamma_{os}} = 0.35 \angle -54^\circ$$

Also of interest is the input impedance of the transistor which may be calculated from:

$$\Gamma_T = S_{11} + \frac{S_{21}S_{12}\Gamma_L^*}{1 - S_{22}\Gamma_L^*}$$

The asterisk designates the complex conjugate.

The design tasks can be more easily understood by

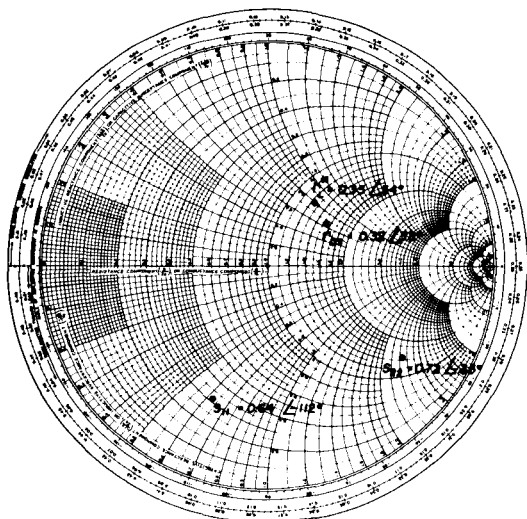

fig. 2. S-parameters for the MA42141 transistor operated at $V_{CE} = 8$ volts, $I_C = 5$ mA.

studying fig. 1 which illustrates, in a block diagram form, a cascade of the input network, the transistor, and the output network. Fig. 2 is a Smith chart plot showing the locations of the various impedance points. The Smith chart will aid in the synthesis of the transforming networks. (Note that a 150-ohm resistor has been added in shunt across the output of the transistor to provide a margin of stability to the amplifier since the initial analysis in determining the complex conjugate of the output impedance indi-

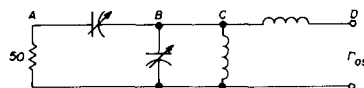
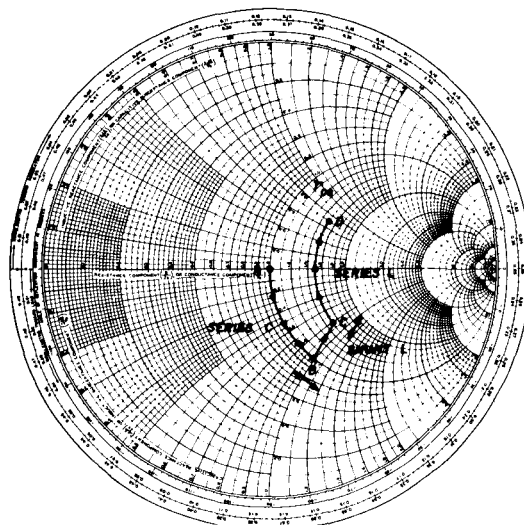

fig. 3. Design of the input impedance transforming network. The Smith chart plot gives preliminary component values which will be optimized with a computer program.

cated that the transistor was potentially unstable when terminated with these impedances.)

The networks required to transform the 50-ohm source and load to the desired impedances may be designed with the Smith chart. Smith charts are an indispensable tool in the design of impedance transforming networks which use reactive circuit elements and transmission lines. References 3 and 4 provide a clear understanding of Smith charts and their applications.

Figs. 3 and 4 may now be used to determine "ball-park" values for the transformation networks. Variable capacitors have been employed at the input to allow for normal transistor manufacturing variations as well as to extract the absolute minimum noise figure available from the transistor. A single variable capacitor at the output allows you to peak the gain and to minimize the output impedance mismatch.

Variable capacitors are recommended for this

application because it's doubtful that either the antenna or the receiver used with the preamplifier will provide the desired 50-ohm impedances; in military and commercial designs where the source and termination impedances are known to be 50 ohms, fixed capacitors are usually installed.

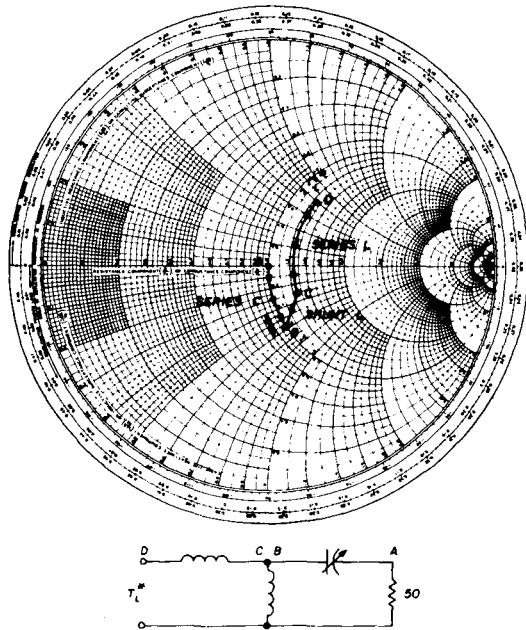

fig. 4. Design of the output matching network with a Smith chart. Component values are optimized with a computer program.

input matching network

At the input of the preamplifier it is necessary to transform the 50-ohm input impedance to the source reflection coefficient required for minimum noise figure (Γ_{os}). This can be accomplished with a T network consisting of a series capacitance, shunt inductance, and series inductance. Beginning at the 50-ohm point at the center of the Smith chart (which has been normalized to 1.0) at point A, the series capacitance moves the impedance to $1.0 - j1.0$ (point B); the shunt inductance rotates this value to $1.5 - j0.9$ (point C); the series inductance transforms this to the source reflection coefficient Γ_{os} at $1.5 + j0.66$.

The required reactance values for each of the components in the matching network can be read directly away from the Smith chart. Note that the series capacitance rotates the input impedance from $1.0 \pm j0$ at the center of the chart to $1.0 - j1.0$ at point B. Therefore, the required capacitive reactance is $-j1.0(50)$ or $-j50$ ohms; at 435 MHz this is represented by 7.3 pF.

To determine the reactance of the shunt inductor it's necessary to first convert to admittance (lower

case letters designate normalized values).

$$\text{Point B } z = 1.0 - j1.0 \quad y = 0.5 + j0.5$$

$$\text{Point C } z = 1.5 - j0.9 \quad y = 0.5 + j0.3$$

The desired transformation requires a normalized susceptance of $-j0.2$; in a 50-ohm system this represents -0.004 Siemens (0.004 mho) or $+250$ ohms. In this circuit this is provided by 37 nH in parallel with 2.2 pF (a 5 pF variable allows adjustment within the limits indicated by the arrows at point C on the Smith chart plot).

The series inductance transforms the impedance of $1.5 - j0.9$ at point C to $1.5 + j0.66$ at Γ_{os} . This requires a normalized reactance of $+j1.56$ or 78 ohms (28.5 nH at 435 MHz).

output matching network

The design procedure for the output matching network is similar to that used for the input network. Working from the 50-ohm load back to the collector of the transistor, the series capacitor transforms the load at A ($1.0 \pm j0$) to point B ($1.0 - j0.58$); the shunt inductor rotates the impedance to $1.23 - j0.35$ at point C. The series inductor then provides the desired reflection coefficient for the load ($\Gamma_L = 0.35 \angle 54^\circ$) at point D ($1.23 + j0.80$).

For the desired transformation the series capacitor must present a reactance of 0.58×50 or 29 ohms; at 435 MHz this is provided by 12.6 pF. To calculate the value of the shunt inductor, the impedance points are converted to admittance:

$$\text{Point B } z = 1.0 - j0.58 \quad y = 0.75 + j0.43$$

$$\text{Point C } z = 1.23 - j0.35 \quad y = 0.75 + j0.21$$

To move from $j0.43$ to $j0.21$ requires a *negative* susceptance of $-j0.22$ or 4.5 milliSiemens. This is equivalent to 223 ohms of inductive reactance of 82 nH at 435 MHz.

The series inductor required to transform $1.23 - j0.35$ at point C to $1.23 + j0.80$ at Γ_L has an inductive reactance of 1.15×50 or 57.5 ohms (21 nH at 435 MHz). A preliminary schematic of the amplifier is shown in fig. 5.

Note that it is necessary only to determine approximate component values for the matching networks because, in this case, a computer program will be

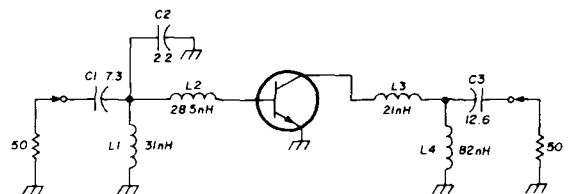

fig. 5. Basic 435-MHz low-noise preamplifier circuit with component values determined with the aid of a Smith chart (figs. 3 and 4).

used to adjust the values for optimum performance. However, values which are close to optimum will result in the usage of less computer time and, hence, lower cost.

Rather than winding inductors which could be lossy and cause stray coupling from unwanted radiation, it is better to use lengths of etched transmission lines for the inductive elements. This can be done providing the line lengths are less than $\lambda/8$ and preferably less than $\lambda/16$. This is more easily seen if you examine the input impedance of a lossless short-circuited transmission line:

$$Z_{in} = +jZ_o \tan \frac{2\pi l}{\lambda}$$

$$= +jZ_o \tan \Theta$$

Where:

- Z_{in} = input impedance to the transmission line
- Z_o = characteristic impedance of the line
- l = length of the transmission line
- λ = wavelength
- Θ = electrical length of the line in degrees

Note that this expression represents a pure reactance which varies almost linearly with the electrical length Θ , provided that Θ is small. Therefore, by varying the characteristic impedance Z_o and the electrical length Θ it's possible to synthesize inductive elements which are very accurate and highly repeatable when printed-circuit techniques are employed.

computer optimization

The next step in the design of the low-noise preamplifier is to select an appropriate computer pro-

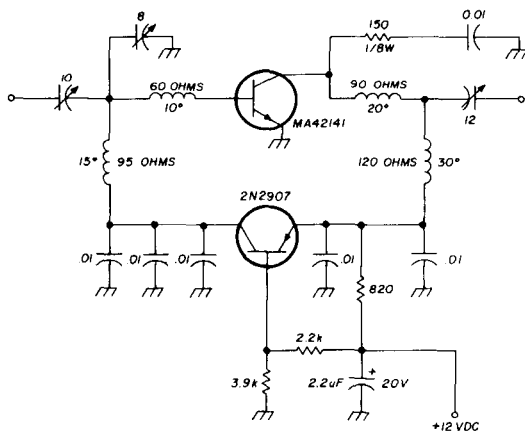

fig. 6. Low-noise 435-MHz preamplifier circuit with computer optimized circuit values. All inductive elements use etched transmission lines of the specified characteristic impedance and electrical length. Fixed values of capacitance are chip capacitors. The 2N2907 is part of the active bias circuit (see fig. 7).

gram to execute the calculations and optimize the component values. The COMPACT* Computer Program is used extensively for this purpose because it has broad capability in terms of network elements and interconnections and is modest in cost when used within certain guidelines.

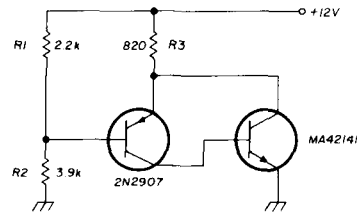

fig. 7. Active bias circuit is used in the low-noise preamplifier to allow direct grounding of the emitter lead. The collector-to-emitter voltage of the MA42141 is determined by voltage divider resistors R1 and R2 (see text).

The information for the computer is written in the form of a data file. Once the data file is written, the computer will vary the network elements and attempt to minimize the error between the desired circuit performance and the actual circuit performance. Specific performance parameters may be weighted so that their attainment carries more importance than other performance parameters. For example, if noise figure is the most important design goal, input impedance match or gain may be sacrificed so that the lowest noise figure may be achieved; the computer will adjust the variable elements in a direction which minimizes noise figure but not necessarily maximizing gain or lowering the input impedance mismatch.

In this case the computer analyzed the circuit and optimized it for operation at one frequency, 435 MHz. Additional or broader optimization could be performed by altering the data file, but this would increase computer time (and cost) because of the larger number of variables. After optimizing the component values, the computer predicted the following preamplifier performance at 435 MHz:

Noise figure 1.81 dB
 Power gain 16 dB
 Output vswr 1.22:1

The noise figure might be somewhat optimistic since no allowance has been made for circuit losses associated with the variable capacitors and high input vswr.

A complete schematic of the optimized preamplifier circuit is shown in fig. 6. The synthesized induc-

*COMPACT is an acronym for Computer Optimization of Microwave Passive and ACTIVE circuits. Additional information is available by writing to Compact Engineering, Inc., 1651 Jolly Court, Los Altos, California, 94022.5.6

table 1. Comparison of computer predicted performance with measured performance.

	computer predicted	measured performance	
		unit 1	unit 2
Noise figure	1.8 dB	1.9 dB	1.9 dB
Gain	16.1 dB	16.0 dB	16.5 dB
Output vswr	1.22:1	1.15:1	1.12:1

tors are specified in terms of their characteristic impedance and electrical length. Table 1 shows a comparison between computer predicted performance and the measured performance of two preamplifiers which were built in the lab.

stability considerations

A broadband computer stability analysis reveals that the preamplifier is unconditionally stable over a frequency band from 400 MHz to 2800 MHz. The importance of the stability analysis cannot be over emphasized because, in many applications, the source and load impedances may take on any value outside the particular frequency band of interest. When a high-gain microwave transistor is used, it is most important to assure that the amplifier does not oscillate as a result of various out-of-band source and load impedances.

dc bias circuit

To realize the predicted performance when using the manufacturer's transistor data, the designer must mount the transistor in a manner which closely approximates the electrical and mechanical environment under which the manufacturer obtained the data. The introduction of parasitic elements in mounting the transistor can lead to large discrepancies between the predicted and measured performance.

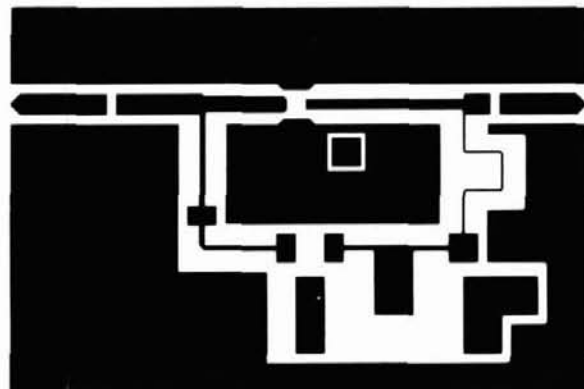

fig. 8. Full-size printed-circuit layout for the low-noise 435-MHz preamplifier. Circuit is etched on 1/16" (1.5 mm) double-clad G-10 fiberglass-epoxy circuit board. Component layout is shown in fig. 9.

The parasitic element which is most sensitive to performance degradation is the emitter lead inductance, which, if not kept to a minimum, will both reduce gain and alter the source impedance required for minimum noise figure. It may also introduce instabilities within the circuit which, under certain conditions, could result in oscillations. For these reasons an active bias circuit has been utilized in this amplifier. The active bias circuit will provide the proper collector-to-emitter voltage and collector current, while allowing direct grounding of the emitter lead to minimize the introduction of any parasitic impedance into the circuit. A schematic of the active bias circuit is shown in fig. 7.

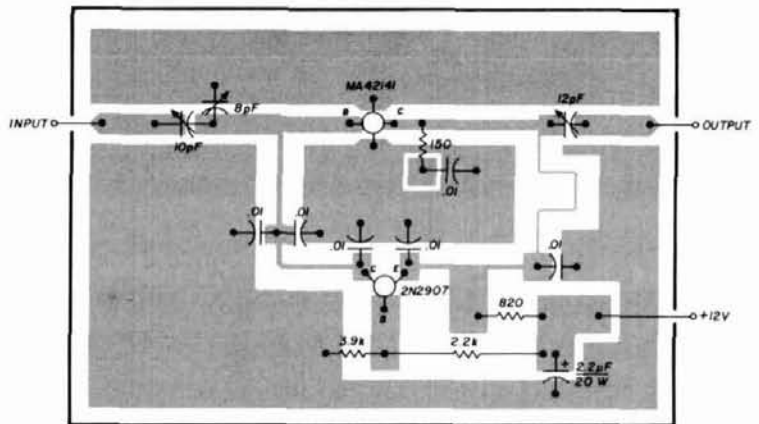

fig. 9. Component layout for the 435-MHz low-noise preamp. For best performance all fixed values of capacitance should be chip capacitors.

The active bias circuit is actually a feedback loop which senses the collector current of the rf transistor and adjusts the base current to hold that collector current fixed. The collector-to-emitter voltage of the rf transistor is held at a fixed potential determined by the voltage divider R1 and R2. The current through resistor R3 becomes the collector current of the rf transistor under the assumption (a good one) that both the 2N2907 and the MA42141 have moderate dc current gain.

references

1. *S-Parameters — Circuit Analysis and Design*, Application Note 95, Hewlett-Packard, Palo Alto, California, 1968.
2. *S-Parameter Design*, Application Note 154, Hewlett-Packard, Palo Alto, California, 1972.
3. Philip H. Smith, *Electronic Applications of the Smith Chart in Waveguide, Circuit, and Component Analysis*, McGraw-Hill, New York, 1969.
4. James R. Fisk, W1HR, "How to Use the Smith Chart," *ham radio*, March, 1978, page 92.
5. *COMPACT Version 4.5*, Compact Engineering, Los Altos, California.
6. *Computer Aided Microwave Circuit Design with COMPACT*, Application Note 1, Compact Engineering, Los Altos, California.
7. *Transistor Designer's Guide*, Microwave Associates, Burlington, Massachusetts, 1978.

ham radio



The HEATHKIT SB-104A

good enough to measure up...to you!

In choosing the SB-104A you join a pretty select fraternity of fellow Amateurs. They're individuals whose imaginations were fired by the looks, feel, and reputation for outstanding performance that, since its inception, has become the trademark of Heath's entire line of famous SB series Amateur equipment.

You've joined a group of people who want state-of-the-art perfection, still insist on building their own to insure handcrafted quality, prefer to do their own maintenance and service, and above all want a rig that's good enough to measure up to their abilities, standards, and the reputations they've built for themselves.

Heath's SB-104A, it's the only choice when you're ready for a transceiver that's good enough to measure up....to you!

**Heath Amateur Radio Gear....
....the quality that measures up!**

FREE Heathkit Catalog

Catalogs also available at the 50 Heathkit Electronic Centers coast-to-coast (units of Schlumberger Products Corp.) where Heathkit products are displayed, sold, and serviced. Retail prices on some products may be slightly higher. See your white pages.



HEATH
Schlumberger

Heath Company,
Dept. 122-420
Benton Harbor,
Mi. 49022

Gentlemen, please send me my free Heathkit Catalog
I am not on your mailing list.

AM-372

Name _____

Address _____

City _____ State _____

Price is mail order, F.O.B. Benton Harbor, Mi.
Prices and specifications subject to change without notice. Zip _____

single IC *Touch-Tone* decoder

A new integrated circuit
and high performance
active filter
are combined into
an extremely reliable
Touch-Tone decoder

A majority of repeater stations today are using *Touch-Tone** circuitry for such functions as autopatch, control, and signaling; individual home and mobile stations make use of encoders and decoders for selective calling and radio control. Dozens of designs have been published for *Touch-Tone* decoders during the last several years. Unfortunately, virtually none of these circuits is reliable.

The use of the 567 phase-lock loop IC, upon which nearly all designs are based, is not recommended unless limited performance is acceptable. Elaborate support circuitry is required, and even then you may not achieve the desired noise immunity or stability. The tradeoffs are many: response time vs bandwidth, noise immunity vs bandwidth, and economy vs reliability.

The 567 PLL chip has several important limitations which must be dealt with regardless of whether you are using the 567, or are a circuit designer developing a totally new decoder IC.

signal consideration

Amplitude Variations. Twisted-pair telephone wires are transmission lines, just as coaxial cables are. Shunt capacitance and series inductance serve to increase attenuation as frequency goes up. This disparity means that high group *Touch-Tone* signals are usually attenuated more than the low group. This variation in amplitude is referred to as "twist." Tone pads attempt to compensate for this by having a stronger output from the high group than the low

**Touch-Tone* is the registered trademark of the American Telephone and Telegraph Company.

By Larry Nickel, W3QG, 216 Highmeadow Road, Reisterstown, Maryland 21136

group. In addition, when decoding tones from an fm receiver, signal strength and deviation are two more variables. An effective decoding scheme must incorporate an audio ALC system. If the decoder circuitry is sensitive to twist, then separate ALC control could be necessary for the high and low groups.

Bounce And Noise. A *Touch-Tone* source may not present a clean, stable leading edge. Secondly, noise, music, or speech may momentarily produce coincident tones at the proper frequencies, which could be recognized as a legitimate *Touch-Tone* pair. What is required is a delay, of perhaps 40 milliseconds, before a valid tone pair is acknowledged. Then the decoder output must turn on and stay on until the signal disappears, with no bounce. It has been my experience that achieving good noise rejection, fast response without false tripping, and freedom from bounce is not practical with PLL techniques.

Frequency Stability. Tone generation schemes which depend on RC time constants for frequency stability are not reliable, especially at temperature extremes. This is why the Motorola MC14410 and Mostek MK5087 crystal-controlled encoder chips were developed. The same is true of decoding circuitry. Crystal control is a must!

new generation integrated circuits

Within the last two years, several manufacturers have introduced some very sophisticated tone-decoder ICs. The first entry was Rockwell International's Collins CRC8030 dual tone multi-frequency (DTMF — another name for tone control) receiver. It is an MOS decoder chip in a 28-pin dual-in-line package which uses a standard 3.579545 MHz TV

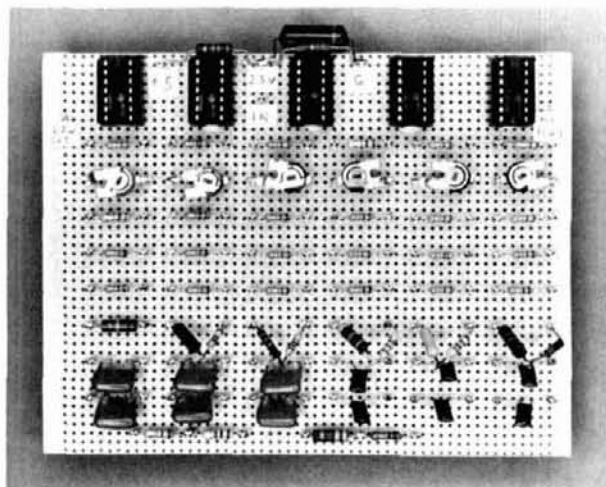

Layout of the tone separation filter.

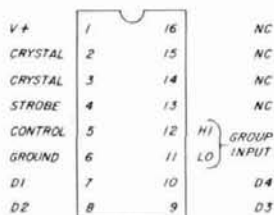

fig. 1. Pinout diagram for the Mostek 5102 *Touch-Tone* decoder.

color-burst crystal for its reference. This ceramic IC was originally priced at \$49 in unit quantities, but a plastic case (CRC8030-3-3) now sells for \$42. An ALC system, a filter (which separates high and low group tones), and two voltage comparators are required to complete the decoder. General Instrument also produces a decoder selection designated the AY59800 series. One or more of these chips use a 1 MHz crystal and require dual power supplies.

table 1. Data output from the MK5102 decoder.

digit	4-bit binary				dual 2-bit row column			
	D1	D2	D3	D4	D1	D2	D3	D4
1	0	0	0	1	0	1	0	1
2	0	0	1	0	0	1	1	0
3	0	0	1	1	0	1	1	1
4	0	1	0	0	1	0	0	1
5	0	1	0	1	1	0	1	0
6	0	1	1	0	1	0	1	1
7	0	1	1	1	1	1	0	1
8	1	0	0	0	1	1	1	0
9	1	0	0	1	1	1	1	1
0	1	0	1	0	0	0	1	0
*	1	0	1	1	0	0	0	1
#	1	1	0	0	0	0	1	1
A	1	1	0	1	0	1	0	0
B	1	1	1	0	1	0	0	0
C	1	1	1	1	1	1	0	0
D	0	0	0	0	0	0	0	0

The newest entry into the tone-decoder field is the Mostek MK5102. It's a CMOS chip in a 16-pin package, with a typical power dissipation of only 25 mW, at 5 V dc. Available in either a ceramic (MK5102P-5) or plastic case (MK5102N-5), unit quantity prices start at \$34.50.* Even though this is a large sum of money to pay for an IC, at this time it is the *only* way to build a complete, top-quality decoder without spending more than \$60.

A pinout diagram for the MK5102 is shown in fig. 1. Compared to the 28-pin CR8030, this is sheer simplicity. The 5 V dc and ground connections, pins 1 and 6 respectively, are self-explanatory. An inexpensive 3.579545-MHz TV-color burst crystal is connected between pins 2 and 3. Pin 5 is used to control the output format of pins 7 through 10 (D1 through D4). This tri-state input line selects a four-bit binary code

*Quality Components, 13628 Neutron Road, Dallas, Texas 75240.

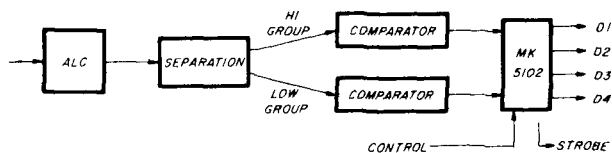

fig. 2. Block diagram of a complete tone decoding system using the new single IC tone decoder.

(input high), a dual two-bit row/column code (input floating), or high-impedance output (input low) for use with bus-structured circuitry.

Pins 7 through 10 are the data out lines. The outputs are CMOS loads when enabled, and open circuited (high impedance) when disabled by the control pin. The output data formats are shown in table 1. The two output codes allow the user to obtain either 1-of-16 or 2-of-8 output data by only using a single additional package.

Pin 4, the strobe output, goes high after 40 mS of a valid tone pair, and remains high for a minimum of 10 mS after the input ceases. The output information is valid when the strobe signal goes high and will remain unchanged until the next DTMF digit is detected.

The low- and high-group tones are filtered, separated, and applied to pins 11 and 12, respectively. The MK5102 can detect capacitively-coupled, square-wave signals as small as 1.2 volts pk-pk. The tones are detected, after band splitting, using the digital-counter method. The zero crossings of the incoming tones are counted over a longer period. When a minimum of 40 milliseconds of a valid signal is detected, the proper data is latched into the outputs and the output strobe goes high. When a valid

digit is no longer detected, the strobe will return low and the data will remain latched into the outputs. The minimum interdigit time is 35 milliseconds.

A block diagram of a complete *Touch-Tone* decoding system using the MK5102 is shown in fig. 2. The ALC reduces any amplitude variations from the signal source.

The low-group tones, the rows on your *Touch-Tone* pad, and the high group tones, the columns, are separated in the tone-separation filter. Its outputs are two sine waves which are squared up in comparators and applied to the MK5102.

active filter

Design Considerations. An active filter for a 1-kHz frequency range is generally of low cost, small, has gain, high-input impedance, low-output impedance, and is easy to design. My intention here is not to make the reader a filter expert but to give a little of the philosophy behind the design of this one. My criteria were:

1. It must be inexpensive.
2. It must use readily available components.
3. It must be easily constructed.
4. It must provide adequate out-of-band rejection.

For the bandwidth and Q required, a stagger-tuned circuit is necessary. After examining sample response curves for 2-section filters, I felt that at least 3-sections would be required to achieve adequate out-of-band rejection. One section is tuned to the center frequency, another is tuned to s (the "staggering value") times the center frequency, and

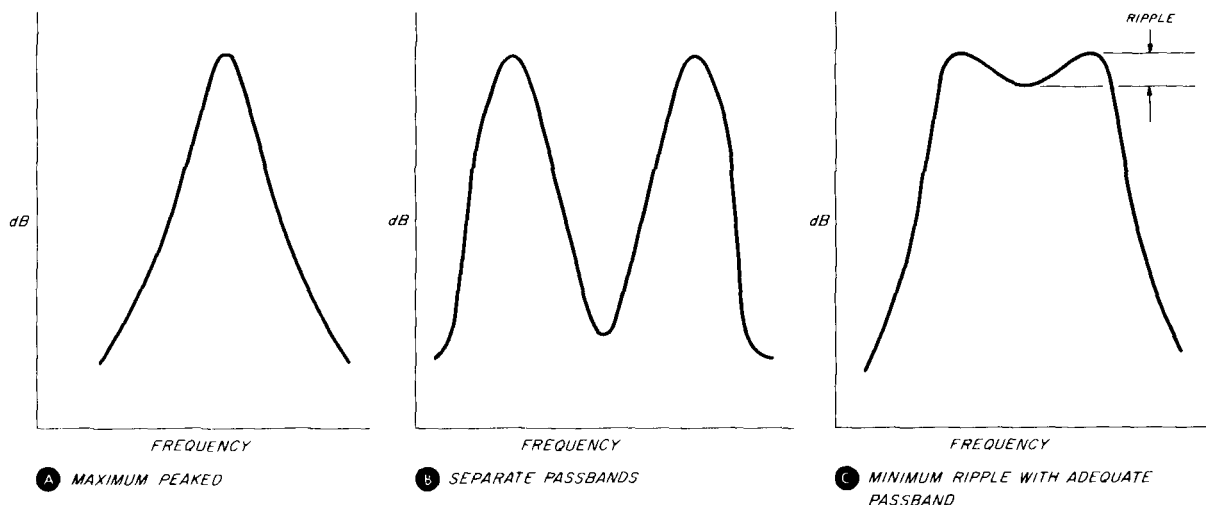

fig. 3. Passband response as a result of varying s in equation 1. A shows a single-peaked response when $s = 1$. For large values of s , B shows the dual-peaked response. In C, a response is obtained that has a minimum passband ripple, yet adequate bandwidth ($s = 1.16$).

the third $1/s$ times the center frequency. For $s=1$, the response has one peak and a very-narrow bandwidth (fig. 3A). For a large value of s , 1.5 for instance, there are two separate distinct passbands (fig. 3B). By selecting the best value of s for two- or three-section filters, a suitable bandwidth with minimum ripple can be achieved, as shown in fig. 3C. Each of the three sections is designed for a particular Q . Usually, it is best for the center section to have a lower Q than the outside sections which have identical higher Q s. This makes for a flatter passband and a steeper slope beyond the passband (if the Q is too high the ripple in the passband will be excessive).

The transfer function for a three-section filter is:

$$\frac{E_{out}}{E_{in}} = 20 \log_{10} (A \cdot B \cdot C) \quad \text{eq. 1}$$

where

$$A = \sqrt{1 + Q^2 \left(\frac{f^2 s^2 - 1}{f s} \right)^2}$$

$$B = \sqrt{1 + Q^2 \left(\frac{f^2 / s^2 - 1}{f / s} \right)^2}$$

$$C = \sqrt{1 + \left(\frac{Q}{2} \right)^2 \left(\frac{f^2 - 1}{f} \right)^2}$$

s = staggering value

f = normalized center frequency, with two outside sections of Q selectivity and one center section of $Q/2$ selectivity.

Various values of s and Q were calculated and plotted. Using $s=1.16$ and $Q=10$ and 20 for the center and outside sections, produced a passband ripple of 3 dB and 32 dB of rejection for the other tone group. With the s and Q values determined, it only remained to select a suitable circuit.

Many designs, using 1, 2, 3, and 4 amplifiers per section, have been published, but the disadvantage of the 1- and 2-op amp versions is that they are not generally suitable for high Q applications, especially with inexpensive ICs which have low gain-bandwidth products. Since low-cost quad op amps are available, and in many pin compatible packages, a 3- or 4-op amp design is preferable; any circuit configuration would be acceptable, especially if one per cent tolerance resistor and capacitors are used, but I did not wish to use precision components, and therefore, expended the additional labor to ensure that standard parts can be used.

Filter Selection. The BIQUAD filter section (see fig. 4) was chosen because the center frequency and Q can easily be adjusted by trimming just one resistor for each function. The principle of operation of the

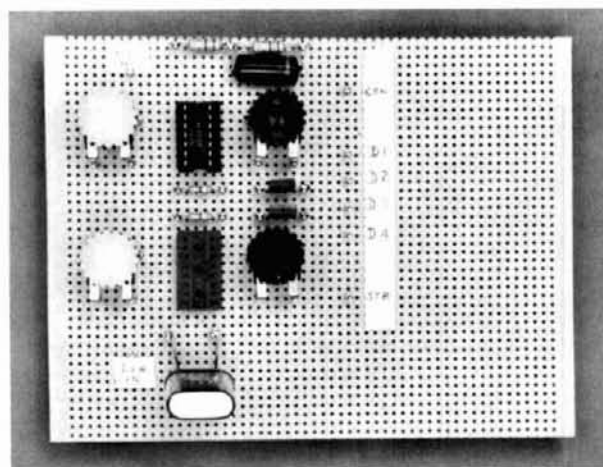

The partially completed decoder board.

BIQUAD is as follows. Since the integral of a sine wave is a cosine wave, or a 90-degree phase shift, U1 is an integrator, giving a 90-degree shift. U2 is an inverter yielding 180-degree shift, for a subtotal of 270 degrees. U3 is another integrator giving an additional 90 degrees, for a grand total of 360 degrees. Positive feedback may then be provided from input to output.

Without the Q setting resistor, the gain and Q of the BIQUAD would be excessively high, causing the circuit to oscillate at the frequency where the phase shift is 360 degrees (the integrator and inverter do not have exactly 90 degrees and 180 degrees shift respectively at more than one frequency). This resistor introduces enough loss so that the Q is controlled and the BIQUAD does not oscillate. The actual frequency response curve for the complete filter is shown in fig. 5 and its schematic is presented in fig. 6.

Filter Operation. The tonal input is simultaneously applied to both sides of the filter, passing through the 686 Hz, 809 Hz, and 955 Hz sections of the low-group filter as well as the 1191 Hz, 1404 Hz, and 1657 Hz sections of the high-group filter. Resistive dividers R19/R20 and R41/R42 reduce the outputs of the 686 Hz and 1191 Hz sections so that these sections may be driven farther toward cutoff and saturation without overloading the following stages. Since a single 12-volt supply is used, R39 and R40 divide 12 volts down to 6 volts, establishing the dc bias so that the output may swing equally about 6 V dc. C13 ensures that the 6 V dc bias line is at ac ground.

filter construction

My filter was built using wire-wrap techniques. I used standard, wire-wrap IC sockets with a phenolic

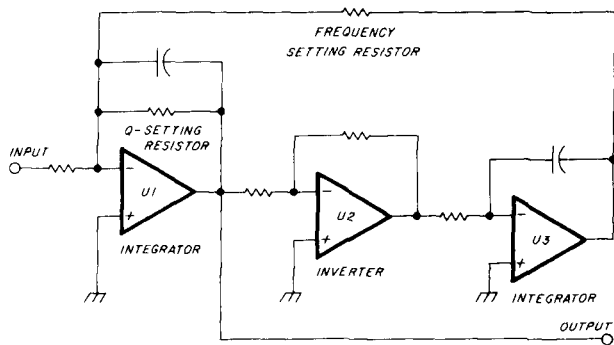

fig. 4. Diagram of the basic BIQUAD active filter. The two integrators produce a 90-degree phase shift and the inverter provides 180 degrees of shift. With proper feedback, this filter will pass a single frequency.

board and Vector wire-wrap terminals to mount the resistors and capacitors. This method has one very attractive advantage (though it is slightly more expensive), it's very fast, especially compared to point-to-point soldered connections.

Drop the Vector pins into place, seating them by pulling from the bottom of the board. Epoxy the sockets into position. The board can be wired using an inexpensive, hand wire-wrap tool. The use of pre-cut and stripped no. AWG 30 (0.25mm) wire further speeds assembly. Use an ohmmeter to check *all* wiring for errors. This is extremely important since it will prevent damaging components and could save considerable time later.

Temporarily install the final 12 resistors using the nominal values shown in the schematic. Miniature potentiometers set to these values are highly recommended. Only six are needed since the low and high group filters can be tuned separately. These pots can be removed later and precision resistors installed.

Make your own precision resistors by wiring two or more resistors in series, or by using the W3QG trimming technique. For instance, to make a precision 11.5k-ohm resistor, file a V notch in a 1/2-watt, carbon, 10k-ohm resistor until the exact value is attained. A small grinding wheel on a Dremel tool is even better; use a light-stroking motion. And finally, seal the exposed carbon with a dab of epoxy.

tuning and alignment

For checkout, you will need a sine-wave audio source and an oscilloscope. It would be helpful if the sine-wave source does not change in amplitude as it is tuned from one frequency to another, but if necessary its output can be readjusted with the scope.

You should now install the ICs and apply power. Set the generator for approximately 50 mV peak-to-peak. Beware, a larger value may reduce the *Q* and/or drive the op amps into nonlinearity. Be sure

the generator does not cause a dc-bias problem with the filter; you may want to include a 0.01 μ F capacitor in series with the filter input.

Tune the generator from approximately 600 Hz to 1200 Hz with the scope connected to the low group output. Notice where the three filter sections are peaking. Don't expect the peaks to be the same amplitude since the *Q* has not been tuned yet. If you have chosen to use pots, tune the center frequency of each section to the correct value, using R6, R12, and R18.

If you are using individual resistors, divide the actual center frequency of each section by the desired frequency for that section. Square this fraction and multiply it times the existing resistor value. This will give you the approximate value for a resistor which will put you very close to the desired frequency. Set the center frequency for the three high group sections in a similar manner by tuning the generator from approximately 1000 Hz to 2000 Hz.

To tune the *Q*, each BIQUAD could be driven and monitored separately and adjusted to the desired *Q*. An easier method is as follows. The *Q* of the first low group section is 20; the frequency is 686 Hz; the bandwidth is 686/20 or 34 Hz. Hook the oscilloscope to U3 pin 7. Adjust the generator to the center frequency and note the amplitude. Find the two frequencies where the output is 3 dB (0.707 times) less than at the center. Is the bandwidth more or less than 34 Hz? Adjust R2 upward to increase *Q* or down to decrease *Q*. Once this value equals 20, connect the scope to the output of the low group filter.

Set the generator for the center frequency of the 686 Hz section. If, for instance, the output is 500 mV peak-to-peak, tune the generator to the center of the 809-Hz section and adjust R8 for 500 mV, then tune the generator to the center of the 955-Hz section and adjust R14 for 500 mV.

The high-group filter may now be tuned in a similar manner at its respective frequencies, first adjusting the 1191-Hz section, via R22 for a *Q* of 20 and a 60-Hz bandwidth with your scope on U3 pin 8. Then,

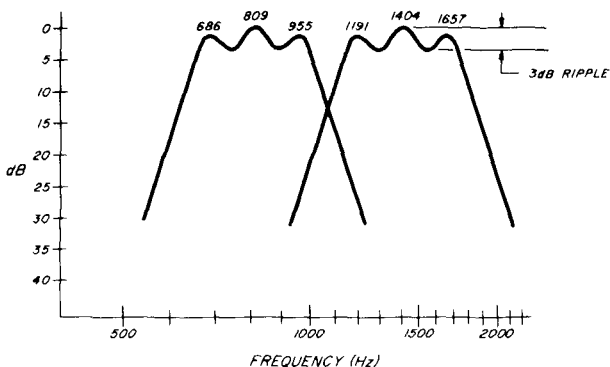

fig. 5. Filter response for the high and low tone separation filter.

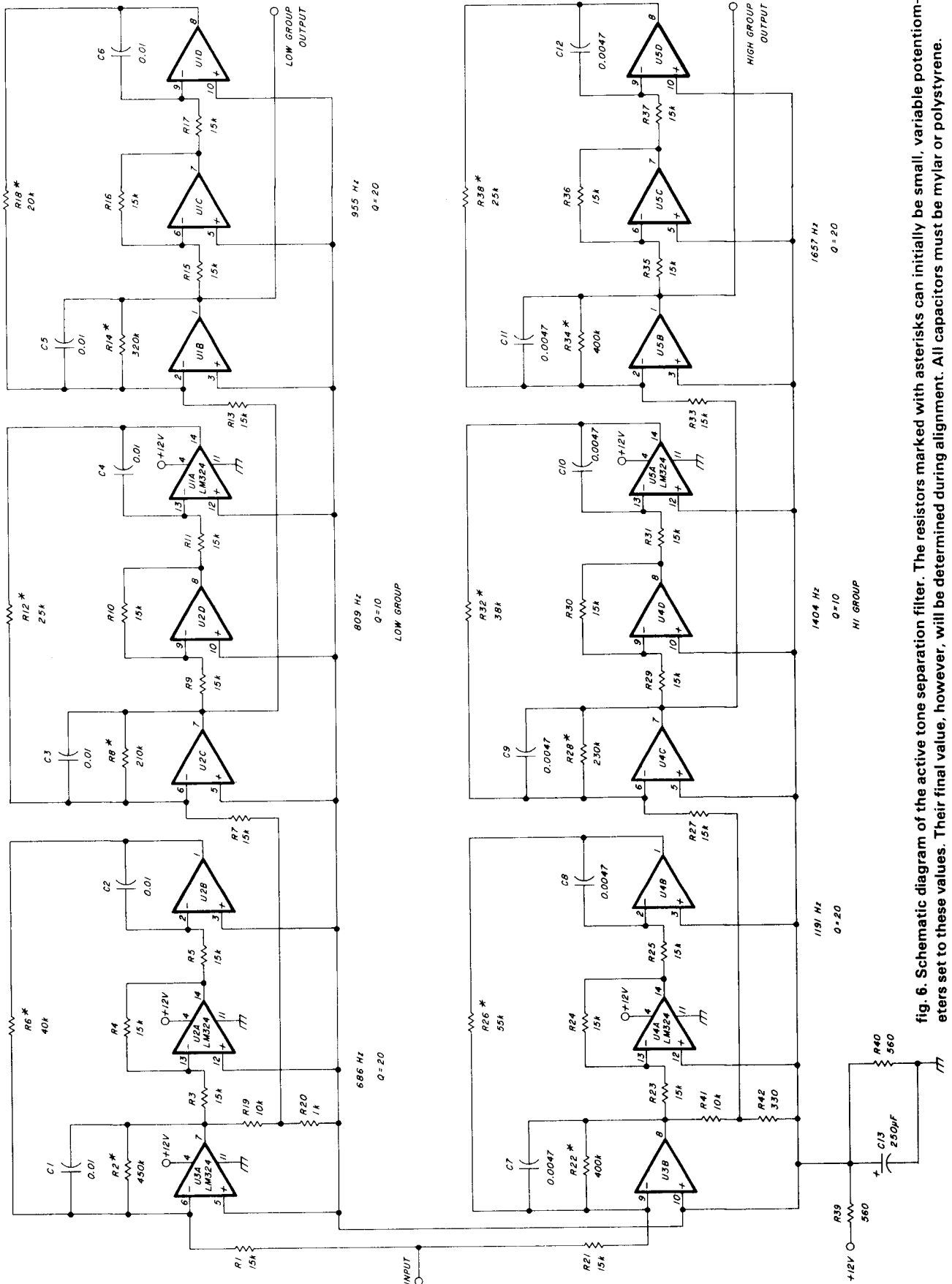

fig. 6. Schematic diagram of the active tone separation filter. The resistors marked with asterisks can initially be small, variable potentiometers set to these values. Their final value, however, will be determined during alignment. All capacitors must be mylar or polystyrene.

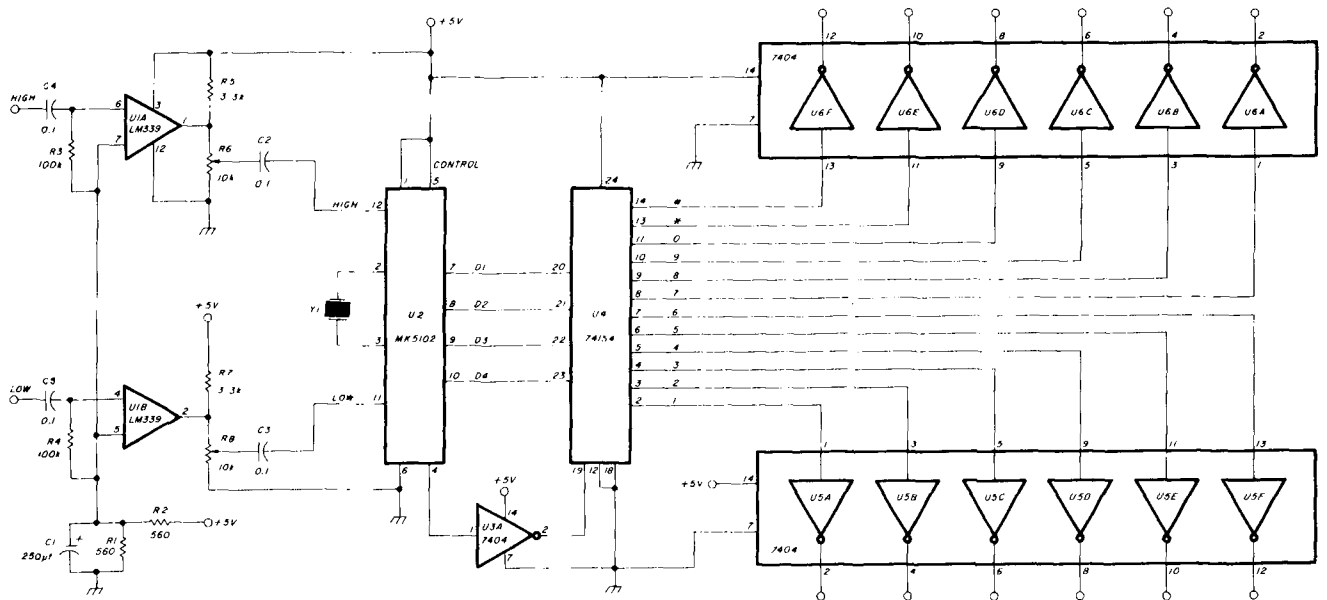

fig. 7. Schematic diagram of the decoder section. The data from the 74154 is active low, and can be inverted (by U5 and U6), depending upon the needs of your system.

with your scope on pin 1 of U5, adjust R28 and R34 at 1404 Hz and 1657 Hz respectively as you did for the low-group sections. Finally, check to ensure that 1209 Hz is really 30 dB down from 941 Hz in the low-group filter, and vice versa.

A voltmeter may be substituted for an oscilloscope for every filter test, but it will not allow you to see nonlinearities, oscillations, and hum. Also, a *Touch-Tone* pad can be used as a frequency standard to calibrate the generator by setting up a Lissajous pattern. On most pads, pressing two row or column buttons will produce only the sine wave for that row or column.

If your filter oscillates, the problem may be:

1. The *Q* of one or more stages is too high.
2. The power supply is not adequately bypassed.
3. The ground circuit is not adequate.
4. Circuit layout causes unwanted feedback.

The filters I have constructed have not had these problems. Should you decide to use a substitute op amp be aware that if it has poor power supply rejection or insufficient phase margin, it could cause oscillation.

comparator and decoder circuitry

Fig. 7 is the schematic for the comparator and decoder. The two sections of the comparator U1 are used to square up the filter outputs. The resistive dividers on the output of the comparators allow adjustment of the drive to the MK5102, although this

does not seem critical; you may choose to replace the pots with fixed dividers.

In this circuit, the decoder's data control pin is tied to 5 V dc to constantly enable the proper format. A 74154 separates the twelve subsequent commands. The 74154 outputs are active low, so if you require active high signals include hex inverters U5 and U6. If the digit 1 is received, then pin 2 of the 74154 will stay low just as long as the 1 is being received.

The filter, decoder, and ALC circuitry has been in operation for many hours. It's presently connected to the output of a 2-meter fm receiver tuned to a noisy, busy, repeater channel, and is used every day for selective call and remote control. The circuit does not trigger on false signals. In fact, it has proven to be stable and reliable, sufficiently so that it has permanently replaced an earlier sophisticated 567 PLL decoder system which was in use here for over a year and a half.

Incidentally, there is a minor limitation of which you should be aware. Because of the ALC used with this system, a signal with somewhat low deviation will not be a problem. However, a signal with excessive deviation will be wider than your receiver's pass-band and will not be decoded. This is not a fault of the decoder, but must be corrected at the transmitter.

Soon the MK5102, with its tri-state outputs, will be connected to a MOS-Technology 6502 microprocessor system so that more complex functions may be performed. I welcome and solicit any and all comments and improvements to this *Touch-Tone* decoder.

ham radio

antenna guys and structural solutions

Advice on choosing
guying materials
and installing them
for safety
and long life

Amateurs with free-standing antenna towers are fortunate indeed: no need to worry about guy wires, anchors, and supports. But if your antenna tower must be guyed, how do you ensure that your guying system will withstand the forces of high winds? What about your soil conditions? Can your soil hold guy anchors?

This article gives some guidelines on how to handle the problem of guying antenna towers erected on various types of soil (from hard rock through loose sand and gravel). Also included are some tips on guying materials and how to use them. The author has had some 30 years of experience in the engineering and construction of antenna systems in locations where wind velocity often exceeds 185 km/hr (100 knots).

guy-anchor placement

Starting at ground level and going up, the location of each guy anchor is our first consideration. Ideally, guy anchors should be placed the same distance from the tower or mast base as the guy attachment to the structure, a 1:1 ratio. A minimum of three guys, spaced 120 degrees apart are considered while four guys spaced 90 degrees apart is most desirable. When real estate is not available to maintain the de-

sired 1:1 ratio, consideration should be given to an acceptable ratio of 6:4.

anchors

Table 1 shows how we may expect our anchors to accept the strain when installed in various soils. Considering the load that an average guy will put on the

table 1. Classification of soils. The soil classification is used for determining the type of holding anchor guy wires (Courtesy Graybar Electric).

soil class	soil description
1	hard rock, solid
2	shale or sandstone, solid or layered
3	hard, dry, hardpan
4	crumbly, damp
5	firm, moist
6	plastic, wet
7	loose dry sand, gravel

anchor and rod, the stamped 152-mm (6-inch) anchor with a 13 mm (1/2 inch) by 1.5-meter (5 foot) rod will perform satisfactorily in most locations (**fig. 1**).

In my case anchor holes were drilled with a power-driven post-hole digger leased from a local equipment rental agency. Angle the anchor hole so that guy tension is in a straight line with the anchor rod. The holding ability of this type of construction is shown in **table 2**. Before placing the anchor and rod, dress the rod threads to prevent the nut from backing off.

These units will survive for many years if the soil composition is not corrosive. A test with litmus

table 2. Holding power of a 152 mm (6 inch) cone anchor in several soil types (courtesy Graybar Electric).

soil classification (table 1)	3	4	5
pounds (kg) ultimate	10,000(4540)	8,000(3632)	6,000(2724)

By Marchal H. Caldwell, Sr., W6RTK, 4620 Greenholme Drive, No. 4, Sacramento, California 95842

paper will reveal the presence of any contaminants. Coat the rod and anchor with thinned roofing mastic before back filling.

guy wire material

Consider the actual guy wire. There are probably more different guy wire types than vacuum tubes, and most will survive for a long time. Since an antenna and its supporting structure represent a considerable investment, the proper selection and use of

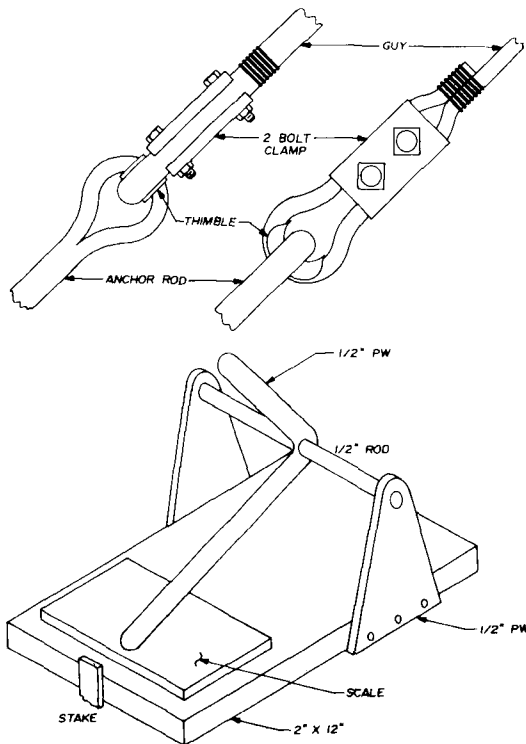

fig. 1. Mechanical details for securing anchor hardware on guy wires. Lower sketch shows a method for adjusting guy-wire tension. An ideal ratio of 1:1 is assumed for the distance of guy-wire attachment to structure (that is, guy locations should be the same distance from tower base as the guy attachment to the structure). A compromise ratio of 6:4 is acceptable.

guying materials is a must. **Table 3** lists some of the available solid and stranded guy wire.

attaching the guys

Guy-wire attachment to the anchor rod eye is usually by a clevis-and-eye turnbuckle, with the clevis end attached to the rod and the guy strand attached to the eye by wire rope clamps. At least two clamps must be used spaced six times the diameter of the wire. The wire dead-end should be served around the wire adjacent to the outer clamp. Turn-

fig. 2. Method for securing terminal hardware to a guy. Note how guy wire should be served (7 turns, 7 times).

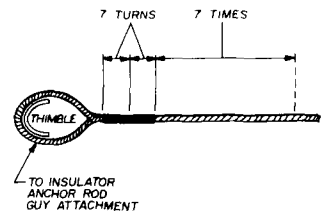

buckles should be safety-wired. A thimble should be used under the wire and inside the eye (**fig. 2**).

Towers and masts are sometimes provided with a guy attachment bracket. Terminate the guy wire in the same manner as used at the turnbuckle (**fig. 3**). When no guy bracket is provided, wrap the guy around the tower leg above a cross brace.

Proper guy tension has always presented a problem. The only sure and safe method is to use a strand dynamometer, which is expensive and normally not available. However, most amateurs use the eyeballing method — keeping too much tension out and not too much sag.

strain insulators

Some antenna structures will require the guy wires to be broken with strain insulators while others won't need this treatment. **Fig. 4** shows how to connect strain insulators in the guy wires. Note the recommended method of serving the loose ends of the wires, which is extremely important. At amateur frequencies, the most desirable maximum distance between guy-wire insulators is 3 meters (10 feet). Your

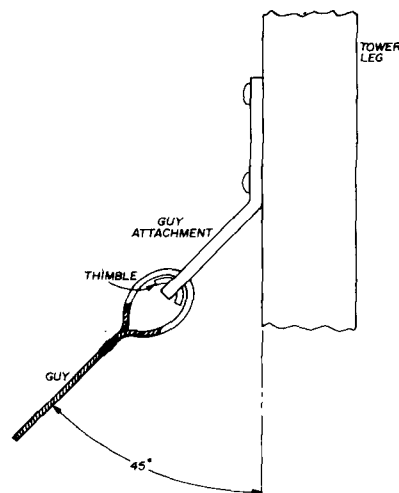

fig. 3. Connecting terminal hardware to a mast or tower, showing recommended geometry for guy placement. An angle of 45 degrees is ideal, but compromises are acceptable depending on your local wind conditions and available real estate.

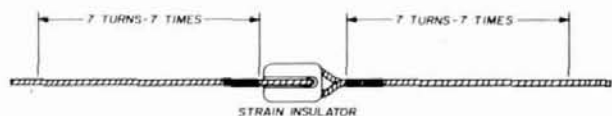

fig. 4. How to connect strain insulators to your guys. Serving the loose ends of the guys follows the rule: 7 turns, 7 times.

pocketbook will be the deciding factor since the insulators and guy wire clamps could cost about \$5 at each point.

- Reasonably corrosion-proof materials should be used in your antenna construction. Hot-galvanized materials are among the best. An excellent source of supplies is your local electrical contractor. Exploration of surplus and salvage agencies often produces items at a considerable saving — but again, don't compromise on quality!

Personal safety during construction is a most important consideration, which must be practiced and observed. Have an adequate supply of strong hands and backs available when erecting any type of supporting structure. Ground-crew members should be equipped with hard hats, safety shoes, work gloves, and a knowledge of your construction plans. Climbers should be similarly equipped and have a good safety-belt.

If you're considering constant experimental work at the top of your structure, fall-safe units are available, which will prevent a disastrous fall. (This stuff is expensive, but so is a hospital bed!)

table 3. Guy-wire strength in terms of size, breaking strength, and maximum load (courtesy Graybar Electric).

	size, mm(AWG)	breaking strength, kg (lb)	maximum load, kg (lb)
galvanized telephone & telegraph	2.6 (10)	293 (645)	136 (300)
	2.1 (12)	193 (425)	91 (200)
	1.6 (14)	112 (247)	52 (115)
	diameter, mm (in)	breaking strength, kg (lb)	maximum load, kg (lb)
seven wires twisted into 1 strand (common grade)	5.0 (3/16)	522 (1150)	250 (550)
	6.5 (1/4)	863 (1900)	409 (900)
	8.0 (5/16)	660 (3200)	681 (1500)
seven wires twisted into 1 strand (utility grade)	5.0 (3/16)	999 (2200)	477 (1050)
	6.5 (1/4)	1816 (4000)	908 (2000)
— Western Union, AT&T	8.0 (5/16)	2724 (6000)	1362 (3000)

Finally, but by no means of less importance, remember that erecting a supporting structure near high-voltage power lines could cause you to miss out on the Quarter Century Wireless Club.

ham radio

Just The Best.

Larsen Kūlrod Antennas



NMO 150 · 220 · 440 · K \$35.45
ANTENNA ONLY \$25.55

NLA 150 · 220 · 440 · K \$35.45
ANTENNA ONLY \$25.55

LM 150 · 220 · 440 · K \$35.45
ANTENNA ONLY \$25.55

JM 150 · 220 · 440 · K \$35.45
ANTENNA ONLY \$25.55

ORDER BY MOUNT, FREQ., ADD K
FOR COMPLETE ANTENNA.

CW ELECTRONIC SALES CO.
1401 BLAKE ST. DENVER, CO. 80202
(303)-893-5525

vfo design

using characteristic curves

Graphical aid to help you choose vfo component values on the basis of working-frequency range and scale linearization

This article will help you design a vfo using what I call the "universal characteristics" of the Colpitts oscillator. The hard work has already been done with the aid of a computer. The result is a family of parametric curves that allow you to choose frequency determining values of critical components precisely and without guesswork.

background

Several months ago I started the project with an ssb transceiver using ICs, following the new and well-known concept of concentrating all common circuits that don't depend on reception-transmission frequency in a single printed circuit. An external vfo and a tuned amplifier in the input-output circuit

defined the transceiver operating frequency. Several IC manufacturers have developed exclusive ICs for the common parts of the transceiver mentioned above by *standardization and by reducing the number of discrete components.*

the external vfo

The first problem I met was designing the external vfo. I needed a vfo in the 5 to 5.5-MHz frequency range with good stability and linearity. Because of the chosen frequency and the oscillator characteristics, I chose the Colpitts oscillator. I first tried to find articles that already described vfos working in my desired frequency range. I found a couple of circuits, and despite the different component values shown, I started construction following the scheme in **fig. 1**. First of all I used a capacitor, $C_v = 80 \text{ pF}$ with an inductance of approximately $L = 5 \text{ } \mu\text{H}$, using different values for C1 and C2. I immediately realized the dif-

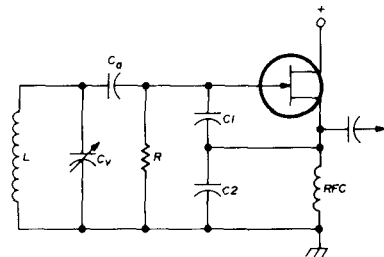

fig. 1. Typical vfo Colpitts oscillator circuit used in the text example. Components L , C_v , C_a define the oscillation frequency, for which parametric curves have been derived and are shown in fig. 3.

By Maurizio Gramigni, I2BVZ, 1621 16th Avenue NW, Rochester, Minnesota 55901

facilities ahead; in fact, when turning C_v 180 degrees, the frequency range was around 1.6 MHz, which was not the desired range. After this failure I decided to face the problem from a technical point of view, starting from these assumptions:

1. Determine frequency stability vs temperature variation.
2. Calculate circuit-component values on the basis of the chosen working frequency range and scale linearization.*

Regarding point 1, the use of an fet is highly recommended compared with bipolar transistors or vacuum tubes. The advantages are listed below:

1. An fet, with its high input impedance, can amplify signals with very low current level. As a result the power dissipation will be less than with bipolar transistors and vacuum tubes.
2. As a consequence of point 1 above, the heat dissipated and transferred to the oscillator components is lower, resulting in better thermal stability.
3. Since the power used is very low and the fet mass is very small and compact, the thermal equilibrium will be reached in a very short time — 30-40 seconds.

Using components such as silver mica capacitors helped to provide an oscillator with a very good frequency stability.

Calculating component values as a function of frequency range and scale linearization is the subject of this article. Fig. 1 shows our vfo circuit. Let's say, first of all, that L , C_v , C_a define oscillation frequency,

fig. 2. At the resonant frequency the oscillator impedance will equal zero. The network L , C_v , C_a formed the basis of the FORTRAN program, which resulted in the universal characteristic curves for determining vfo values as shown in fig. 3.

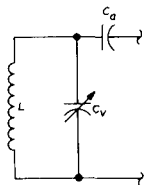

while $C1$ and $C2$ are the positive feedback network, which provides self starting and maintains oscillation. Distortion due to the nonlinear elements is limited by the proper choice of resistor R .

*Scale linearization means that any variation of C_v capacitance, ΔC_v , always corresponds to the same frequency variation, Δf , in the entire oscillator range; that is, the linearity ratio, $\Delta f/\Delta C_v$, remains constant in the chosen range.

Generally it's easy to design an oscillator working at one predetermined frequency. In fact, this occurs when the capacitive reactance of the oscillator circuit equals its inductive reactance. If a variable frequency oscillator is needed, however, a different approach to the problem is required. In this case, once the frequency range is chosen we need to know L , C_v , and C_a values.

universal characteristics

To reach our goal we start by calculating the transfer function of the complete oscillatory circuit. Then if we indicate

$$\omega = 2\pi f$$

$$C = \frac{C_1 \cdot C_2}{C_1 + C_2}$$

$$X_L = j\omega l$$

$$X_v = -j \frac{1}{\omega C_v}$$

$$X_a = -j \frac{1}{\omega C_a}$$

$$X_C = -j \frac{1}{\omega C}$$

the final equation is

$$\bar{Z} = \left(\frac{X_L \cdot X_v}{X_L + X_v} + X_a \right) \cdot \left(\frac{R \cdot X_C}{R + X_C} \right) + \frac{X_L \cdot X_v}{X_L + X_v} + X_a + \frac{R \cdot X_C}{R + X_C}$$

Because of the quantity of calculations I used a computer to solve for \bar{Z} .

As mentioned previously the real oscillator circuit consists of L , C_v , C_a components (see fig. 2). At the resonant frequency, its impedance will equal zero, therefore our complex impedance, \bar{Z} , must also equal zero. The program, in FORTRAN language, was based on the observation above. In fact, the computer printout directly supplied C_v values for that particular frequency value where \bar{Z} equals zero.

parametric curves

Starting from frequency values of 2.5 MHz, and for fixed values of L , C , C_a , and R , we obtained from the computer the C_v values for $\bar{Z} = 0$. The results are summarized in the curves of fig. 3.

Fig. 3A shows the universal characteristics family for $L = 7.5 \mu H$. C_a values vary from 150 to 400 pF in 50-pF

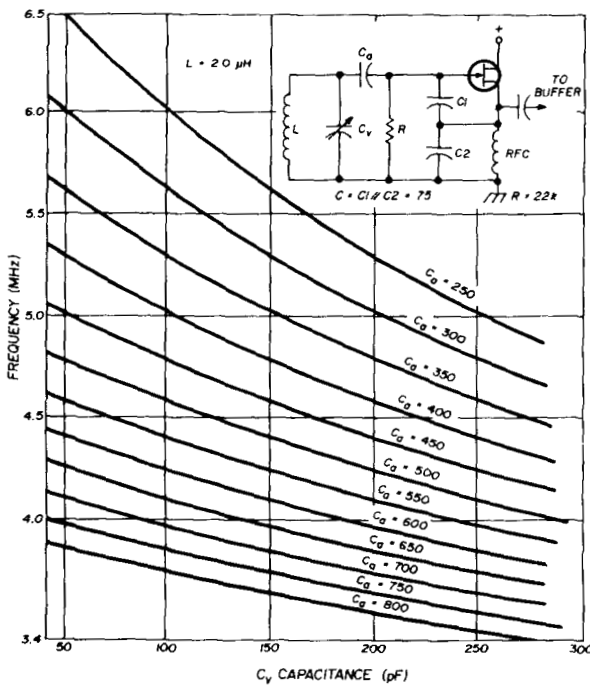
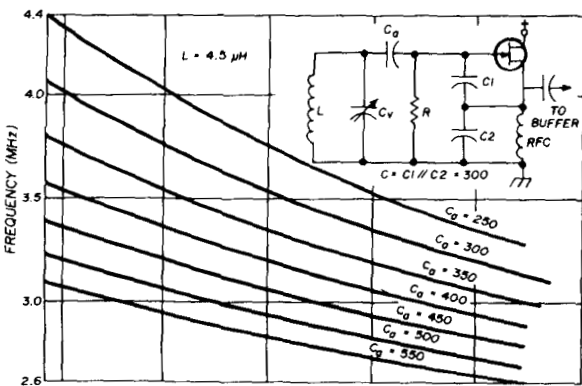
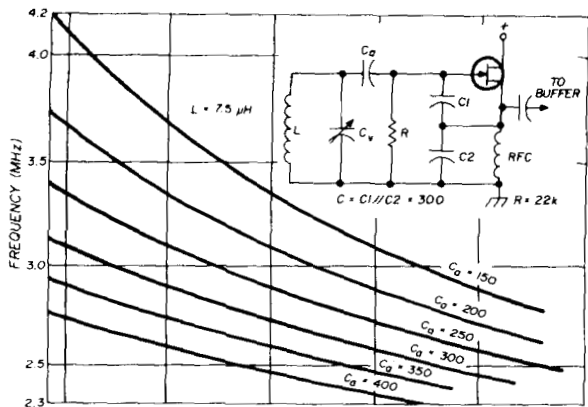

fig. 3. A family of parametric curves for determining component values for the Colpitts vfo in fig. 1. Operating frequency as a function of variable capacitance, C_v , is shown as a function of oscillator frequency with values of C_a as a parameter. The three sets of curves are for various values of inductance, L .

steps. Fig. 3B shows the universal characteristics for $L = 4.5 \mu H$. Seven curves for C_a values between 250 and 550 pF have been calculated.

Fig. 3C refers to the universal characteristics for $L = 2 \mu H$. These curves show that the effect of decreasing L causes an extension of the frequency range of interest by universal characteristics. For the characteristics of figs. 3A and 3B it was not possible to calculate other C_a values because of the unstable conditions I found. Therefore, only 12 curves for C_a , from 250 to 800 pF, have been calculated.

how to use the universal characteristics

I call these characteristics "universal" because they are valid for all vfos (Colpitts) as shown in fig. 1. With these characteristic features you can determine directly the values of all vfo components, as shown in the following example.

Assume you want a variable oscillator covering 3.5-3.9 MHz. Choose two curves, the first from fig. 3B with $C_a = 300 \text{ pF}$ and the second one from fig. 3C with $C_a = 800 \text{ pF}$. In the first case, the linearity ratio value is $\Delta f / \Delta C_v = 4.4 \frac{\text{kHz}}{\text{pF}}$; while in the second case it

is $\Delta f / \Delta C_v = 2.1 \frac{\text{kHz}}{\text{pF}}$. To obtain C_v , (which in this case is 90 pF instead of 190 pF as in the second case) the curve of fig. 3B could be used. From this figure it's possible to get all the other values, which are:

$$\begin{aligned} C_a &= 300 \text{ pF} & C_v &= 90 \text{ pF} \\ L &= 4.5 \text{ pF} & R &= 22 \text{ K} \\ C_1 &= C_2 = 600 \text{ pF} \end{aligned}$$

Usually C_1 and C_2 have the same values to guarantee self-starting oscillations.

in conclusion

Once the working frequency range is chosen, it's possible to satisfy, through the universal characteristics of fig. 3, the following points:

1. Dial linearization; that is, keeping the $\Delta f / \Delta C_v$ ratio constant within the chosen range.
2. Definition of minimum and maximum C_v values.

In any case, for about 200 kHz of frequency range, the linearity error is very low for each curve of the families. On the contrary, for a wider frequency range, the choice of the curve is much more limited and depends on the desired $\Delta f / \Delta C_v$ ratio; that is the derivative value of the curve. Generally, for the $\Delta f / \Delta C_v$ ratio, it's advisable not to select very high values, around 4 kHz/pF.

ham radio

EXPERIENCE. There's no substitute for it. And TEN-TEC has it. More experience in solid-state HF technology than any other amateur radio manufacturer. Because TEN-TEC produced the first all solid-state HF transceiver for amateur radio. So, it stands to reason that the latest generations (the 540/544 models) benefit the most from that experience — in features, reliability, and operating ease. They are the "voices of experience."

TAKE MECHANICAL DESIGN. Experience tells us: make it rugged. So, like all fine solid-state devices such as computers and good test equipment, the 540/544 transceivers have their strength built into the chassis — the case is merely a cover. Ruggedness is carried over into the circuit boards as well. Component leads are "clinched," not just inserted, to give additional strength and to prevent annoying intermittents.

TAKE PHYSICAL APPEARANCE. Experience tells us: keep it simple. WWII is over, so is its technology, so why should your transceiver look like war surplus? The 540/544 transceivers look like tomorrow — small because technology makes it possible — few controls for the same reason. And they're elegantly handsome with black cases and brushed aluminum front panels.

TAKE ELECTRICAL DESIGN. Experience tells us: push the state-of-the-art. Example: we pioneered high power solid-state design for HF amateur radio gear. The advantages are numerous: efficient, small size, no lethal voltages, less heat, longer life, greater reliability. Example: broadband design. The advantages: easier operation for everyone, rag-chewers, DX chasers, even net operators. No out of resonance danger, no need for a dummy load to prevent tune-up QRM, no boring, time-consuming "tune-up" procedures. Another example: computer aid. In circuit design, in manufacturing, for speed and optimization. Example: computer compensating oscillator drift to achieve rock-like stability.

TAKE SERVICING. Experience tells us: make it easy, for everyone. So the 540/544 transceivers have modular design with plug-in circuit boards. And trouble-shooting (if it's ever needed) can be done by you with ordinary test equipment. (Of course, Ten-Tec service people are ready to help).

TAKE OPERATING CONVENIENCE. Experience tells us: everyone wants it. Examples: high sensitivity with low internal noise makes the 540/544 transceivers great for DX, especially during poor band conditions. Full break-in on CW turns conventional QSOs into interesting conversations. Pre-selectable ALC gives automatic level control at various input powers (40-200 watts) plus optimized input power for linear amplifiers. "Semi-hard" keying effectively penetrates pileups, QRM, and QRN, yet is highly articulate and pleasant to copy. Pulsed calibrators are easy to identify. VOX that eliminates "anti-VOX" by triggering on a tone present in your voice but not in the transceiver speaker. (There are even more conveniences in the following "features" list.)

FEATURES — • Instant Band Change (no xmtr. tune-up) • Covers 3.5 to 30 MHz (plus One-Sixty with option) • 200 Watts Input — all bands • Receiver Sensitivity 0.3 μ V • VFO changes less than 15 Hz per F $^{\circ}$ after 30 min. warm-up • 8-pole Crystal IF Filter • Direct Readouts — choose LED digital model or 1 kHz dial model • Optional 150 Hz CW filter • Optional Noise Blanker • Offset Tuning • WWV at 10 & 15 MHz • Separate Receive Capability • Automatic Sideband Selection, Reversible • Sidetone Level and Pitch control • Pre-Settable ALC • 100% Duty Cycle • S Meter and SWR Bridge • LED indicators for ALC and OFFSET • Modular Plug-In Circuit Boards • Broad Accessory Line

544 Digital — \$869 540 Non-Digital — \$699

Give your voice the Ten-Tec "Voice of Experience" treatment. See the 540/544 transceivers at your Ten-Tec dealer or write for full details.

TEN-TEC, INC.
SEVIERVILLE, TENNESSEE 37862
EXPORT 1175 LINDEN AVE. CHICAGO, ILL. 60648

THE VOICE OF EXPERIENCE



rf chokes

their performance above and below resonance

An investigation into the properties of rf chokes over wide frequency ranges

For years I've heard various electronics engineers quote a simple rule-of-thumb about rf chokes: "Never use an rf choke above its self-resonant frequency because it's capacitive!" The inference is, I think, that above its self-resonant frequency, the rf choke will have a very low reactance, which is the opposite effect usually desired from an rf choke. After all, capacitors are used for bypass and coupling functions, and an rf choke *does* show capacitive reactance above its self-resonant frequency.

This rule-of-thumb is a very safe and conservative way to apply rf chokes in circuit design, I suppose, but sometimes it makes it difficult to get the impedance you want over a desired frequency range; in general, the larger the inductance of an rf choke, the lower will be its self-resonant frequency.

A frequent application of rf chokes by amateurs is the use of a 2.5 millihenry choke in a circuit which operates up to 30 MHz. Such use is in direct conflict with the stated rule-of-thumb, because the self-resonant frequency of these chokes is usually on the order of 3 MHz! In the paragraphs which follow, I have attempted to resolve this conflict by mathematical analysis.

mathematical analysis of the rf choke

To evaluate the performance of rf chokes at different frequencies, I felt it necessary to develop a gen-

eral mathematical expression for impedance as a function of self-resonant frequency. Starting with the mythical ideal rf choke, we have a pure inductor as shown in **fig. 1**. The equation for its impedance in ohms is

$$Z = j2\pi fL \quad (1)$$

where Z is the impedance, f is frequency in Hertz, and L is inductance in henries. The j is simply a notation which indicates that the phase angle of the impedance is $+90^\circ$ with respect to a pure resistance. To simplify the following equations a little, I will substitute ω for $2\pi f$

$$\omega = 2\pi f \quad (2)$$

where ω is frequency in radians-per-second. You can always get back to frequency in Hertz by a rearrangement of **eq. 2**.

$$f = \frac{\omega}{2\pi} \quad (3)$$

The solid line on the graph of **fig. 2** shows how the impedance of a pure inductor, having an inductance of 1 henry, rises linearly with increasing frequency, according to **eq. 1**. The linear relationship will continue to any frequency.

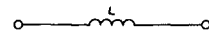

fig. 1. The ideal rf choke is a pure inductance.

Practical rf chokes, however, are not pure inductors; stray capacitance between turns of the coil is effectively in parallel with the ideal inductor. For the purpose of this discussion all of the stray capacitance may be lumped into one equivalent parallel capacitor, as shown in **fig. 3**. The rf choke now has a self-resonant frequency whose value is determined by the values of L and C . The equation for the impedance of this parallel circuit is

$$Z = \frac{(j\omega L) \frac{1}{-j\omega C}}{j\omega L + \frac{1}{-j\omega C}} = \frac{j\omega L}{1 - \omega^2 LC} \quad (4)$$

The self-resonant frequency of the circuit will be

By Courtney Hall, WA5SNZ, 7716 La Verdura Drive, Dallas, Texas 75248

designated ω_o , and its value is

$$\omega_o = \frac{1}{\sqrt{LC}} \quad (5)$$

If ω_o is substituted for ω in eq. 4, we obtain the value of the choke's impedance at the self-resonant frequency.

$$Z_o = \frac{j\omega_o L}{1 - \omega_o^2 LC} = \frac{j\omega_o L}{1 - \left(\frac{1}{LC}\right) LC} = \frac{j\omega_o L}{1 - 1}$$

The denominator in eq. 6 is equal to zero, so the impedance, Z_o , must be infinitely large (remember, we don't have any losses in our mathematical model, yet).

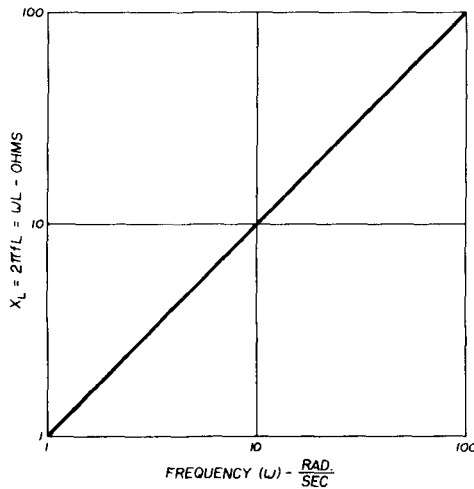

fig. 2. Reactance of a pure 1 henry inductor vs frequency (no stray capacitance or loss resistance).

To solve for the choke's impedance at one octave below and above the self-resonant frequency, substitute $\frac{\omega_o}{2}$ and $2\omega_o$, respectively, for ω in eq. 4

$$\begin{aligned} Z_{\frac{\omega_o}{2}} &= \frac{j\left(\frac{\omega_o}{2}\right) L}{1 - \frac{\omega_o^2}{4} LC} = \frac{j\left(\frac{\omega_o}{2}\right) L}{1 - \frac{LC}{4LC}} \\ &= \frac{2}{3} (j\omega_o L) \end{aligned} \quad (7)$$

$$\begin{aligned} Z_{2\omega_o} &= \frac{j(2\omega_o) L}{1 - 4\omega_o^2 LC} \\ &= \frac{j(2\omega_o) L}{1 - \frac{4LC}{LC}} = -\frac{2}{3} (j\omega_o L) \end{aligned}$$

Let's closely examine these two results. Notice that the quantity $(j\omega_o L)$ in each answer is the reactance a pure inductor would have at ω_o , the frequency at

which the practical choke is self-resonant. Notice too that the magnitudes of the two answers are equal; the choke has as much impedance one octave above the self-resonant frequency as it does one octave below. The minus sign of the impedance one octave above self-resonance indicates the impedance has a phase angle of -90° with respect to a pure resistance, and this means it is a capacitive reactance.

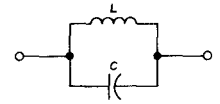

fig. 3. Practical rf choke has stray capacitance, creating a resonant circuit.

To explore this a little further, let's find the choke's impedance one decade below and above self-resonance

$$\begin{aligned} Z_{\frac{\omega_o}{10}} &= \frac{j\frac{\omega_o}{10} L}{1 - \frac{\omega_o^2}{100} LC} = \frac{j\frac{\omega_o}{10} L}{1 - \frac{LC}{100LC}} = \frac{10}{99} (j\omega_o L) \quad (9) \\ Z_{10\omega_o} &= \frac{j(10\omega_o) L}{1 - 100\omega_o^2 LC} \\ &= \frac{j(10\omega_o) L}{1 - \frac{100LC}{LC}} = -\frac{10}{99} (j\omega_o L) \end{aligned}$$

Again, both answers have the same magnitude, and the impedance is inductive below self-resonance and capacitive above self-resonance. I have solved for the choke's impedance at several more frequencies and plotted the curve shown in fig. 4. Although the choke's impedance is capacitive above self-resonance, it doesn't fall off any faster than it does below self-resonance.

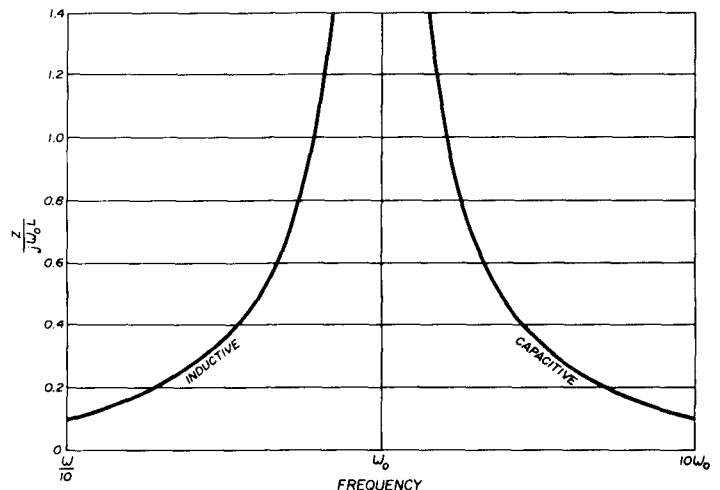

fig. 4. Relative frequency response of a lossless, but self-resonant rf choke. The frequency of resonance is at ω_o .

We must add an equivalent parallel resistance, R_p , as shown in **fig. 5**, to make the mathematical choke completely realistic. Another way to show this is pictured in **fig. 6**, where R_p is connected in parallel with the impedance, Z , solved for above. R_p accounts for losses in the choke; at the self-resonant frequency, the impedance of the choke will be equal to R_p .

The value of R_p does not stay constant as frequency changes because losses tend to increase at higher frequencies. A major contributor to this characteristic is the skin effect in the wire of the coil, which causes R_p to decrease as a function of the square-root of frequency. Solving for the exact impedance of the rf choke with R_p present is a little tedious and will not be dealt with here. It is assumed, however, that R_p will be large enough so that the calculations above may be taken as rough approximations at fre-

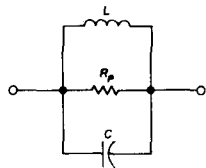

fig. 5. Equivalent parallel resistance, R_p , accounts for losses in rf chokes.

quencies at least one octave away from self-resonance. Thus the curve of **fig. 4** is assumed to be roughly correct outside the frequency range from $0.5\omega_o$ to $2\omega_o$. An example may help to verify this.

example

Using manufacturer's specifications for a typical 2.5 mH rf choke, let's examine its performance using the relationships developed above. Inductance is specified as 2.5 mH at 250 kHz with a Q of 55. The choke's reactance and R_p at 250 kHz are

$$X = 2\pi(.25 \times 10^6) (2.5 \times 10^{-3}) = 3927 \text{ ohms} \quad (11)$$

$$R_p = QX = 55 \times 3927 = 215,985 \text{ ohms} \quad (12)$$

Self-resonant frequency is given as 2.5 MHz. Therefore,

$$j\omega_o L = j(2\pi f_o) L = j(2\pi \times 2.5 \times 10^6) (2.5 \times 10^{-3}) \\ = j39,270 \text{ ohms} \quad (13)$$

Assuming R_p has decreased by the square-root of frequency change, we can estimate its value at 2.5 MHz as

$$R_p = \frac{215,985}{\sqrt{\frac{2.5 \text{ MHz}}{.25 \text{ MHz}}}} = \frac{215,985}{\sqrt{10}} = 68,300 \text{ ohms} \quad (14)$$

Dividing R_p by $j\omega_o L$, we find the choke's Q at 2.5 MHz is about 1.74, a very low value. To satisfy our curiosity, let's see what the value of the equivalent parallel capacitor is. The capacitor's reactance must

fig. 6. Another way of schematically representing an rf choke. Z is the lossless impedance calculated in the text.

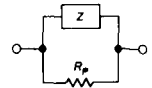

equal the inductor's reactance at resonance, so

$$C = \frac{1}{2\pi(2.5 \times 10^6) (39,270)} = 1.6 \text{ pF} \quad (15)$$

Now let's see what sort of impedance the choke has at 25 MHz, one decade above its self-resonant frequency. Substituting the results of **eq. 13** into **eq. 10**

$$Z_{10\omega_o} = -\frac{10}{99} (j\omega_o L) = -j \frac{10}{99} (39,270) = -j3967 \text{ ohms}$$

The value of R_p at 25 MHz is estimated to be

$$\frac{215,985}{\sqrt{\frac{25 \text{ MHz}}{.25 \text{ MHz}}}} = \frac{215,985}{\sqrt{100}} = 21,598.5 \text{ ohms} \quad (17)$$

so it won't cause too large an error in the result of **eq. 16**. Notice that the impedance at 25 MHz, one decade above self-resonance, is very nearly the same as the impedance at 250 kHz, one decade below self-resonance (see **eq. 11**).

One final calculation of interest is the value of capacitance the choke represents at 25 MHz

$$C = \frac{1}{2\pi(25 \times 10^6) (3967)} = 1.6 \text{ pF} \quad (18)$$

Well, how about that? The same value as at self-resonance. Obviously, the equivalent parallel capacitance of the choke is totally dominating the value of reactance at 25 MHz. But then, it should.

conclusion

After going through the exercise above, it is evident that an rf choke behaves like any parallel tuned circuit. But since an rf choke has a self-resonant frequency, we knew it was just a parallel tuned circuit all along, didn't we? If we can use an rf choke below its self-resonant frequency, I see no reason not to use it above its self-resonant frequency, so long as it will provide the required impedance. An rf choke does look like a capacitor above self-resonance, but as we saw with the 2.5 mH choke, it can be a very small capacitor.

ham radio

DIVISION OF BROWNIAN ELECTRONICS CORP.
320 WATER ST / BINGHAMTON, N.Y. 13901 / Phone 607-723-9574



Vhf engineering



499.95	Repeater-2 meter-15w-complete (less crystals)
499.95	Repeater-220 MHz-15w-complete (less crystals)
579.95	Repeater-432MHz-10w-complete (less crystals)
799.95	Repeater-2 meter-15w-factory wired and tested
799.95	Repeater-220 MHz-15w-factory wired and tested
849.95	Repeater-432 MHz-10w-factory wired and tested

PRICES

Not shown in photo is new power supply. Has fold back current limiting (you can short supply & will not damage it), also over voltage protection (a short in the supply will shut it down so repeater is not damaged.) Don't forget our CMTD with its 159 bit field programmable memory.

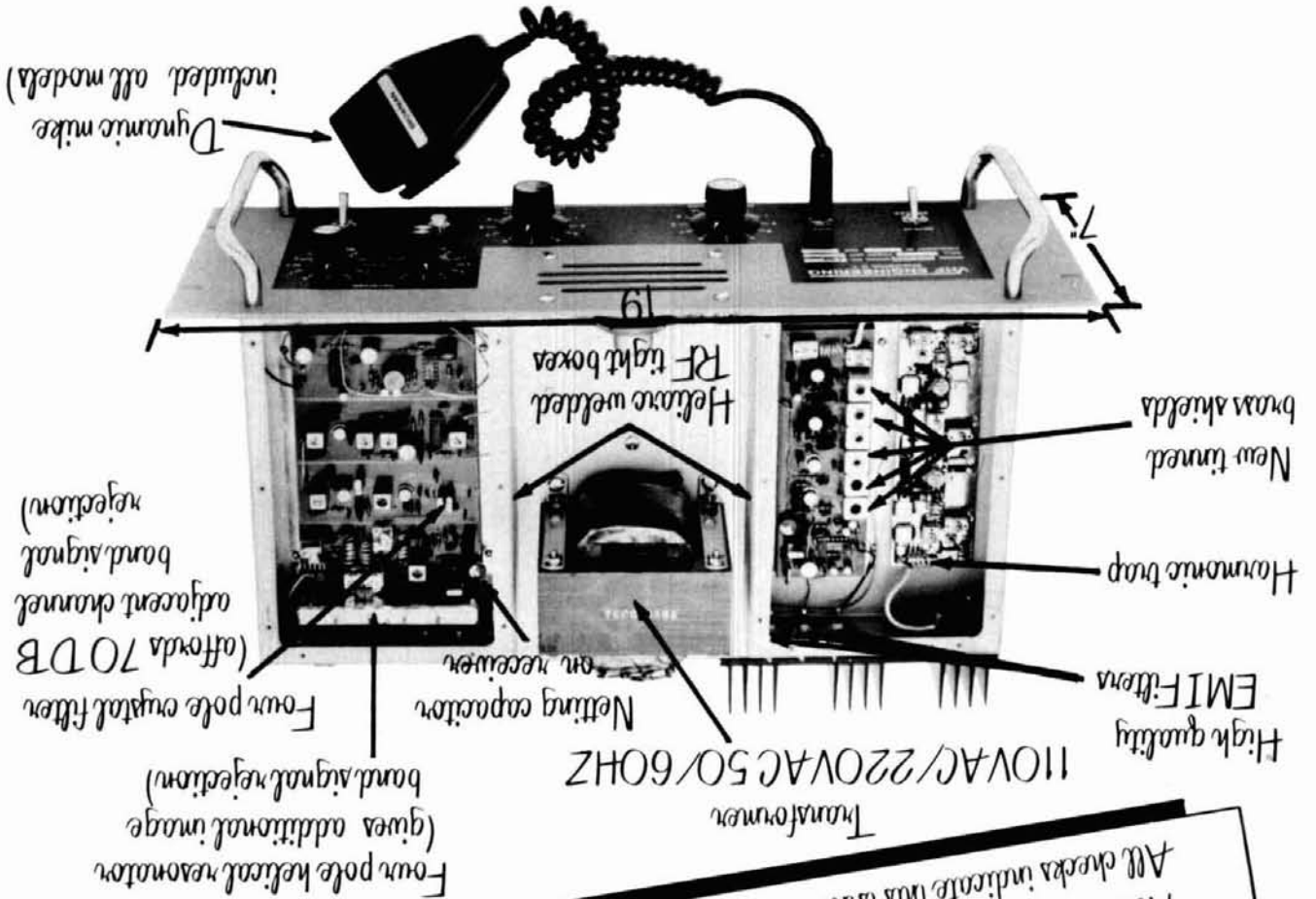

INTER-OFFICE MEMO

TO: TOM BALL, Sales Manager
FROM: ROBERT BROWN, Chief Engineer

Here is the information on our "B" series of repeaters. All features are standard on all units; kits as well as wired. All checks indicate this is the hottest repeater on the market.

Standard features on all repeaters (Kit or Wired & Tested) B series.

techniques for preventing rf leakage from your transmitter

Lowering unwanted
rf leakage
from your transmitter
reduces
radio-frequency
interference

We are all aware of the increasing incidence of RFI problems caused by solid-state home entertainment products which are not designed to function normally in the presence of a strong RF field. These kinds of problems can be cured only by adding filtering and/or shielding to the affected device.

At the same time it behooves us all not to forget to be sure that our own transmitters are clean. This means using a good lowpass filter and making sure that the only path out of the transmitter for rf energy is through that lowpass filter. If you have any RFI problems, this is the first thing that should be checked.

Run your transmitter into a shielded dummy load. If the RFI is still present, you have rf leakage which should be eliminated. If it is harmonic interference, no lowpass filter will do any good if the harmonics are leaking out ahead of it. If it is overload interference, it may be possible to eliminate it by curing the leakage, depending on the amount of leakage to begin with and the relative distances from the equipment and the antenna to the device suffering the interference.

Three areas need to be addressed to solve rf leakage problems: filtering of power, audio, and control leads; shielding effectiveness of coaxial cable; and leakage at joints in shielded enclosures. Techniques

By John E. Becker, K9MM, 201 East Marion Street, Prospect Heights, Illinois 60070

for filtering of power, audio, and control leads has been thoroughly discussed in many amateur publications so that topic will not be addressed here. Instead, I will concentrate on the other two areas.

There is considerable difference in the shielding efficiencies of different types of coaxial cable. The numbers to be quoted are from manufacturers' literature, and while different manufacturers do not necessarily agree on the shielding efficiency of a particular type of cable, there is no doubt about the significant difference in the shielding efficiency afforded by the different types of cable construction to be discussed, and the numbers should be considered with that in mind. The most commonly used type of coax, that having a single shield braid of stranded copper wire, has a shielding efficiency of -48 dB at 100 MHz for a 30 cm (1 foot) length of cable. That is, the total power radiated by that 30 cm of cable is 48 dB down from the signal level in the cable. This assumes 95 per cent shield coverage. This shielding efficiency increases only slightly with decreasing frequency, to -52 dB at 10 MHz according to data published by the Times Wire and Cable Company.

The shielding efficiency is significantly reduced by lower shield coverage, and 85-90 per cent is more typical. This means that if you have 30 cm of coax between your transmitter and lowpass filter, harmonics radiating from that piece of coax are 48 dB down from their level at the transmitter output. Under these conditions, a lowpass filter with 100 dB harmonic attenuation is no better than one with 48 dB attenuation as far as nearby interference problems are concerned. The filter will keep the harmonics from getting to the antenna to be radiated for long distances, but the TVI problem next door is just as likely to be due to the radiation from the cable.

While we're still on the subject of single shielded coax, be especially wary of bargain priced coax that is not made to military specifications. Some manufacturers have drastically reduced shield coverage in the last few years to keep costs down.

There are more sophisticated types of coaxial cable with much better shielding efficiencies. The most often encountered construction is double shielded coax. This type of cable uses two shield layers with no dielectric between them. Shielding efficiency is typically -87 dB at 100 MHz for a 30 cm (1 foot) length, and since this is a premium cable designed for excellent shielding you can be sure that the shield coverage is as great as possible.

A still better type of construction for shielding efficiency is triaxial cable. This cable has two shield layers with a dielectric layer between them. Shielding

efficiency is further improved to -97 dB at 100 MHz for a 30 cm length.

The ultimate in shielding efficiency is the solid jacketed type of cable. Radiation from this type of cable is below measurable limits, and system shielding efficiency is limited only by leakage at a connector interface.

The use of one of these improved types of cable for all station interconnections up to the lowpass filter will ensure that you are getting all the harmonic protection the filter is capable of. Double-shielded substitutes for RG-8A/U or RG-213/U are RG-9B/U or RG-214/U. The double-shielded substitute for RG-58C/U is RG-55A/U or RG-223/U. A triaxial substitute for RG-8A/U or RG-213/U is Times TRF-8. A triaxial substitute for RG-58C/U is Times TRF-58 or Essex 21-204.

Whatever kind of cable is used, be sure the connectors are properly installed. An improperly attached shield will seriously degrade shielding effectiveness. With double-shielded and triaxial cables, both shields should be attached to the connector shell at both ends of each cable run. Assembly instructions for UHF, N, and BNC connectors can be found in both the ARRL *Handbook* and *Antenna Book*.

For sealing joints of shielded enclosures, the 3M company has two products that are hard to beat for effectiveness and ease of application. They are copper foil tapes with conductive adhesives, especially designed for RFI shielding. Type X-1181 is a smooth tape, and type X-1245 is embossed with a grid pattern for more reliable electrical contact with the surface on which it is applied. Both are available in widths from 6 to 25 mm (1/4 to 1 inch). Shielding efficiency of up to -65 dB is claimed by 3M, depending on the type of metal the tape is applied to. If desired, it is possible to solder to the tape without damaging it.

I have applied this tape to the edges of all shield enclosures in my equipment, to the seams of lowpass filter boxes, and over the edges of coax connectors. The same piece has been removed and re-applied on my linear amplifier cover shield several times with no apparent loss of adhesion. If the metal surface is clean to begin with, the adhesion is excellent. This type of tape may also be spirally wound over a length of conventional single shielded coax to obtain improved shielding efficiency. Each turn should overlap the previous turn by half the width of the tape, and the tape should extend over the shell of the connector at each end.

ham radio

ATB-34

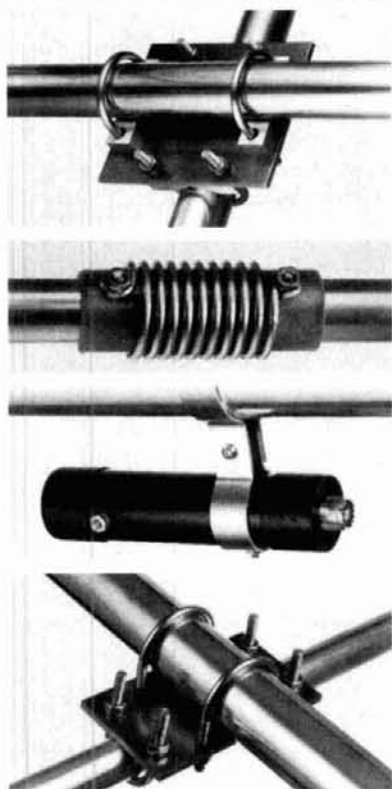
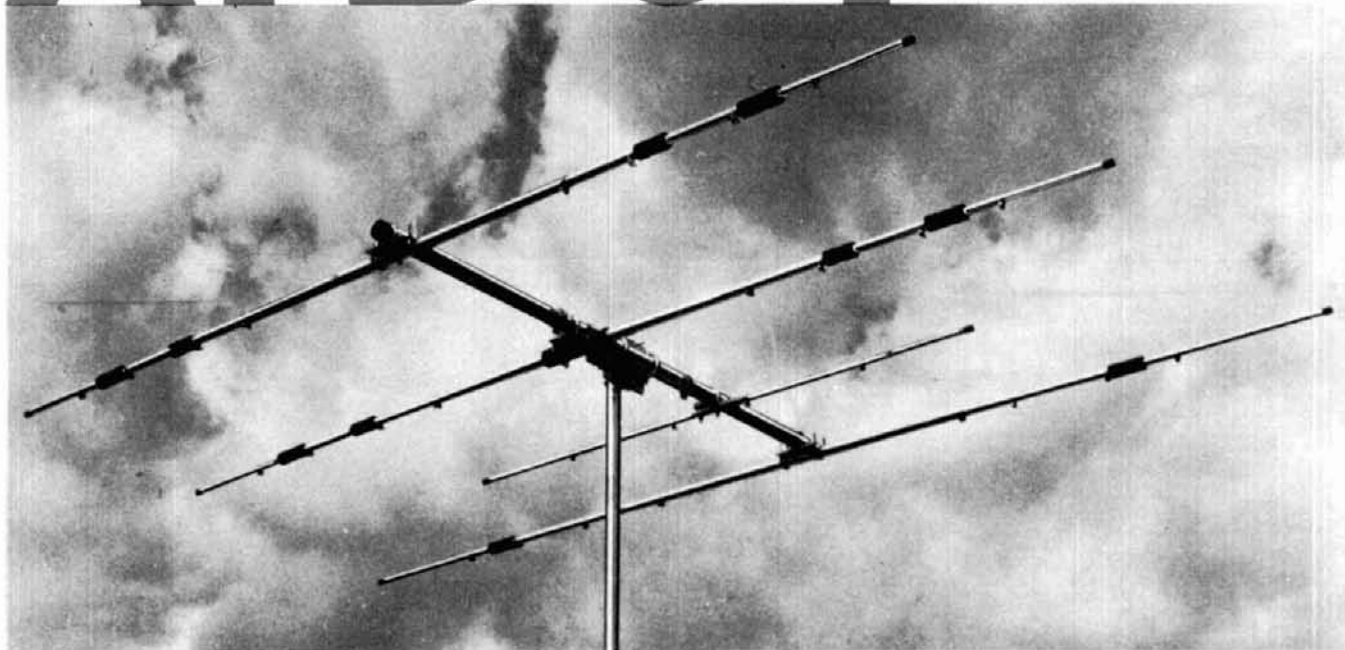

4 ELEMENT-3 BAND 10-15-20 METER BEAM

Cushcraft engineers have incorporated more than 30 years of design experience into the best 3 band HF beam available today. ATB-34 has superb performance with three active elements on each band, the convenience of easy assembly and modest dimensions. Value through heavy duty all aluminum construction and a price complete with 1-1 balun.

Enjoy a new world of DX communications with ATB-34!

SPECIFICATIONS

FORWARD GAIN -	7.5 dBd	WIND SFC -	5.4 Sq.Ft.
F/B RATIO -	30 dB	WEIGHT -	42 Lbs.
VSWR -	1.5-1	WIND SURVIVAL -	90 MPH.
POWER HANDLING -	2000 WATTS PEP		
BOOM LENGTH/DIA. -	18' x 2 1/8"		
LONGEST ELEMENT -	32'8"		
TURNING RADIUS -	18'9"		

UPS SHIPPABLE
IN STOCK WITH DISTRIBUTORS WORLDWIDE

COMPLETE
NO EXTRAS TO BUY



cushcraft

CORPORATION

BOX 4680, MANCHESTER, N.H. 03108

NEW

HF VERTICALS BY CUSHCRAFT

10-15-20 METERS

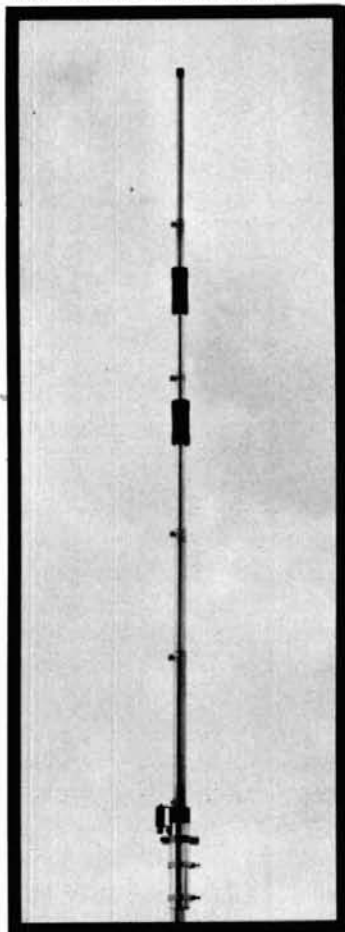

ATV-3 Cushcraft's ATV-3 multiband vertical provides low VSWR operation for both SSB and CW on 10, 15, and 20 meters. Matched to 50 ohms, built-in connector mates with standard PL-259. Stainless-steel hardware is used for all electrical connections. The ATV-3 is a compact 166 inches (4.2 meters) tall. Rated at 2000 watts PEP.

10-15-20-40 METERS

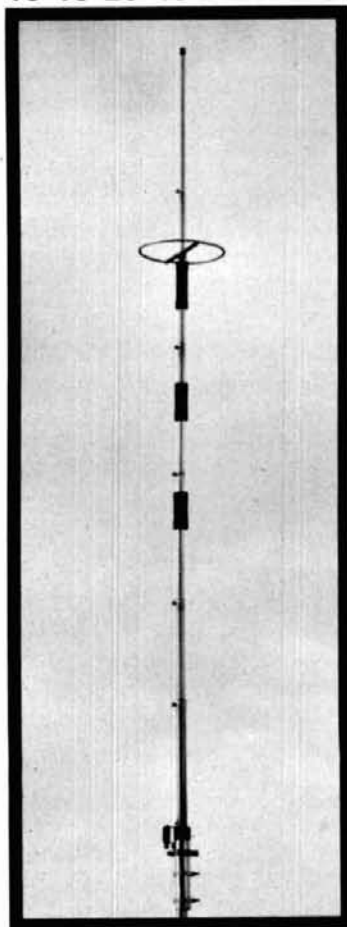

ATV-4 The Cushcraft ATV-4 four-band vertical antenna has been optimized for wide operating bandwidth on 10, 15, 20, and 40 meters. SWR is less than 2:1 over the CW and SSB segments of 10, 15, and 20. The 2:1 SWR bandwidth on 40 meters is approximately 240 kHz, may be quickly and easily adjusted to favor any part of the band. Coaxial fitting takes 50-ohm transmission line with PL-259 connector. Overall height, 233 inches (5.9 meters). Rated at 2000 watts PEP.

10-15-20-40-80 METERS

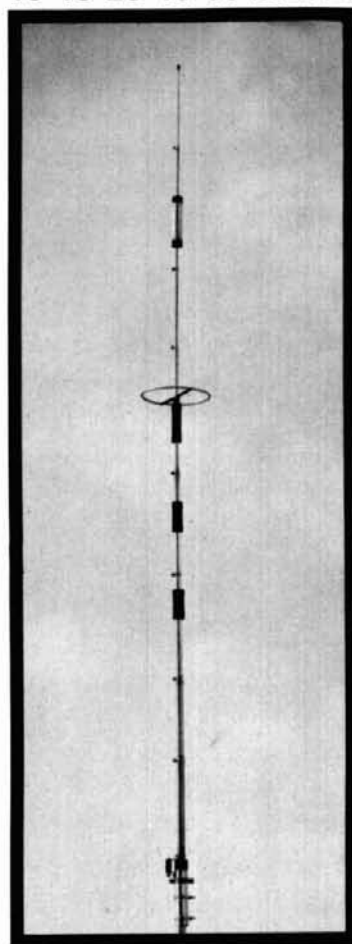

ATV-5 The ATV-5 trapped vertical antenna system has been engineered for five-band operation on 80 through 10 meters. The high Q traps are carefully optimized for wide operating bandwidth: 2:1 SWR bandwidth with 50-ohm feedline is 1 MHz on 10 meters, more than 500 kHz on 15 and 20 meters; 160 kHz on 40 meters; and 75 kHz on 80 meters. Instructions are provided for adjusting resonance to your preferred part of the band, CW or SSB. Built-in coaxial connector takes PL-259. Nominal height, 293 inches (7.4 meters). Rated at 2000 watts PEP on **all** bands.

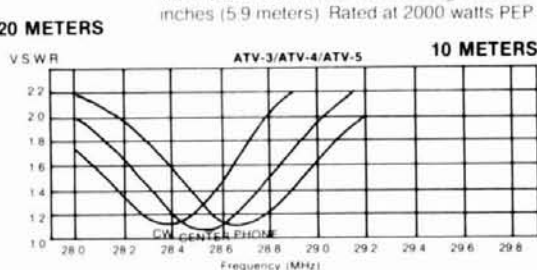
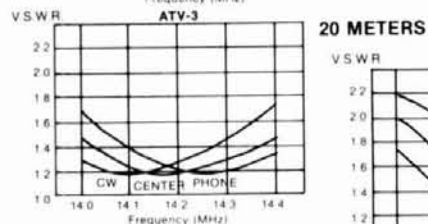
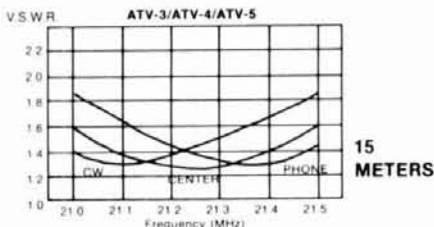

UPS SHIPPABLE

cushcraft
CORPORATION

THE ANTENNA COMPANY

IN STOCK WITH DEALERS WORLDWIDE
P.O. BOX 4680, MANCHESTER, NH 03108

simple and effective vertical antenna

for portable communications

How to build
a simple
vertical antenna mount
that can be
set up quickly
for emergency
radio communications

One of the important aspects of amateur radio is the provision for efficient and timely communications in emergency or disaster situations. Having been a ham for several years I have found it interesting that, in the various ham-oriented magazines, there is substantial coverage given for proper procedures to follow during disaster or emergency communications but little mention or suggestion for effective and simple antenna systems. The following presents an idea which fulfills both the "simple" as well as "effective" aspects of an emergency antenna set-up and is easy and inexpensive to make. The secret to success is in the use of a vertical antenna (for the bands you intend to operate) with ground radials, and a homebrew base section which mounts in the spare tire from your vehicle (see fig. 1).

construction

The materials required to build the base section are a short length of mast or pipe and a front wheel hub that will bolt into your vehicle's spare tire (the wheel hub can be obtained from a local junk yard for a few dollars). You will also need a set of lug nuts that will fit the bolts on the hub.

The outside diameter of the mast should be as close to the inside diameter of the outside grease-seal surface of the hub as possible to make it easier

to position the mast perpendicular to the hub. The mast must be welded to the hub.

Clean the hub of all oil or grease. Place it on a hard surface (that will not burn) with the lug-bolts facing up, stand the mast in the hub, and weld the mast and hub together as pictured in fig. 2. Be sure to position the mast perpendicular to the hub so the antenna will be straight and not tilted to one side or the other.

field use

To use the antenna set-up for emergency or portable operation (such as Field Day or a camping trip)

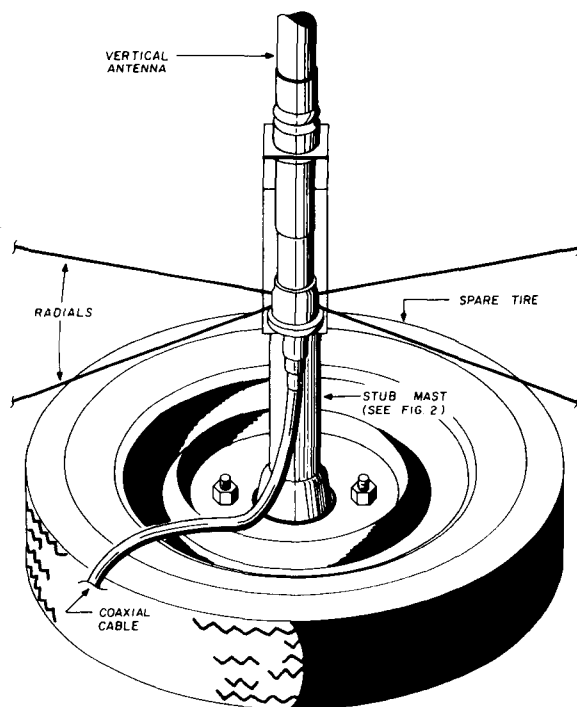

fig. 1. Portable vertical antenna mount consists of a junk-yard hub bolted to the spare tire from your car. In high wind conditions you may want to weight the tire down with rocks, but in most cases this isn't necessary. Construction of the hub section is shown in fig. 2.

all you need to do is remove the spare tire from your automobile, bolt in the base-section, lay the spare on the ground so the mast points up, and mount the antenna on the mast. If the vertical leans to one side, remove some dirt from under the high side of the tire or place some dirt, rocks, or a board under the low side to correct it. If you wish, you can place several

By John S. Jolly, WA7NWL, 1840 North
64th Lane, Phoenix, Arizona 85035

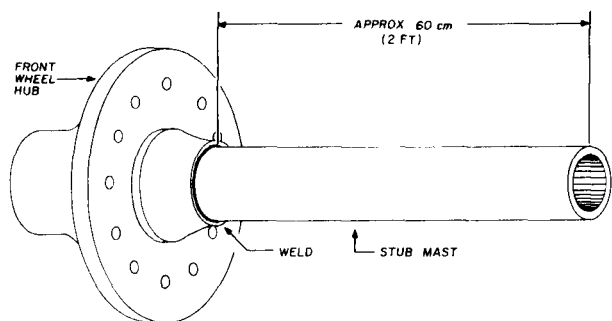

fig. 2. Stub mast for the portable antenna base consists of a front hub from the junk yard which fits your car, and a short steel mast which is welded to the hub. The outside diameter of the short mast should be very close to the inside diameter of the hub's grease-seal surface so the mast is perpendicular to the stub.

rocks on top of the spare for additional weight and stability (under normal conditions this should not be necessary). Attach the ground radials and coax, and you are ready to go on the air.

conclusion

It is the intent of this article to describe a relatively simple and inexpensive method for an average amateur to have an antenna set-up which is portable and effective for use when conditions necessitate it. In addition to emergency and portable use, this set-up could be used by those hams living in apartments or townhouses which forbid permanent fixture on their roofs.

ham radio

cleanup tips for amateur equipment

Being in a position that would be considered enviable among some amateur radio operators (this was written during my fifth year in the R.L. Drake Company Customer Service Department; I now work for ETO), I've been able to pick up on some tips and hints on routine maintenance for amateur equipment. Even though I work for one of the manufacturers, don't wrinkle your nose and flip the page in favor of the ads on the latest offerings from your local dealer. What I'm going to talk about is directly applicable to any amateur equipment.

The item I want to deal with is cleaning the exterior of your gear. The benefits here are numerous; you can operate without having an air-sick bag handy, most technicians would rather spend an hour giving the gear a little extra tweaking instead of cleaning it, and it keeps the wife from nagging you about operating a home for wayward cockroaches.

For those of you who smoke, the gear really gets coated with tobacco stains in a hurry. The primary reason for this fact is that most of us get so wrapped up in a hot contest that we wind up with two cigarettes between the lips and three burning in the ashtray without realizing it. In time, the panel markings get dim and blurred and you find yourself shading the vfo with one hand while squinting your eyes trying to read the numbers and keying with the other.

There are only two cures for this condition that I know of. One is to stop smoking (if you have the willpower — I don't), the other is a couple of products called *Sani-Wax* and *Fantastik* along with about two hours work. Even if you decide to quit smoking, you still have the gear to clean up or trade in, and clean equipment almost always brings a few extra bucks when you trade.

Sani-Wax is a white liquid that comes in a handy-

dandy plastic quart container and retails for a dollar ninety-nine in my neck of the woods. The things it does for metal panels and cabinet borders is magnificent. It's the only product I've used that will cut through smoke, grease, oil, and coffee stains while leaving a nice shine behind. The best part is that it goes on easy and wipes off easier.

Fantastik is a spray cleaner from Texize Chemicals Company that will totally fascinate you with what it does for meters, vfo dials and windows, and especially knobs. It knocks the skin oils and accumulated dirt out of the little grooves in those plastic knobs like crazy and it doesn't scratch or discolor them. An old toothbrush makes the job easier and a lot faster. Just make sure you get it back in the rack before your mother-in-law shows up for her weekly overnight visit.

A word of caution before you start. It's a good idea to remove all knobs before beginning and to mark down what position your knobs are in BEFORE removing them. A lot of the controls, particularly bfo, audio/rf gain, passband tuning, and veniers, don't have flatted or keyed shafts to realign the pointers.

If you can't find *Fantastik* at your local supermarket or electronics surplus store, try writing to the Consumer Relations Department, Texize Chemicals Company — Division of Morton-Norwich Products, Inc., Greenville, South Carolina 29602. They can put you hot on the heels of a local distributor. The people at *Sani-Wax* can be contacted by writing to Roger Solem, Market Mechanics, 1900 East Randoll Mill Road, Suite 106, Arlington, Texas 76011.

By using *Sani-Wax* on all the metal parts, and *Fantastik* on all the plastic parts, your amateur equipment will shine like new with a minimum of work.

William D. Fisher

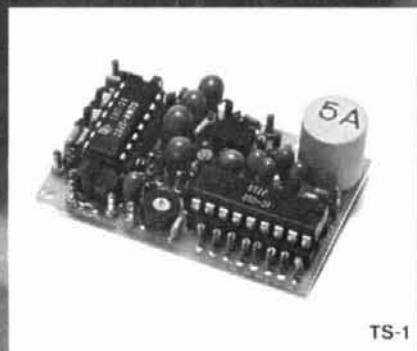

TS-1



TS-1JR



PE-2

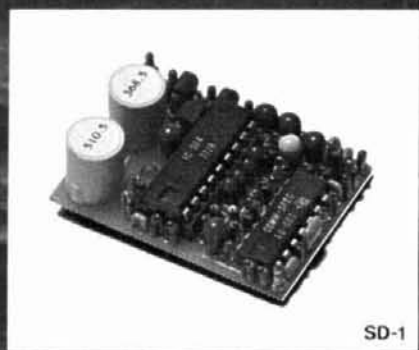

SD-1

THE DAWNING

The age of tone control has come to Amateur Radio. What better way to utilize our ever diminishing resource of frequency spectrum? Sub-audible tone control allows several repeaters to share the same channel with minimal geographic separation. It allows protection from intermod and interference for repeaters, remote base stations, and autopatches. It even allows silent monitoring of our crowded simplex channels.

We make the most reliable and complete line of tone products available. All are totally immune to RF, use plug-in, field replaceable, frequency determining elements for low cost and the most accurate and stable frequency control possible. Our impeccable 1 day delivery is unmatched in the industry and you are protected by a full 1 year warranty when our products are returned to the factory for repair. Isn't it time for you to get into the New Age of tone control?

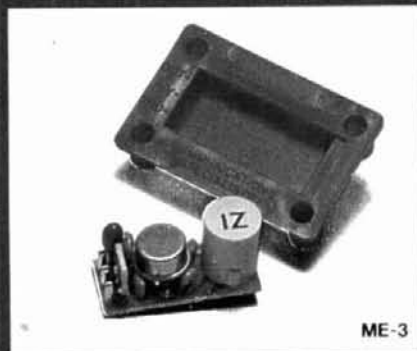

ME-3

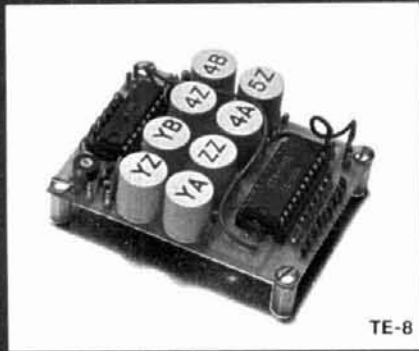

TE-8

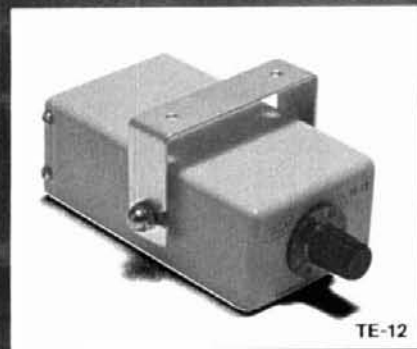

TE-12



ST-1

OF A NEW AGE.

TS-1 Sub-Audible Encoder-Decoder • Microminiature in size, 1.25" x 2.0" x .65" • Encodes and decodes simultaneously • **\$59.95** complete with K-1 element.

TS-1JR Sub-Audible Encoder-Decoder • Microminiature version of the TS-1 measuring just 1.0" x 1.25" x .65", for hand-held units • **\$79.95** complete with K-1 element.

ME-3 Sub-Audible Encoder • Microminiature in size, measures .45" x 1.1" x .6" • Instant start-up • **\$29.95** complete with K-1 element.

TE-8 Eight-Tone Sub-Audible Encoder • Measures 2.6" x 2.0" x .7" • Frequency selection made by either a pull to ground or to supply • **\$69.95** with 8 K-1 elements.

PE-2 Two-Tone Sequential Encoder for paging • Two call unit • Measures 1.25" x 2.0" x .65" • **\$49.95** with 2K-2 elements.

SD-1 Two-Tone Sequential Decoder • Frequency range is 268.5 - 2109.4 Hz • Measures 1.2" x 1.67" x .65" • Momentary output for horn relay, latched output for call light and receiver muting built-in • **\$59.95** with 2 K-2 elements.

TE-12 Twelve-Tone Sub-Audible or Burst-Tone Encoder • Frequency range is 67.0 - 263.0 Hz sub-audible or 1650 - 4200 Hz burst-tone • Measures 4.25" x 2.5" x 1.5" • **\$79.95** with 12 K-1 elements.

ST-1 Burst-Tone Encoder • Measures .95" x .5" x .5" plus K-1 measurements • Frequency range is 1650 - 4200 Hz • **\$29.95** with K-1 element.



**COMMUNICATIONS
SPECIALISTS**

426 W. Taft Ave., Orange, CA 92667
(714) 998-3021

pi network design

for high-frequency power amplifiers

A complete discussion of pi and pi-L networks with computer derived component values for a wide range of operating conditions

The design of rf power amplifiers has always fascinated the typical radio amateur, and it remains one of the few fields in which a person of modest technical capability can still actively participate. Although the number of home-built transmitters has steadily diminished as more commercial companies have entered the market, many amateurs still like to design and build their own final amplifier. The information contained in this article should greatly assist those so inclined. Many interesting comparisons will be presented between amplifiers running at different power levels as well as pertinent computer-derived data for the proper selection of component values.

With single sideband and its legal 2-kW PEP maximum input power, certain problems crop up which many amateurs overlook or are unable to handle. This is because the operator wants to run the amplifier at one power level for ssb and another for CW. The problems are compounded when the operator also wants to run RTTY, which is 100 per cent key-down continuous-carrier operation.

There is also a growing tendency to build power amplifiers with higher plate voltages than were com-

mon a few years ago. Part of this trend is due to the fact that the newer power tubes provide maximum performance at high plate voltages. Many of the pi-network design charts previously published have not been extended to include these higher operating voltages.

pi networks

The pi network is so named because of its resemblance to the Greek letter pi as shown in **fig. 1**. The same network in its electrical form with input and output impedances is shown in **fig. 2**. Since most amateurs use 50-ohm coaxial transmission line, the output load impedance of the pi network is usually 50 ohms.

When the pi network is used in a power amplifier, the circuit looks like that shown in **fig. 3**. The antenna provides the output load impedance, Z_L , and the power tube provides the input load impedance, Z_p . Since the plate load impedance usually falls into the range from 1200 to 5000 ohms, the pi network transforms the high impedance of the vacuum tube into the 50-ohm antenna load. It performs this job quite efficiently, and with predictable results.

Actually, the pi network is a basic form of a three-pole lowpass filter. With proper care in design it will attenuate the second harmonic by 35 dB or more.¹ This would be for a loaded Q of 12; if the Q is doubled, attenuation is increased by approximately 6 dB.

The pi-L network shown in **fig. 4** consists of a standard pi network with an additional inductor. Since the pi-L network is a four-pole lowpass filter, second harmonic attenuation is increased to approximately 50 dB. This is particularly important if you want maximum suppression of TVI.

In addition to increased harmonic suppression, the pi-L network offers greater bandwidth for a given variation in operating Q , requires less output capacitance, and is able to operate efficiently with lower Q at very high plate load impedances. These advantages will become more apparent later.

By Irvin M. Hoff, W6FFC (reprinted from the September, 1972, issue of *ham radio*)

The dc plate resistance of a vacuum tube, at a given input power level, can be calculated with Ohm's law: $R = E/I$, where E is the dc plate voltage and I is the dc plate current. However, since we are dealing with an ac circuit, this is of little value. What we need to know is the plate load impedance. This is

fig. 1. The pi network is so named because of its basic resemblance to the Greek letter π .



given approximately by the following equation which has been derived from the complex functions of a vacuum tube operating in class B.

$$Z_p \approx \frac{E}{1.57I} \quad (1)$$

where Z_p is the plate load impedance, I is the indicated plate current, and E is the dc plate voltage.

When the vacuum tube is operated in class C, as for CW, the plate load impedance is approximated by

$$Z_p \approx \frac{E}{2I} \quad (2)$$

If you are using a linear amplifier that runs with very high idling current, and approaches class A, the following approximation for plate load impedance would be more appropriate.

$$Z_p \approx \frac{E}{1.3I} \quad (3)$$

Zero-bias grounded-grid linears are usually thought of as being class B, but there is no hard and fast rule in this regard. A number of articles has been written on this subject, and you are likely to have already formed some opinions of your own.

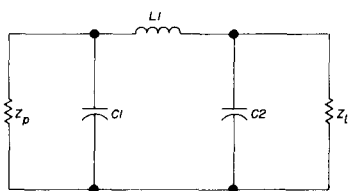

fig. 2. Basic pi network showing the input and output load impedance. The input load impedance in transmitters is the plate load impedance; output load impedance is usually 50 ohms in amateur stations.

Consider the case of a class-B rf power amplifier with a 2100-volt plate power supply and indicated plate current of 476 mA (1kW input). As calculated from eq. 2, the plate load impedance is 2800 ohms:

$$Z_p = \frac{2100}{1.57 \cdot 0.476} = 2800 \text{ ohms}$$

Typical plate load impedances for various power

levels and different operating voltages and currents are shown in table 1. It can be seen from this data that the plate load impedance rises to very high levels when the plate voltage is increased above 4000 volts. More amateurs than might be expected use 4000 to 6000 volt power supplies, and many of the associated problems have not been adequately discussed in the past.

circuit Q

The letter Q stands for quality factor, and is used to describe, in simple numerical terms, the efficiency and performance of capacitors and inductors. Actually, there are two types of Q — loaded Q and unloaded Q . The unloaded Q is the inherent quality factor of the component itself; loaded Q is the quality factor of the component when it is used (and loaded down) by the circuit.

The unloaded Q of a component is given by

$$Q_u = Q(\text{unloaded}) = \frac{X}{r} \quad (4)$$

where X is reactance and r is ac resistance. The unloaded Q of a high-quality capacitor might be 1000 or more, and a silver-plated inductor might have an unloaded Q of more than 500.

The loaded Q of a pi network is usually on the order of 10 to 20 for maximum harmonic attenuation, and is given by:

$$Q_o = Q(\text{loaded}) = \sqrt{\frac{Z_p - Z_L}{Z_L}} \quad (5)$$

where Z_p is the input impedance to the network, and Z_L is the output impedance.

When designing pi networks a value of loaded Q is chosen on the basis of harmonic attenuation, and is used in the design equations to determine the inductance and capacitance values for a given operating frequency.

L-networks

A typical step-down L-network is shown in fig. 5. This network is used to transform its input impedance to a lower output impedance. The Q of this circuit is entirely dependent upon the ratio of the input and output impedances as given in eq. 5.

For example, if the input impedance to an L-network is 2500 ohms, and the output impedance is 50 ohms, the loaded Q of the network is 7:

$$Q_o = Q(\text{loaded}) = \sqrt{\frac{2500 - 50}{50}} = \sqrt{49} = 7$$

However, a loaded Q of 7 is much too low for good harmonic suppression. To determine the L-network input impedance required to provide a desired value of loaded Q , eq. 5 is rearranged as shown below:

$$Z_p = Z_L(Q_o^2 + 1) \quad (6)$$

For example, with an output load impedance of 50 ohms, and a desired loaded Q of 12 (for good harmonic suppression), the required input impedance is 7250 ohms. This is very restrictive and does not allow the designer sufficient latitude. So, although the L network is extremely efficient (98 per cent, typical), a pi network is usually used in transmitter output circuits.

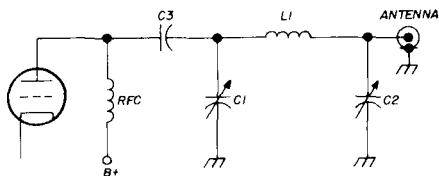

fig. 3. Pi network used in the output of an rf power amplifier is coupled to the power tube through a dc blocking capacitor (C3). C1 is the tuning capacitor, C2 is the loading capacitor, and L1 is the tank inductor.

pi network analysis

You can think of the pi network as being two L networks in tandem as shown in fig. 6. The first L network is a step-down type while the second L network is reversed for impedance step up. As an example, consider the case where the input impedance to the dissected pi network in fig. 6 is 2900 ohms. With a Q of 12, the first L network would step the input impedance down to 20 ohms. This is often called the *virtual impedance*.

$$Z_L = \frac{Z_p}{Q^2 + 1} = \frac{2900}{12^2 + 1} = \frac{2900}{145} = \text{ohms} \quad (7)$$

The second L network would then be designed to raise this virtual impedance of 20 ohms to 50 ohms to match the antenna. The Q of the second section would be quite low, on the order of 1.5.

As the input impedance is increased with Q held constant, the virtual impedance increases, and when the virtual impedance is equal to the desired output impedance, the pi network reverts to an L network. For example, with a plate load impedance of 7250 ohms and a Q of 12, the virtual impedance is 50 ohms. This is the maximum possible impedance transformation for a Q of 12 and an output impedance of 50 ohms.

Normally, about 70 per cent of the maximum pos-

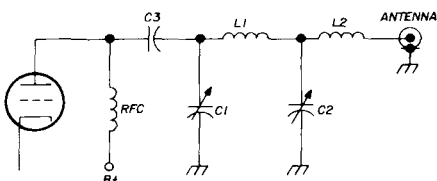

fig. 4. The pi-L network requires an additional inductor and provides increased second harmonic attenuation.

sible impedance transformation is used in a practical circuit. For a Q of 12 and an antenna load of 50 ohms, this would represent a plate load resistance of 5075 ohms. If the plate load resistance in an rf power amplifier is higher than 5075 ohms, a Q of more than 12 is required to retain the same level of harmonic suppression. This problem is circumvented by the use of the pi-L network, as discussed below.

pi-L network design

Another L network may be added to the pi network as shown in fig. 7 for additional harmonic attenuation. In actual practice C2 and C3 are combined into one capacitor so the circuit used in the transmitter is like that shown in fig. 4.

In the pi-L network, the input pi section transforms the plate load impedance to some lower figure, such as 300 ohms; this is often called the *image impedance*. The final L network transforms the image impedance down to 50 ohms to match the antenna.

From eq. 6 it can be seen that with an image impedance of 300 ohms and a Q of 12, the pi network has a maximum transformation of 43500 ohms.

fig. 5. Typical step-down L network is highly efficient but very restrictive as far as acceptable Q is concerned.

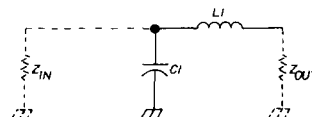

Using 70 per cent of the maximum possible transformation as a practical maximum, as noted before, results in a maximum practical input impedance of 30500 ohms with a Q of 12. This is far in excess of what you will ever need in a power amplifier designed for amateur service.

The image impedance usually falls in the range between 200 and 400 ohms. It is selected for good harmonic attenuation, as well as balance in the T section of the pi-L network, and reasonable component values for the capacitors and inductors. If the image impedance is too high, the tuning capacitor (C1) will be too small on 10 and 15 meters, and the two inductors will be very large. Large inductors, of course, increase circulating currents which result in higher losses due to heat.

Q vs frequency

The loaded Q of a pi network (or any tank circuit, for that matter) is equal to its parallel-resonant impedance divided by either the inductive or capacitive reactance of the network.

$$Q_o = \frac{Z_p}{X} \quad (8)$$

The reactance of any inductor is directly proportional to frequency, increasing as the frequency in-

creases. Therefore, from eq. 8 it can be seen that if a particular inductor is used, loaded Q will vary inversely with frequency. As the frequency is lowered, for example, Q is raised a proportionate amount. With this in mind, it is easy to determine the Q for a given network on a different frequency from the following formula:

$$\frac{f1}{f2} \equiv \frac{Q2}{Q1} \quad (9)$$

Where $f1$ and $Q1$ are the frequency and Q at one frequency, and $f2$ and $Q2$ are at the second, different frequency.

For example, if an 80-meter pi network has a Q of 12 at 4.0 MHz, what is the Q at 3.5 MHz?

$$\frac{4.0}{3.5} = \frac{Q2}{12} \quad Q2 = 13.7$$

Although the actual loaded Q is somewhat dependent upon the value of plate load impedance used in the circuit, this approximation is accurate within 1 per cent. In the above example, with a plate load impedance of 3000 ohms, $Q2$ would actually be 13.84.

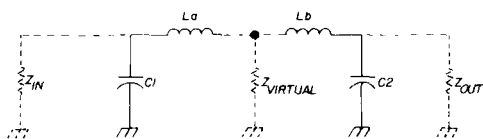

fig. 6. Pi network is basically two L networks in tandem.

Since the Q of the network goes up as the frequency goes down, it's a good idea to design the pi network for the highest frequency that is to be used.² With this approach, when the same inductor is used at lower frequencies within an amateur band, Q increases somewhat, improving harmonic attenuation.

Table 2 shows how Q varies as a pi network is retuned to a different frequency (same inductor). Table 2A shows a pi network designed for 4.0 MHz which is retuned to 3.5 MHz; Q increases from 12 at 4.0 MHz to 13.8 at 3.5 MHz. The values of the tuning and loading capacitors are shown for comparison.

Table 2B shows the case where a pi network is designed for 3.5 MHz with a Q of 12 and retuned to 4.0 MHz (same inductor). The Q drops to 10.4, well below the selected minimum of 12.

network efficiency

As the loaded Q of a network is increased, efficiency goes down because of higher circulating currents and higher losses in the components. Approximate efficiency is given by

$$\text{efficiency} = 100 \left(1 - \frac{Q_o}{Q_u} \right) \quad (10)$$

where Q_o is the loaded circuit Q and Q_u is the unloaded component Q . The graph in fig. 8 shows that efficiency is a linear function of loaded Q . For minimum loss, the loaded Q should be as low as convenient, while still providing adequate harmonic attenuation. This figure has arbitrarily been chosen as 12.

When the pi network is designed, the minimum Q of 12 can only be obtained at the upper frequency of

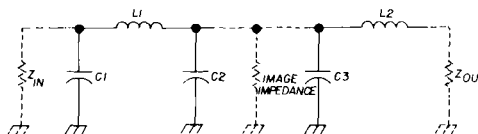

fig. 7. In the pi-L network a second L network is added to the basic pi network. Capacitors C2 and C3 are combined into one capacitor in a practical circuit, as shown in fig. 4.

each amateur band, and then only at the maximum input power level. For other frequencies or lower input powers, the loaded Q is higher than 12.

pi network design

Usually, when you are trying to design a pi network for your transmitter or linear amplifier, you must refer to graphs shown in reference books such as the ARRL "Radio Amateur's Handbook."³ These graphs are often somewhat confusing because you must first determine the plate load impedance, select a value of Q and then find the reactance of each of the components. Then you must locate yet another graph to convert these reactance values into actual values of inductance and capacitance.

Few of these charts and graphs are extended above plate load impedances of 5000 ohms, and most give vague reference to the fact that if the plate load impedance is greater than about 5000 ohms, the Q should be increased.

The charts in table 3 and table 4 are computer derived and offer all the required information to build

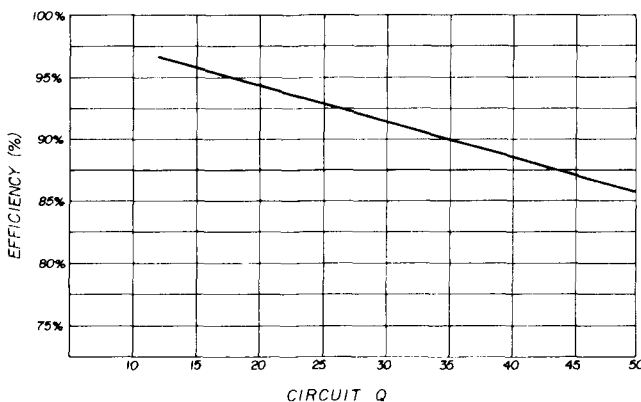

fig. 8. Efficiency of a network is inversely proportional to the loaded Q of the network.

table 1. Plate load impedances for different input power levels and different operating voltages and currents.

input power (W)	volts	mA	plate impedance (ohms)
1000	2000	500	2546
2000	2000	1000	1273
2500	2000	1250	1019
1000	2500	400	3979
2000	2500	800	1989
2500	2500	1000	1592
1000	2800	357	4991
2000	2800	714	2496
2500	2800	893	1996
1000	3300	303	6933
2000	3300	606	3466
2500	3300	758	2773
1000	4000	250	10186
2000	4000	500	5093
2500	4000	625	4074
1000	5000	200	15915
2000	5000	400	7958
2500	5000	500	6366
1000	6000	167	22918
2000	6000	333	11459
2500	6000	417	9167

a practical pi network. The pi networks in **table 3** for plate load impedances above 5000 ohms have increasing Q so that the transformation ratio never exceeds the 70 per cent maximum. In addition, the inductors chosen for each of the designs are calculated for the highest frequency in the band.

The Q of the network at the highest frequency is 12 except when the plate load impedance is greater than 5075 ohms. The chart shows the capacitance values required to resonate the network to the lowest frequency in the band (maximum capacitance), as well as the operating Q at that frequency. In **table 4**, the image impedance (R_3) at the lower frequency is also given.

You will notice that the Q of the pi-L network does not go up as fast when frequency is lowered as it does with the pi network. Also, the Q remains the same for the pi-L for higher plate loads.

In both **table 3** and **table 4** the values for ten meters are for 29.7 MHz, the highest frequency in the band. This is because you need to know minimum capacitance values to reach this frequency in a five-band transmitter.

effect of swr

A standing-wave ratio of 4:1 will affect the capacitance required at C1 by ± 10 per cent and at C2 by ± 25 per cent. If the swr is caused by capacitive reactance, the tuning and loading capacitors are on the

smaller side, and if the swr is the result of inductive reactance, the loading and tuning capacitors must be larger. Keep this in mind when selecting component values for a transmitter so you will be able to compensate for an antenna that is not exactly matched to your transmission line.

ssb and CW operation

Table 1 shows that for a given plate supply voltage, the plate load impedance is inversely proportional to the input power level. That is, 1000 watts at 2800 volts represents 5000 ohms, while 2 kW at the same supply voltage is 2500 ohms. Pi network values for a Q of 12 for each of these impedances are shown below (capacitance in pF, inductance in μ H):

f	R1	C1	L1	C2	Q
4.0 MHz	2500	191	9.18	1097	12.0
4.0 MHz	5000	95	17.38	534	12.0

Note that the required inductance values are quite different.

As an example of what you may expect under actual operating conditions, consider the 2-kW design above (9.18 μ H inductor). At 3.5 MHz with 2 kW input, C1 is 252 pF, C2 is 1536 pF, and Q is 13.8; not too bad. However, if the input power is reduced to 1000 watts at 3.5 MHz, C1 is 246 pF, C2 is 2287 pF, and Q reaches 27.0, increasing the circulating currents and heat losses in the network.

These figures point out the problems you can run into when you use the same operating voltage and same inductor at different power levels. Fortunately, there are several things which the designer can do to minimize these problems.

variable inductors

There are various variable rotary inductors available on the market which allow the operator to select the proper inductance for 1000 watts CW at the bottom of a band as well as 2000 watts PEP ssb at the top. When compared to fixed inductors, these variable units are fairly expensive, and require a turns counter, further increasing cost. However, they are available in various inductance and current-carrying abilities, so they encompass practically any design requirement. Also, using a variable inductor eliminates the need for a bandswitch.

bandswitch

The primary purpose of the bandswitch is to change the tap on the tank-circuit inductor to one better suited for the band in use. However, there are several other important functions for the bandswitch:

1. Used to switch input networks to match the 50-ohm output of the exciter.

2. Changes taps on the second inductor in a pi-L network.

3. Sometimes used to switch in additional tuning/loading capacitance on the 80-meter band so smaller variable capacitors may be used in the circuit.

Since you may wish to use a bandswitch in your power amplifier because of these additional uses, the variable inductor may lose some of its appeal.

In a novel approach to this problem a ten-position bandswitch has been used in one design to select different amounts of inductance for the CW and ssb ends of the band.⁴ However, the additional switch

have ample drive on CW if they are able to push the final to 2000 watts PEP on ssb.

power supply voltage

Since, as I just mentioned, most exciters have more than ample drive for 1000-watts input on CW if they are capable of driving the final to 2000-watts PEP on ssb, it's desirable to include some sort of automatic swamping so the exciter can be run in a normal manner for both ssb and CW. Lowering the plate supply voltage on the final-amplifier tubes decreases the plate load impedance required for a given input power level, therefore requiring more drive to reach this input power level.

table 2. Variations in Q as the resonant frequency of the pi network is changed (same inductor).

	frequency	plate impedance (ohms)	load impedance (ohms)	C1 (pF)	L1 (μ H)	C2 (pF)	Q
A. Decreasing frequency	4.0 MHz	2500	50	191	9.18	1097	12.0
	3.5 MHz	2500	50	252	9.18	1536	13.8
B. Increasing frequency	3.5 MHz	2500	50	218	10.49	1254	12.0
	4.0 MHz	2500	50	165	10.49	863	10.4

leads and the large number of inductor taps make this approach seem impractical for the typical home builder.

Table 5 compares the performance of 1000- and 2000-watt transmitters, as well as a 2000-watt transmitter run at 1000 watts input. In the latter case some additional losses are evident, but they're hardly large enough to cause much excitement. The same comparison shows that the 2-kW transmitter with a Q of 12 at 4 MHz, has a Q of 16.2 at 3.0 MHz. However, considerably more capacitance is required at C1 and C2. The pi-L network will alleviate this problem to some extent, as the Q of the pi-L does not increase as rapidly as frequency is lowered as it does with the straight pi network.

Since the 80-meter band is proportionally wider than any other high-frequency amateur band, there is some merit in using an extra bandswitch position for 80 meters.⁵ While I have shown previously that this is not required, it would be beneficial because you could select the 75-meter inductor for 4 MHz and 2-kW input, with the 80-meter inductor chosen for 3.7 MHz and 1-kW input.

The primary advantage in such an arrangement would be the ability to add a second input network to match the exciter. Since the input networks have low Q (typically 2 to 3), they are quite broadband and are usually set to a frequency in the middle of the band. However, it would be literally impossible for the same input network to work equally well on both 3.5 and 4.0 MHz, so it would be desirable to have one for each end of the band. From a practical standpoint, this might not be necessary because most operators

For example, if it takes 70 watts drive with 3000 volts on the plate to reach 2000-watts input, then, depending upon the tubes used, it would take 70 to 80 watts drive to reach 1000-watts input with a substantially lower plate supply voltage. At the same time, the voltage-current relationship has changed, lowering the plate load impedance to something much closer to that which would give a Q of 12 with the same inductor.

Also, the plate voltage must be lowered to retain the same Q with the same inductor at the same operating frequency. This voltage reduction can be determined from

$$E2 = 0.71 (E1) \quad (11)$$

where $E1$ is the original plate voltage for 2000-watts input and $E2$ is the lowered plate voltage for 1000-watts input. For example, a plate supply of 2800 volts for 2000-watts input must be changed to 2000 volts for 1000-watts input at the same operating frequency and circuit Q . Actually, on 3.5 MHz, this would be perhaps 1800 to 1900 volts to provide a Q of 12 at 3.5 MHz (1000 watts input) using a 2-kW transmitter designed for a Q of 12 at 4.0 MHz. However, it is unlikely that you could get 1000-watts input at this plate voltage, even with 100 watts drive on a cathode-driven grounded-grid amplifier.

tuning capacitance

Table 3 and table 4 show that the C1 tuning capacitance becomes quite small on 10 and 15 meters as the plate load impedance is raised. A typical 2000-watt transmitter might use 2800 volts on the plate,

table 3A. Pi network component values for matching a 50-ohm antenna load. Values have been chosen for a Q of 12 at the top edge of each amateur band. For plate load impedances greater than 5000 ohms, the Q of the network has been adjusted upward to compensate for the maximum transformation ratio, as discussed in the text. R1 is the plate load impedance.

R1 OHMS	F MHZ	C1 PF	L1 UH	C2 PF	R2 OHMS	Q QUAL.	R1 OHMS	F MHZ	C1 PF	L1 UH	C2 PF	R2 OHMS	Q QUAL.	R1 OHMS	F MHZ	C1 PF	L1 UH	C2 PF	R2 OHMS	Q QUAL.
200	3.5	3147	0.98	6244	50	13.8	1000	3.5	457	5.38	2295	50	13.8	7000	3.5	106	20.63	862	50	16.3
200	7.0	1427	0.54	2827	50	12.6	1000	7.0	204	2.95	982	50	12.6	7000	7.0	48	11.28	341	50	14.8
200	14.0	701	0.27	1387	50	12.3	1000	14.0	100	1.50	480	50	12.3	7000	14.0	24	5.74	162	50	14.5
200	21.0	465	0.18	921	50	12.3	1000	21.0	66	1.01	319	50	12.3	7000	21.0	16	3.84	107	50	14.4
200	29.7	322	0.13	636	50	12.0	1000	29.7	46	0.73	219	50	12.0	7000	29.7	11	2.77	70	50	14.1
300	3.5	2098	1.38	5071	50	13.8	1500	3.5	420	5.73	2117	50	13.8	7500	3.5	102	21.31	862	50	16.8
300	7.0	952	0.76	2294	50	12.6	1500	7.0	190	3.14	942	50	12.6	7500	7.0	46	11.66	341	50	15.3
300	14.0	467	0.39	1125	50	12.3	1500	14.0	93	1.60	460	50	12.3	7500	14.0	23	5.93	162	50	15.0
300	21.0	310	0.26	747	50	12.3	1500	21.0	62	1.07	305	50	12.3	7500	21.0	15	3.97	107	50	14.9
300	29.7	214	0.19	516	50	12.0	1500	29.7	43	0.77	210	50	12.0	7500	29.7	10	2.86	70	50	14.6
400	3.5	1573	1.76	4368	50	13.8	2000	3.5	315	7.46	1776	50	13.8	8000	3.5	99	21.98	862	50	17.4
400	7.0	714	0.97	1975	50	12.6	2000	7.0	143	4.09	783	50	12.6	8000	7.0	45	12.02	341	50	15.8
400	14.0	350	0.49	968	50	12.3	2000	14.0	70	2.08	382	50	12.3	8000	14.0	22	6.11	162	50	15.5
400	21.0	233	0.33	643	50	12.3	2000	21.0	47	1.39	253	50	12.3	8000	21.0	15	4.09	107	50	15.4
400	29.7	161	0.24	444	50	12.0	2000	29.7	32	1.01	174	50	12.0	8000	29.7	10	2.95	70	50	15.1
500	3.5	1259	2.14	3886	50	13.8	2500	3.5	252	9.17	1536	50	13.8	8500	3.5	96	22.62	862	50	17.9
500	7.0	571	1.18	1753	50	12.6	2500	7.0	114	5.03	670	50	12.6	8500	7.0	44	12.38	341	50	16.3
500	14.0	280	0.60	859	50	12.3	2500	14.0	56	2.56	326	50	12.3	8500	14.0	21	6.29	162	50	16.0
500	21.0	186	0.40	571	50	12.3	2500	21.0	37	1.71	216	50	12.3	8500	21.0	14	4.21	107	50	15.9
500	29.7	129	0.29	394	50	12.0	2500	29.7	26	1.24	148	50	12.0	8500	29.7	10	3.04	70	50	15.6
600	3.5	1049	2.51	3528	50	13.8	3000	3.5	210	10.86	1352	50	13.8	9000	3.5	93	23.24	862	50	18.5
600	7.0	476	1.38	1590	50	12.6	3000	7.0	95	5.95	583	50	12.6	9000	7.0	42	12.92	341	50	16.7
600	14.0	234	0.70	779	50	12.3	3000	14.0	47	3.03	283	50	12.3	9000	14.0	21	6.47	162	50	16.4
600	21.0	155	0.47	517	50	12.3	3000	21.0	31	2.02	187	50	12.3	9000	21.0	14	4.33	107	50	16.4
600	29.7	107	0.34	357	50	12.0	3000	29.7	21	1.46	128	50	12.0	9000	29.7	10	3.12	70	50	16.0
700	3.5	899	2.88	3248	50	13.8	3500	3.5	180	12.53	1203	50	13.8	9500	3.5	91	23.85	862	50	19.0
700	7.0	408	1.58	1462	50	12.6	3500	7.0	82	6.86	512	50	12.6	9500	7.0	41	13.06	341	50	17.2
700	14.0	200	0.81	716	50	12.3	3500	14.0	40	3.49	247	50	12.3	9500	14.0	20	6.64	162	50	16.9
700	21.0	133	0.54	475	50	12.3	3500	21.0	27	2.34	164	50	12.3	9500	21.0	13	4.44	107	50	16.8
700	29.7	92	0.39	328	50	12.0	3500	29.7	18	1.69	111	50	12.0	9500	29.7	9	3.21	70	50	16.4
800	3.5	787	3.24	3021	50	13.8	4000	3.5	157	14.19	1079	50	13.8	10000	3.5	88	24.44	862	50	19.5
800	7.0	357	1.78	1358	50	12.6	4000	7.0	71	7.77	451	50	12.6	10000	7.0	40	13.38	341	50	17.7
800	14.0	175	0.91	665	50	12.3	4000	14.0	35	3.95	217	50	12.3	10000	14.0	20	6.81	162	50	17.3
800	21.0	116	0.61	442	50	12.3	4000	21.0	23	2.64	144	50	12.3	10000	21.0	13	4.55	107	50	17.3
800	29.7	80	0.44	304	50	12.0	4000	29.7	16	1.91	97	50	12.0	10000	29.7	9	3.29	70	50	16.9
900	3.5	699	3.60	2832	50	13.8	4500	3.5	140	15.84	971	50	13.8	10500	3.5	86	25.02	862	50	19.9
900	7.0	317	1.98	1271	50	12.6	4500	7.0	63	8.66	397	50	12.6	10500	7.0	39	13.70	341	50	18.1
900	14.0	156	1.01	622	50	12.3	4500	14.0	31	4.40	190	50	12.3	10500	14.0	19	6.97	162	50	17.8
900	21.0	103	0.67	413	50	12.3	4500	21.0	21	2.95	126	50	12.3	10500	21.0	13	4.66	107	50	17.7
900	29.7	71	0.49	285	50	12.0	4500	29.7	14	2.13	84	50	12.0	10500	29.7	9	3.37	70	50	17.3
1000	3.5	629	3.96	2671	50	13.8	5000	3.5	126	17.48	875	50	13.8	11000	3.5	84	25.58	862	50	20.4
1000	7.0	285	2.18	1197	50	12.6	5000	7.0	57	9.55	348	50	12.6	11000	7.0	38	14.01	341	50	18.5
1000	14.0	140	1.11	586	50	12.3	5000	14.0	28	4.85	165	50	12.3	11000	14.0	19	7.13	162	50	18.2
1000	21.0	93	0.74	389	50	12.3	5000	21.0	19	3.25	109	50	12.3	11000	21.0	12	4.77	107	50	18.1
1000	29.7	64	0.54	268	50	12.0	5000	29.7	13	2.34	72	50	12.0	11000	29.7	9	3.44	70	50	17.7
1100	3.5	572	4.32	2532	50	13.8	5500	3.5	119	18.41	861	50	14.4	11500	3.5	83	26.13	862	50	20.9
1100	7.0	260	2.37	1135	50	12.6	5500	7.0	54	10.05	341	50	12.6	11500	7.0	37	14.32	341	50	18.9
1100	14.0	127	1.21	555	50	12.3	5500	14.0	27	5.11	162	50	12.3	11500	14.0	18	7.28	162	50	18.6
1100	21.0	85	0.81	368	50	12.3	5500	21.0	18	3.42	107	50	12.3	11500	21.0	12	4.87	107	50	18.5
1100	29.7	58	0.58	253	50	12.0	5500	29.7	12	2.47	70	50	12.0	11500	29.7	8	3.52	70	50	18.1
1200	3.5	524	4.67	2410	50	13.8	6000	3.5	114	19.18	862	50	15.1	12000	3.5	81	26.67	862	50	21.3
1200	7.0	238	2.57	1077	50	12.6	6000	7.0	52	10.48	341	50	13.7	12000	7.0	37	14.61	341	50	19.3
1200	14.0	117	1.31	527	50	12.3	6000	14.0	25	5.33	162	50	13.4	12000	14.0	18	7.43	162	50	19.0
1200	21.0	78	0.87	350	50	12.3	6000	21.0	17	3.56	107	50	13.4	12000	21.0	12	4.97	107	50	18.9
1200	29.7	54	0.63	241	50	12.0	6000	29.7	12	2.57	70	50	13.1	12000	29.7	8	3.59	70	50	18.5
1300	3.5	484	5.03	2302	50	13.8	6500	3.5	110	19.92	862	50	15.7							
1300	7.0	220	2.76	1027	50	12.6	6500	7.0	50	10.89	341	50	14.2							
1300	14.0	108	1.40	502	50	12.3	6500	14.0	24	5.54	162	50	14.0							
1300	21.0	72	0.94	333	50	12.3	6500	21.0	16	3.70	107	50	13.9							
1300	29.7	49	0.68	229	50	12.0	6500	29.7	11	2.67	70	50	13.6							

providing a plate load impedance of approximately 2500 ohms. This transmitter would require only 26 pF tuning capacitance to reach the top end of the 10-meter band.

Unfortunately, most modern rf power tubes designed for the 2000-watt level have output capacitances on the order of 10 pF — this leaves about 16 pF for tuning, including stray circuit capacitance.

If you study the various air-variable capacitors available you will find that it is virtually impossible to find a variable capacitor that will provide the necessary spacing for this operating voltage as well as tune the capacitance range needed for both 10 and 80 meters. Also, you must keep in mind that ± 10 per cent leeway should be provided to compensate for any swr on the transmission line.

As the plate load impedance increases, the situa-

tion becomes even more acute. A 1000-watt transmitter with a plate supply of 2800 volts has a plate load impedance of 5000 ohms — on ten meters this means the tuning capacitor C1 is a total of 13 pF. In this case you would probably have to delete C1 entirely from the circuit and let the capacitance of the power tube supply the necessary tuning capacitance. However, this is not practical.

Fortunately, there are several things you can do to help alleviate this situation. You can use a smaller capacitor and add fixed capacitance on 40 and 80 meters, or use two variable capacitors, switching in the larger one on the lower bands. The vacuum capacitor is another possibility because of its low minimum capacitance, often as low as 3 pF. You can also blunder ahead and use a too-large capacitor, allowing the Q to be higher than normal.

table 3B. Pi-network component values for use within the 160-meter amateur band. Values were determined as in table 3A.

R1 OHMS	F MHZ	C1 PF	L1 UH	C2 PF	R2 OHMS	Q QUAL.	R1 OHMS	F MHZ	C1 PF	L1 UH	C2 PF	R2 OHMS	Q QUAL.	R1 OHMS	F MHZ	C1 PF	L1 UH	C2 PF	R2 OHMS	Q QUAL.
1000	1.8	1187	7.94	5019	50	13.4	4750	1.8	250	33.33	1684	50	13.4	8500	1.8	181	45.26	1567	50	17.4
1000	1.9	1062	7.95	4459	50	12.7	4750	1.9	224	33.26	1403	50	12.7	8500	1.9	162	45.21	1290	50	16.4
1000	2.0	955	7.96	3979	50	12.0	4750	2.0	201	33.17	1155	50	12.0	8500	2.0	146	45.14	1042	50	15.6
1250	1.8	949	9.71	4419	50	13.4	5000	1.8	237	34.96	1593	50	13.4	8750	1.8	178	45.89	1567	50	17.6
1250	1.9	849	9.72	3917	50	12.7	5000	1.9	212	34.87	1315	50	12.7	8750	1.9	160	45.84	1290	50	16.7
1250	2.0	764	9.74	3487	50	12.0	5000	2.0	191	34.77	1058	50	12.0	8750	2.0	144	45.77	1042	50	15.8
1500	1.8	791	11.47	3969	50	13.4	5250	1.8	230	36.01	1566	50	13.7	9000	1.8	176	46.51	1567	50	17.9
1500	1.9	708	11.48	3510	50	12.7	5250	1.9	206	35.93	1290	50	12.9	9000	1.9	157	46.47	1290	50	16.9
1500	2.0	637	11.49	3116	50	12.0	5250	2.0	185	35.82	1042	50	12.2	9000	2.0	142	46.40	1042	50	16.0
1750	1.8	678	13.21	3613	50	13.4	5500	1.8	225	36.81	1565	50	14.0	9250	1.8	173	47.13	1567	50	18.1
1750	1.9	607	13.22	3177	50	12.7	5500	1.9	201	36.73	1290	50	13.2	9250	1.9	155	47.08	1290	50	17.1
1750	2.0	546	13.23	2822	50	12.0	5500	2.0	181	36.63	1042	50	12.5	9250	2.0	140	47.02	1042	50	16.2
2000	1.8	593	14.94	3322	50	13.4	5750	1.8	224	37.59	1567	50	14.3	9500	1.8	171	47.73	1567	50	18.4
2000	1.9	531	14.94	2922	50	12.7	5750	1.9	197	37.52	1290	50	13.5	9500	1.9	153	47.69	1290	50	17.4
2000	2.0	477	14.95	2579	50	12.0	5750	2.0	177	37.41	1042	50	12.8	9500	2.0	138	47.63	1042	50	16.4
2250	1.8	527	16.65	3076	50	13.4	6000	1.8	215	38.36	1567	50	14.6	9750	1.8	169	48.33	1567	50	18.6
2250	1.9	472	16.65	2697	50	12.7	6000	1.9	193	38.28	1290	50	13.8	9750	1.9	151	48.29	1290	50	17.6
2250	2.0	424	16.66	2373	50	12.0	6000	2.0	173	38.18	1042	50	13.1	9750	2.0	136	48.23	1042	50	16.7
2500	1.8	475	18.36	2864	50	13.4	6250	1.8	211	39.11	1567	50	14.9	10000	1.8	167	48.92	1568	50	18.9
2500	1.9	425	18.36	2504	50	12.7	6250	1.9	189	39.03	1290	50	14.1	10000	1.9	149	48.88	1290	50	17.8
2500	2.0	382	18.36	2194	50	12.0	6250	2.0	170	38.94	1042	50	13.3	10000	2.0	134	48.82	1042	50	16.9
2750	1.8	432	20.05	2678	50	13.4	6500	1.8	207	39.84	1567	50	15.2	10250	1.8	165	49.50	1568	50	19.1
2750	1.9	386	20.05	2333	50	12.7	6500	1.9	185	39.77	1290	50	14.4	10250	1.9	147	49.46	1290	50	18.0
2750	2.0	347	20.04	2036	50	12.0	6500	2.0	166	39.68	1042	50	13.6	10250	2.0	133	49.41	1042	50	17.1
3000	1.8	396	21.74	2513	50	13.4	6750	1.8	203	40.56	1567	50	15.5	10500	1.8	163	50.07	1568	50	19.3
3000	1.9	354	21.73	2181	50	12.7	6750	1.9	182	40.49	1290	50	14.6	10500	1.9	146	50.04	1290	50	18.3
3000	2.0	318	21.72	1894	50	12.0	6750	2.0	163	40.40	1042	50	13.9	10500	2.0	131	49.98	1042	50	17.3
3250	1.8	365	23.41	2364	50	13.4	7000	1.8	199	41.27	1567	50	15.8	10750	1.8	161	50.64	1568	50	19.6
3250	1.9	327	23.40	2043	50	12.7	7000	1.9	178	41.20	1290	50	14.9	10750	1.9	144	50.61	1290	50	18.5
3250	2.0	294	23.38	1766	50	12.0	7000	2.0	160	41.11	1042	50	14.1	10750	2.0	130	50.56	1042	50	17.5
3500	1.8	339	25.08	2228	50	13.4	7250	1.8	196	41.96	1567	50	16.1	11000	1.8	159	51.20	1568	50	19.8
3500	1.9	303	25.06	1917	50	12.7	7250	1.9	175	41.90	1290	50	15.2	11000	1.9	142	51.17	1290	50	18.7
3500	2.0	273	25.04	1647	50	12.0	7250	2.0	158	41.81	1042	50	14.4	11000	2.0	128	51.12	1042	50	17.7
3750	1.8	316	26.75	2104	50	13.4	7500	1.8	193	42.64	1567	50	16.3	11250	1.8	157	51.76	1568	50	20.0
3750	1.9	283	26.72	1801	50	12.7	7500	1.9	172	42.58	1290	50	15.4	11250	1.9	141	51.73	1290	50	18.9
3750	2.0	255	26.68	1538	50	12.0	7500	2.0	155	42.50	1042	50	14.6	11250	2.0	127	51.68	1042	50	17.9
4000	1.8	297	28.40	1938	50	13.4	7750	1.8	189	43.31	1567	50	16.6	11500	1.8	156	52.30	1568	50	20.2
4000	1.9	265	28.37	1693	50	12.7	7750	1.9	169	43.25	1290	50	15.7	11500	1.9	139	52.28	1290	50	19.1
4000	2.0	239	28.32	1435	50	12.0	7750	2.0	152	43.17	1042	50	14.8	11500	2.0	125	52.23	1042	50	18.1
4250	1.8	279	30.05	1881	50	13.4	8000	1.8	186	43.97	1567	50	16.9	11750	1.8	154	52.85	1568	50	20.5
4250	1.9	250	30.00	1591	50	12.7	8000	1.9	167	43.92	1290	50	15.9	11750	1.9	138	52.82	1290	50	19.3
4250	2.0	225	29.95	1337	50	12.0	8000	2.0	150	43.84	1042	50	15.1	11750	2.0	124	52.78	1042	50	18.3
4500	1.8	264	31.69	1779	50	13.4	8250	1.8	184	44.62	1567	50	17.1	12000	1.8	152	53.38	1568	50	20.7
4500	1.9	236	31.64	1495	50	12.7	8250	1.9	164	44.57	1290	50	16.2	12000	1.9	136	53.36	1290	50	19.5
4500	2.0	212	31.57	1244	50	12.0	8250	2.0	148	44.49	1042	50	15.3	12000	2.0	123	53.32	1042	50	18.5

Oddly enough, each of these different techniques is currently being used in commercial amateur-band power amplifiers. The vacuum variable provides the best answer to this problem, but it is also the most expensive (by a wide margin). However, the vacuum variable has many advantages worth considering if you are more interested in performance than in total cost.

From table 6 you can see that the *Q* on ten meters goes up quite rapidly if too much capacitance is used at C1. One currently available commercial amplifier uses 2800 volts at 2-kW input (plate impedance, 2500 ohms). For ten meters this calls for an input capacitor of about 15 pF, after the output capacitance of the tubes has been subtracted. However, this amplifier uses two 20-150 pF capacitors in parallel which are tuned in tandem with a geared arrangement. Thus, their minimum capacitance is about 40 pF, plus 10 pF added by the power tubes, providing a minimum input capacitance of more than 50 pF without any allowance for strays.

Table 6 shows that this gives a minimum *Q* of 24.0 at the top end of the ten-meter band (around 25.5 at the bottom end). If the amplifier were used at 1000-

watts input, the *Q* would be nearly 48 at the top band edge and over 50 at the bottom!

This amplifier would obviously lose substantial power output in the form of heat in the tank inductor, and proper tuning would be very critical. It would also have to be retuned more often as frequency was changed.

This design is what I call the *blunder-ahead* method. In my mind, it would have been relatively simple for the manufacturer to use only one of the two tuning capacitors on 10, 15, and 20 meters, switching in the second tuning capacitor on 40 and 80.

Another manufacturer does precisely this. He uses a dual-section capacitor — half is used for the three upper bands and the other half is added in parallel on 40 and 80 meters. This provides normal *Q* for 2000-watts input on 10 meters. It still gives *Q* in excess of 20 with 1000-watts input, but that's really not too bad. This tuning system gives more than twice the *vernier* of the other system since the maximum capacitance on 20 meters, for example, is 120 pF. On the previous amplifier there is 300 pF available, even on 20 meters. The unit with the lower capacitance is far easier to tune on the upper three bands.

table 4A. Pi-L network component values for matching a 50-ohm antenna load. Values have been chosen for a Q of 12 at the top edge of each amateur band. The image impedance (R3) has been chosen to provide a balanced transformation in the T section of the pi-L network. R1 is the plate load impedance.

R1 OHMS	F MHZ	C1 PF	L1 UH	C2 PF	L2 UH	R2 OHMS	R3 OHMS	'Q' QUAL	R1 OHMS	F MHZ	C1 PF	L1 UH	C2 PF	L2 UH	R2 OHMS	R3 OHMS	'Q' QUAL
500	3.5	1219	2.86	2118	4.45	241	50	13.4	4500	3.5	135	18.53	924	4.45	241	50	13.4
500	7.0	565	1.59	927	2.44	288	50	12.4	4500	7.0	63	10.12	413	2.44	288	50	12.4
500	14.0	277	0.81	451	1.24	288	50	12.2	4500	14.0	31	5.17	202	1.24	288	50	12.2
500	21.0	185	0.54	300	0.83	288	50	12.2	4500	21.0	21	3.44	135	0.83	288	50	12.2
500	29.7	129	0.39	206	0.60	300	50	12.0	4500	29.7	14	2.49	93	0.60	300	50	12.0
600	3.5	1015	3.30	1963	4.45	241	50	13.4	5000	3.5	122	20.37	892	4.45	241	50	13.4
600	7.0	471	1.83	861	2.44	288	50	12.4	5000	7.0	56	11.13	399	2.44	288	50	12.4
600	14.0	231	0.94	419	1.24	288	50	12.2	5000	14.0	28	5.68	195	1.24	288	50	12.2
600	21.0	154	0.63	279	0.83	288	50	12.2	5000	21.0	18	3.78	136	0.83	288	50	12.2
600	29.7	107	0.45	191	0.60	300	50	12.0	5000	29.7	13	2.73	90	0.60	300	50	12.0
700	3.5	870	3.74	1843	4.45	241	50	13.4	5500	3.5	111	22.21	864	4.45	241	50	13.4
700	7.0	403	2.07	809	2.44	288	50	12.4	5500	7.0	51	12.12	386	2.44	288	50	12.4
700	14.0	198	1.06	394	1.24	288	50	12.2	5500	14.0	25	6.18	189	1.24	288	50	12.2
700	21.0	132	0.71	262	0.83	288	50	12.2	5500	21.0	17	4.12	126	0.83	288	50	12.2
700	29.7	92	0.51	180	0.60	300	50	12.0	5500	29.7	12	2.97	87	0.60	300	50	12.0
800	3.5	762	4.17	1746	4.45	241	50	13.4	6000	3.5	102	24.03	840	4.45	241	50	13.4
800	7.0	353	2.31	767	2.44	288	50	12.4	6000	7.0	47	13.11	377	2.44	288	50	12.4
800	14.0	175	1.18	373	1.24	288	50	12.2	6000	14.0	23	6.69	184	1.24	288	50	12.2
800	21.0	116	0.79	249	0.83	288	50	12.2	6000	21.0	15	4.46	123	0.83	288	50	12.2
800	29.7	80	0.57	170	0.60	300	50	12.0	6000	29.7	11	3.22	85	0.60	300	50	12.0
900	3.5	677	4.60	1666	4.45	241	50	13.4	6500	3.5	94	25.85	819	4.45	241	50	13.4
900	7.0	314	2.54	733	2.44	288	50	12.4	6500	7.0	43	14.09	368	2.44	288	50	12.4
900	14.0	154	1.30	357	1.24	288	50	12.2	6500	14.0	21	7.19	180	1.24	288	50	12.2
900	21.0	103	0.87	238	0.83	288	50	12.2	6500	21.0	14	4.79	120	0.83	288	50	12.2
900	29.7	71	0.63	163	0.60	300	50	12.0	6500	29.7	10	3.46	83	0.60	300	50	12.0
1000	3.5	609	5.02	1598	4.45	241	50	13.4	7000	3.5	87	27.65	799	4.45	241	50	13.4
1000	7.0	282	2.77	703	2.44	288	50	12.4	7000	7.0	40	15.07	360	2.44	288	50	12.4
1000	14.0	139	1.42	342	1.24	288	50	12.2	7000	14.0	20	7.69	176	1.24	288	50	12.2
1000	21.0	92	0.95	228	0.83	288	50	12.2	7000	21.0	13	5.12	117	0.83	288	50	12.2
1000	29.7	64	0.68	156	0.60	300	50	12.0	7000	29.7	9	3.70	81	0.60	300	50	12.0
1100	3.5	554	5.43	1539	4.45	241	50	13.4	7500	3.5	81	29.45	782	4.45	241	50	13.4
1100	7.0	257	3.00	678	2.44	288	50	12.4	7500	7.0	38	16.05	352	2.44	288	50	12.4
1100	14.0	125	1.53	330	1.24	288	50	12.2	7500	14.0	18	8.18	172	1.24	288	50	12.2
1100	21.0	84	1.02	220	0.83	288	50	12.2	7500	21.0	12	5.45	115	0.83	288	50	12.2
1100	29.7	58	0.74	151	0.60	300	50	12.0	7500	29.7	9	3.93	79	0.60	300	50	12.0
1200	3.5	508	5.85	1488	4.45	241	50	13.4	8000	3.5	76	31.25	766	4.45	241	50	13.4
1200	7.0	235	3.23	656	2.44	288	50	12.4	8000	7.0	35	17.02	345	2.44	288	50	12.4
1200	14.0	116	1.65	320	1.24	288	50	12.2	8000	14.0	17	8.68	169	1.24	288	50	12.2
1200	21.0	77	1.10	213	0.83	288	50	12.2	8000	21.0	12	5.78	113	0.83	288	50	12.2
1200	29.7	54	0.80	146	0.60	300	50	12.0	8000	29.7	8	4.17	78	0.60	300	50	12.0
1300	3.5	469	6.25	1443	4.45	241	50	13.4	8500	3.5	72	33.03	751	4.45	241	50	13.4
1300	7.0	217	3.45	637	2.44	288	50	12.4	8500	7.0	33	17.99	339	2.44	288	50	12.4
1300	14.0	107	1.76	310	1.24	288	50	12.2	8500	14.0	16	9.17	166	1.24	288	50	12.2
1300	21.0	71	1.18	207	0.83	288	50	12.2	8500	21.0	11	6.11	111	0.83	288	50	12.2
1300	29.7	49	0.85	142	0.60	300	50	12.0	8500	29.7	8	4.41	76	0.60	300	50	12.0
1400	3.5	435	6.66	1403	4.45	241	50	13.4	9000	3.5	68	34.82	738	4.45	241	50	13.4
1400	7.0	202	3.67	619	2.44	288	50	12.4	9000	7.0	31	18.95	333	2.44	288	50	12.4
1400	14.0	99	1.88	302	1.24	288	50	12.2	9000	14.0	15	9.66	163	1.24	288	50	12.2
1400	21.0	66	1.25	201	0.83	288	50	12.2	9000	21.0	10	6.44	109	0.83	288	50	12.2
1400	29.7	46	0.90	138	0.60	300	50	12.0	9000	29.7	7	4.64	74	0.60	300	50	12.0
1500	3.5	406	7.06	1367	4.45	241	50	13.4	9500	3.5	64	36.59	725	4.45	241	50	13.4
1500	7.0	188	3.89	604	2.44	288	50	12.4	9500	7.0	30	19.91	328	2.44	288	50	12.4
1500	14.0	92	1.99	294	1.24	288	50	12.2	9500	14.0	15	10.15	160	1.24	288	50	12.2
1500	21.0	62	1.33	196	0.83	288	50	12.2	9500	21.0	10	6.77	107	0.83	288	50	12.2
1500	29.7	43	0.96	134	0.60	300	50	12.0	9500	29.7	7	4.88	74	0.60	300	50	12.0
2000	3.5	305	9.05	1228	4.45	241	50	13.4	10000	3.5	61	38.36	714	4.45	241	50	13.4
2000	7.0	141	4.97	544	2.44	288	50	12.4	10000	7.0	28	20.87	323	2.44	288	50	12.4
2000	14.0	69	2.54	265	1.24	288	50	12.2	10000	14.0	14	10.64	158	1.24	288	50	12.2
2000	21.0	46	1.69	177	0.83	288	50	12.2	10000	21.0	9	7.09	105	0.83	288	50	12.2
2000	29.7	32	1.22	121	0.60	300	50	12.0	10000	29.7	6	5.11	73	0.60	300	50	12.0
2500	3.5	244	10.99	1132	4.45	241	50	13.4	10500	3.5	58	40.13	703	4.45	241	50	13.4
2500	7.0	113	6.03	503	2.44	288	50	12.4	10500	7.0	27	21.82	318	2.44	288	50	12.4
2500	14.0	55	3.08	245	1.24	288	50	12.2	10500	14.0	13	11.12	156	1.24	288	50	12.2
2500	21.0	37	2.05	164	0.83	288	50	12.2	10500	21.0	9	7.42	104	0.83	288	50	12.2
2500	29.7	26	1.48	112	0.60	300	50	12.0	10500	29.7	6	5.34	72	0.60	300	50	12.0
3000	3.5	203	12.90	1062	4.45	241	50	13.4	11000	3.5	55	41.89	693	4.45	241	50	13.4
3000	7.0	94	7.07	472	2.44	288	50	12.4	11000	7.0	26	22.78	314	2.44	288	50	12.4
3000	14.0	46	3.61	231	1.24	288	50	12.2	11000	14.0	13	11.61	154	1.24	288	50	12.2
3000	21.0	31	2.41	154	0.83	288	50	12.2	11000	21.0	8	7.74	102	0.83	288	50	12.2
3000	29.7	21	1.74	106	0.60	300	50	12.0	11000	29.7	6	5.58	71	0.60	300	50	12.0
3500	3.5	174	14.79	1006	4.45	241	50	13.4	11500	3.5	53	43.65	683	4.45	241	50	13.4
3500	7.0	81	8.10	449	2.44	288	50	12.4	11500	7.0	25	23.73	310	2.44	288	50	12.4
3500	14.0	40	4.13	219	1.24	288	50	12.2	11500	14.0	12	12.09	152	1.24	288	50	12.2
3500	21.0	26	2.76	146	0.83	288	50	12.2	11500	21.0	8	8.06	101	0.83	288	50	12.2
3500	29.7	18	1.99	100	0.60	300	50	12.0	11500	29.7	6	5.81	70	0.60	300	50	12.0
4000	3.5	152	16.67	961	4.45	241	50	13.4	12000	3.5	51	45.40	674	4.45	241	50	13.4
4000	7.0	71	9.12	429	2.44	288	50	12.4	12000	7.0	24	24.67	306	2.44	288	50	12.4
4000	14.0	35	4.65	210	1.24	288	50	12.2	12000								

table 4B. Pi-L network component values for the 160-meter amateur band. Values were determined as in table 4A.

R1 OHMS	F MHZ	C1 PF	L1 UH	C2 PF	L2 UH	R2 OHMS	R3 OHMS	'Q' QUAL	R1 OHMS	F MHZ	C1 PF	L1 UH	C2 PF	L2 UH	R2 OHMS	R3 OHMS	'Q' QUAL
1000	1.8	1155	10.08	2995	8.90	252	50	13.1	7500	1.8	154	58.89	1471	8.90	252	50	13.1
1000	1.9	1047	10.12	2626	8.90	275	50	12.5	7500	1.9	140	58.65	1311	8.90	275	50	12.5
1000	2.0	955	10.16	2322	8.90	300	50	12.0	7500	2.0	127	58.41	1174	8.90	300	50	12.0
1250	1.8	924	12.14	2739	8.90	252	50	13.1	7750	1.8	149	60.69	1456	8.90	252	50	13.1
1250	1.9	838	12.18	2412	8.90	275	50	12.5	7750	1.9	135	60.43	1298	8.90	275	50	12.5
1250	2.0	764	12.22	2135	8.90	300	50	12.0	7750	2.0	123	60.17	1163	8.90	300	50	12.0
1500	1.8	770	14.17	2556	8.90	252	50	13.1	8000	1.8	144	62.47	1442	8.90	252	50	13.1
1500	1.9	698	14.20	2253	8.90	275	50	12.5	8000	1.9	131	62.20	1285	8.90	275	50	12.5
1500	2.0	637	14.23	1997	8.90	300	50	12.0	8000	2.0	119	61.93	1152	8.90	300	50	12.0
1750	1.8	660	16.17	2413	8.90	252	50	13.1	8250	1.8	140	64.26	1428	8.90	252	50	13.1
1750	1.9	590	16.19	2129	8.90	275	50	12.5	8250	1.9	127	63.97	1273	8.90	275	50	12.5
1750	2.0	546	16.22	1889	8.90	300	50	12.0	8250	2.0	116	63.69	1141	8.90	300	50	12.0
2000	1.8	578	18.14	2298	8.90	252	50	13.1	8500	1.8	136	66.04	1414	8.90	252	50	13.1
2000	1.9	524	18.15	2029	8.90	275	50	12.5	8500	1.9	123	65.74	1262	8.90	275	50	12.5
2000	2.0	477	18.17	1801	8.90	300	50	12.0	8500	2.0	112	65.44	1131	8.90	300	50	12.0
2250	1.8	514	20.09	2203	8.90	252	50	13.1	8750	1.8	132	67.82	1402	8.90	252	50	13.1
2250	1.9	466	20.10	1946	8.90	275	50	12.5	8750	1.9	120	67.50	1251	8.90	275	50	12.5
2250	2.0	424	20.11	1729	8.90	300	50	12.0	8750	2.0	109	67.19	1122	8.90	300	50	12.0
2500	1.8	462	22.02	2121	8.90	252	50	13.1	9000	1.8	128	69.59	1390	8.90	252	50	13.1
2500	1.9	419	22.02	1876	8.90	275	50	12.5	9000	1.9	116	69.27	1240	8.90	275	50	12.5
2500	2.0	382	22.02	1667	8.90	300	50	12.0	9000	2.0	106	68.94	1112	8.90	300	50	12.0
2750	1.8	420	23.94	2051	8.90	252	50	13.1	9250	1.8	125	71.37	1378	8.90	252	50	13.1
2750	1.9	381	23.93	1815	8.90	275	50	12.5	9250	1.9	113	71.02	1220	8.90	275	50	12.5
2750	2.0	347	23.92	1614	8.90	300	50	12.0	9250	2.0	103	70.69	1104	8.90	300	50	12.0
3000	1.8	385	25.85	1990	8.90	252	50	13.1	9500	1.8	122	73.14	1366	8.90	252	50	13.1
3000	1.9	349	25.83	1762	8.90	275	50	12.5	9500	1.9	110	72.78	1209	8.90	275	50	12.5
3000	2.0	318	25.81	1568	8.90	300	50	12.0	9500	2.0	101	72.43	1095	8.90	300	50	12.0
3250	1.8	356	27.74	1936	8.90	252	50	13.1	9750	1.8	119	74.91	1355	8.90	252	50	13.1
3250	1.9	322	27.71	1715	8.90	275	50	12.5	9750	1.9	107	74.53	1211	8.90	275	50	12.5
3250	2.0	294	27.68	1527	8.90	300	50	12.0	9750	2.0	98	74.17	1087	8.90	300	50	12.0
3500	1.8	330	29.62	1887	8.90	252	50	13.1	10000	1.8	116	76.67	1345	8.90	252	50	13.1
3500	1.9	299	29.58	1675	8.90	275	50	12.5	10000	1.9	105	76.28	1202	8.90	275	50	12.5
3500	2.0	273	29.54	1490	8.90	300	50	12.0	10000	2.0	95	75.90	1079	8.90	300	50	12.0
3750	1.8	308	31.50	1844	8.90	252	50	13.1	10250	1.8	113	78.43	1335	8.90	252	50	13.1
3750	1.9	279	31.45	1635	8.90	275	50	12.5	10250	1.9	102	78.03	1193	8.90	275	50	12.5
3750	2.0	255	31.40	1457	8.90	300	50	12.0	10250	2.0	93	77.64	1071	8.90	300	50	12.0
4000	1.8	289	33.37	1804	8.90	252	50	13.1	10500	1.8	110	80.19	1325	8.90	252	50	13.1
4000	1.9	262	33.30	1600	8.90	275	50	12.5	10500	1.9	100	79.78	1184	8.90	275	50	12.5
4000	2.0	239	33.24	1427	8.90	300	50	12.0	10500	2.0	91	79.37	1063	8.90	300	50	12.0
4250	1.8	272	35.23	1768	8.90	252	50	13.1	10750	1.8	107	81.95	1315	8.90	252	50	13.1
4250	1.9	246	35.15	1569	8.90	275	50	12.5	10750	1.9	97	81.52	1176	8.90	275	50	12.5
4250	2.0	225	35.08	1399	8.90	300	50	12.0	10750	2.0	89	81.09	1056	8.90	300	50	12.0
4500	1.8	257	37.08	1735	8.90	252	50	13.1	11000	1.8	105	83.71	1306	8.90	252	50	13.1
4500	1.9	233	36.99	1540	8.90	275	50	12.5	11000	1.9	95	83.26	1168	8.90	275	50	12.5
4500	2.0	212	36.91	1374	8.90	300	50	12.0	11000	2.0	87	82.82	1049	8.90	300	50	12.0
4750	1.8	243	38.92	1704	8.90	252	50	13.1	11250	1.8	103	85.46	1297	8.90	252	50	13.1
4750	1.9	221	38.83	1513	8.90	275	50	12.5	11250	1.9	93	85.00	1160	8.90	275	50	12.5
4750	2.0	201	38.73	1351	8.90	300	50	12.0	11250	2.0	85	84.54	1042	8.90	300	50	12.0
5000	1.8	231	40.76	1675	8.90	252	50	13.1	11500	1.8	100	87.21	1288	8.90	252	50	13.1
5000	1.9	209	40.65	1489	8.90	275	50	12.5	11500	1.9	91	86.73	1152	8.90	275	50	12.5
5000	2.0	191	40.54	1329	8.90	300	50	12.0	11500	2.0	83	86.26	1036	8.90	300	50	12.0
5250	1.8	220	42.60	1649	8.90	252	50	13.1	11750	1.8	98	88.96	1280	8.90	252	50	13.1
5250	1.9	200	42.47	1466	8.90	275	50	12.5	11750	1.9	89	88.47	1145	8.90	275	50	12.5
5250	2.0	182	42.35	1309	8.90	300	50	12.0	11750	2.0	81	87.98	1029	8.90	300	50	12.0
5500	1.8	210	44.43	1624	8.90	252	50	13.1	12000	1.8	96	90.71	1271	8.90	252	50	13.1
5500	1.9	190	44.29	1444	8.90	275	50	12.5	12000	1.9	87	90.20	1138	8.90	275	50	12.5
5500	2.0	174	44.16	1290	8.90	300	50	12.0	12000	2.0	80	89.70	1023	8.90	300	50	12.0
5750	1.8	201	46.25	1601	8.90	252	50	13.1									
5750	1.9	182	46.10	1424	8.90	275	50	12.5									
5750	2.0	166	45.95	1273	8.90	300	50	12.0									
6000	1.8	193	48.07	1579	8.90	252	50	13.1									
6000	1.9	175	47.91	1405	8.90	275	50	12.5									
6000	2.0	159	47.75	1256	8.90	300	50	12.0									
6250	1.8	185	49.88	1559	8.90	252	50	13.1									
6250	1.9	168	49.71	1387	8.90	275	50	12.5									
6250	2.0	153	49.53	1241	8.90	300	50	12.0									
6500	1.8	178	51.69	1539	8.90	252	50	13.1									
6500	1.9	161	51.50	1370	8.90	275	50	12.5									
6500	2.0	147	51.32	1226	8.90	300	50	12.0									
6750	1.8	171	53.50	1521	8.90	252	50	13.1									
6750	1.9	155	53.30	1354	8.90	275	50	12.5									
6750	2.0	141	53.10	1212	8.90	300	50	12.0									
7000	1.8	165	55.30	1503	8.90	252	50	13.1									
7000	1.9	150	55.09	1339	8.90	275	50	12.5									
7000	2.0	136	54.87	1199	8.90	300	50	12.0									
7250	1.8	159	57.10	1487	8.90	252	50	13.1									
7250	1.9	144	56.87	1325	8.90	275	50	12.5									
7250	2.0	132	56.64	1186	8.90	300	50	12.0									

	band	turns	approximate inductance
	80	11.000	4.43 μH
	40	7.125	2.43 μH
	20	4.5000	1.23 μH
	15	3.500	0.83 μH
	10	2.875	0.60 μH

A suitable coil for the L-network inductor consists of two inches (5cm) of Air-Dux 1606T [6 turns-per-inch, (2.5cm), no. 14 wire, 2" (2.5cm) diameter]. This inductor should be placed at right angles to the main pi inductor to avoid mutual inductance. In the following chart, 7.125 would be slightly over 7 full turns, 2.875 is slightly less than 3 full turns.

table 5. Comparisons between a 1-kW transmitter, a 2-kW transmitter, and a 2-kW transmitter operated at 1-kW input. A frequency of 4 MHz was used, but other frequencies from 3 to 30 MHz should produce comparable results. (These calculations are computer derived for comparative purposes and only approximate actual operating conditions.)

	1 kW	2 kW	1 kW on 2-kW transmitter	
Plate voltage	2800	2800	2800	volts
Plate current	357	714	357	mA
Plate load impedance	5000	2500	5000	ohms
Power input	1000	2000	1000	watts
Tube output (typical)	700	1400	700	watts
Power at antenna	672	1343	647	watts
Transmitter efficiency	67.2	67.1	64.7	per cent
Network efficiency	96.0	95.9	92.5	per cent
Lost in L1 (heat)	27.9	56.9	52.6	watts
Circuit Q	12	12	23.6	
Inductor Q (typical)	350	350	350	
Frequency	4.0	4.0	4.0	MHz
Antenna load	50	50	50	ohms
C1 tuning capacitor	95.5	191.0	187.8	pF
L1 inductor	17.38	9.18	9.18	μ H
C2 loading capacitor	533.8	1096.9	1703.0	pF
C1 reactance	416.7	208.3	211.9	ohms
L1 reactance	436.9	230.7	230.7	ohms
C2 reactance	74.5	36.3	23.4	ohms
Current in C1	4.49	8.98	8.83	amps
Current in L1	4.73	9.29	8.93	amps
Current in C2	2.46	7.14	7.70	amps
Voltage across C1	2645.8	2645.8	2645.8	peak volts
Voltage across C2	259.2	366.5	254.4	peak volts
Voltage on antenna	183.3	259.1	179.9	rms volts
Current in antenna	3.67	5.18	3.60	amps

One other circuit trick which can be used quite successfully is to use a dual-section variable, placing the two sections in series rather than parallel. This reduces the minimum capacitance to 10 pF or less.

broadband power amplifier

Many operators need special frequencies outside the five amateur bands for MARS or other purposes, and need a power amplifier which can be tuned up at any frequency in the range from 3.0 to 30 MHz. **Table 7** shows a pi-network design that gives continuous frequency coverage in five switch positions. A pi-L network for similar use is shown in **table 8**. The pi-L is more broadband for a given Q variation, and requires substantially less output capacitance. Both designs are for 2000-watts input with a 2800-volt plate supply, or 1000-watts input at 2000 volts.

component ratings

To determine the peak voltage across C1 you can use the maximum dc plate voltage. This is not precisely correct, but it's close enough. Normally you would increase the voltage by at least 30 per cent when selecting a capacitor to prevent arcing if the

tank circuit is not perfectly resonated, and to allow for some oxidation if you use an air variable.

There are several ways to determine peak voltage. If the power output is known at this point you can use **eq. 12** to determine peak voltage:

$$E_{pk} = \sqrt{2PZ} \quad (12)$$

where E_{pk} is the peak rf voltage, P , is output power, and Z is plate load impedance. For example, in a 1-kW transmitter with 2800 volts on the plate, the peak voltage across C1 and L1 is 2646 volts. (The power output of class-B stages may be estimated at 70 per cent of the input power as this gives some margin of protection and is suitable for this purpose).

The peak voltage across C2 can also be figured in a similar manner, except that Z in **eq. 12** is the antenna load impedance. Power output may be estimated at 65 per cent of the input. For example, if the output power is 650 watts (for a 1-kW amplifier), and the antenna load is 50 ohms, this represents approximately 254 peak volts across C2. Thus, for a 1000-watt transmitter, a 350-volt, 365-pF broadcast receiver type capacitor could be used successfully. For 2000 watts input at 2800 volts, the peak voltage across C2 would be 367 volts, and the broadcast-tuning capacitor would be too marginal.

In the pi-L network the image impedance must be used when calculating the peak voltage across capacitor C2, and the voltage rating must be substantially higher than for the same capacitor in the pi network. For example, in a 1-kW transmitter, the peak voltage across C2 is about 635 volts; for a 2000-watt amplifier the peak voltage is about 895 volts.

The peak voltage across C1 has already been determined, but to find the current through C1, rms voltage is more useful. This can be found from **eq. 13**:

$$E_{rms} = \sqrt{PZ} \quad (13)$$

where E_{rms} is the rms voltage, P is the output power, and Z is the plate load impedance. In the previous example of the 1000-watt transmitter with a 2800-volt plate supply, the rms voltage across C1 is nearly 1870 volts.

To calculate the current through C1 you must first determine the reactance of C1 (**eq. 14**) and calculate its impedance (**eq. 15**). The current is found from **eq. 16**:

$$X_c = \frac{Z_p}{Q} \quad (14)$$

$$Z_{C1} = \sqrt{R^2 + X_c^2} \quad (15)$$

$$I = \frac{E_{rms}}{Z_{C1}} \quad (16)$$

However, since the resistance of a high-quality air-variable capacitor is very small, less than 1 ohm, for all practical purposes the impedance of the capacitor is equal to its reactance. Therefore, the current can be found from

$$I = \frac{E_{rms}}{X_{CI}} \quad (17)$$

As you can see in **table 5**, the current through C1 is much higher than you might think, with nearly 4.5 amperes flowing through C1 in the 1000-watt transmitter with 2800 volts on the plate. Most air variables and vacuum capacitors can handle this current easily, but you must be careful when selecting fixed capacitors to pad the variables. Transmitting-type capacitors with high Q and good current-carrying capability are required (such as the Centralab 850 series).

The current through C2 can also be determined with **eq. 17**. However, when calculating the rms voltage across C2 the antenna load impedance must be used in **eq. 13**. Again, there is substantial current flowing through C2 — nearly 2.5 amperes in the 1000-watt transmitter.

For all practical purposes, the current through inductor L1 is equal to that through C1. It is actually a little higher, and the following formula is reasonably correct for class B:

$$I_{cc} = 1.05 Q_o I_p \quad (18)$$

where I_{cc} is the circulating current, Q_o is loaded circuit Q, and I_p is the indicated plate current. **Eq. 18** is a close approximation that compares favorably with answers derived from using complex vector analysis of reactive components used in rf circuits at resonance.

inductor power loss

To determine heat losses in the inductor, it is necessary to know the rf resistance of the inductor.

table 6. Large value at C1 and smaller inductor cause the Q on ten meters to rise very rapidly, especially when running the transmitter at a lower power input which requires 5000 ohms plate load impedance.

f (MHz)	R1	C1 (pF)	L1 (μH)	C2 (pF)	Q
29.7	2500	26	1.24	148	12.0
29.7	2500	32	1.00	210	15.0
29.7	2500	39	0.84	251	18.0
29.7	2500	45	0.72	300	21.0
29.7	2500	51	0.63	348	24.0
29.7	5000	26	1.24	234	24.0
29.7	5000	32	0.98	303	30.0
29.7	5000	45	0.70	437	42.0
29.7	5000	51	0.61	503	48.0

table 7. Pi-network component values for a broadband 3-30 MHz rf power amplifier matching a 50-ohm antenna load. This is accomplished in five bands: 3.0-5.0 MHz, 5.0-8.5 MHz, 8.5-14.4 MHz, 13.5-22.0 MHz and 20.0-30.0 MHz. The Q is set for a minimum of 12 at the top of each band. The 2500-ohm plate load impedance corresponds to a grounded-grid amplifier running 2000 watts at 2800 volts, or a 1000-watt amplifier with 2000 volts on the plate.

R1 OHMS	F MHZ	C1 PF	L1 UH	C2 PF	R2 OHMS	Q
2500	3.0	433	7.34	2878	50	20.4
2500	3.5	317	7.34	2053	50	17.4
2500	4.0	242	7.34	1517	50	15.2
2500	5.0	153	7.34	878	50	12.0
2500	5.0	265	4.32	1764	50	20.8
2500	7.0	134	4.32	834	50	14.7
2500	7.3	123	4.32	755	50	14.1
2500	8.5	90	4.32	516	50	12.0
2500	8.5	155	2.55	1034	50	20.8
2500	14.0	56	2.55	327	50	12.4
2500	14.35	54	2.55	308	50	12.1
2500	14.4	53	2.55	305	50	12.0
2500	13.5	94	1.67	621	50	19.9
2500	21.0	38	1.67	225	50	12.5
2500	21.45	37	1.67	212	50	12.3
2500	22.0	35	1.67	199	50	12.0
2500	20.0	59	1.22	383	50	18.4
2500	28.0	30	1.22	176	50	13.0
2500	29.7	26	1.22	151	50	12.2
2500	30.0	25	1.22	146	50	12.0

Then you can use **eq. 19** to find power loss.

$$P = I^2 r \quad (19)$$

where I is the circulating current and r is the rf resistance.

To minimize these losses, the inductor should be silver plated, as should all leads to the bandswitch. Power losses on the order of 30 to 100 watts are not unusual, even with low standing-wave ratios. The use of tubing is encouraged, particularly on the higher frequencies to provide better unloaded Q.

It may come as a surprise to find that the conductivity of silver is only slightly superior to that of copper. In fact, a silver-plated coil is little more efficient than a new tank coil made of copper. Copper, however, oxidizes, and the outer rf-current-carrying layer becomes less effective. On the other hand, silver develops a form of silver sulfide on its outer surface which barely affects its conductivity. Over a period of years the silver-plated coil will retain most of its original conductivity.

safety

An rf choke should be used at the antenna output of any pi or pi-L network. This choke should be large enough to blow the overload relay (or fuse) in the high-voltage power supply if the dc blocking capacitor should short out. This is the only backup protection you have to keep high dc voltage off the pi-network components if the blocking capacitor

table 8. Pi-L network component values for a broadband 3-30 MHz rf power amplifier matching a 50-ohm antenna load. This is accomplished in five bands: 3.0-5.0 MHz, 5.0-8.5 MHz, 8.5-14.4 MHz, 13.5-22.0 MHz and 20.0-30.0 MHz. The Q is set for a minimum of 12 at the top of each band. The 2500-ohm plate load impedance corresponds to a grounded-grid amplifier running 2000 watts at 2800 volts, or a 1000-watt amplifier with 2000 volts on the plate.

R1 OHMS	F MHZ	C1 PF	L1 UH	C2 PF	L2 UH	R2 OHMS	R3 OHMS	'Q' QUAL
2500	3.0	388	9.00	2004	3.90	158	50	18.3
2500	3.5	292	9.00	1489	3.90	197	50	16.0
2500	4.0	228	9.00	1042	3.90	242	50	14.4
2500	5.0	153	9.00	622	3.90	350	50	12.0
2500	5.0	237	5.29	1231	2.29	154	50	18.6
2500	7.0	127	5.29	572	2.29	253	40	14.0
2500	7.3	118	5.29	519	2.29	270	50	13.5
2500	8.5	90	5.29	366	2.29	350	50	12.0
2500	8.5	139	3.12	724	1.35	154	50	18.6
2500	14.0	56	3.12	232	1.35	330	50	12.3
2500	14.35	54	3.12	219	1.35	345	50	12.1
2500	14.4	52	3.12	216	1.35	350	50	12.0
2500	13.5	85	2.04	431	0.89	165	50	18.0
2500	21.0	38	2.04	158	0.89	325	50	12.5
2500	21.45	36	2.04	150	0.89	335	50	12.3
2500	22.0	35	2.04	141	0.89	350	50	12.0
2500	20.0	53	1.50	263	0.65	183	50	16.7
2500	28.0	29	1.50	121	0.65	315	50	12.7
2500	29.7	26	1.50	106	0.65	345	50	12.1
2500	30.0	25	1.50	104	0.65	350	50	12.0

A suitable inductor for the L-section of the pi-L network consists of 5 cm (2 inches) of Air-Dux 1606T [6 turns-per-inch (2.5cm), no. 14, 5 cm (2 inches) diameter]. It should be placed at right angles to the main pi inductor to avoid mutual inductance.

frequency	number turns	approximate inductance
3.0-5.0 MHz	10.00	3.90 μ H
5.0-8.5 MHz	6.75	2.25 μ H
8.5-14.4 MHz	4.75	1.33 μ H
12.5-22.0 MHz	3.50	0.83 μ H
20.0-30.0 MHz	3.00	0.65 μ H

shorts out. This rf choke also keeps any dc component off the antenna.

RTTY and ssb

Many amateurs are interested in RTTY as well as CW and ssb. Since RTTY is essentially 100 per cent key-down, it's quite hard on the various components in the transmitter. On ssb, the typical duty factor is 30 to 50 per cent, depending on how much ALC and other compression you use. Typically, however, the average circulating current in the network is perhaps one-third of that for key-down operation.

Table 5 shows that 2000-watts key-down gives comparable circulating currents to that of the same transmitter run at 1000-watts key-down with the same plate voltage and same inductor. This is due to the higher Q that is being used. Because of the lower duty cycle of ssb, running a 2000-watt transmitter key-down at 1000 watts for RTTY is three times as hard on the transmitter as running 2000-watts PEP! This is rather startling, and indicates why some rf power amplifiers should not be used on RTTY,

although they are perfectly suitable for ssb at higher input power levels.

Conversely, it follows that if a manufacturer guarantees his unit to run indefinitely at 1000-watts key-down RTTY, that same transmitter should last forever at 2000-watts PEP ssb. Some manufacturers hedge if this specific question is posed to them.

Using a 2000-watt rf power amplifier at the 1000-watt level for RTTY or CW poses certain inherent problems regarding heat and efficiency. High plate supply voltages raise the plate load impedance to the point where it may be difficult to get the minimum capacitance required for resonance on 10 and 15 meters.

When building a high-power final amplifier, consideration must be given to selecting components which will handle the voltage and currents encountered in the circuit. The formulas given in this article should make it relatively easy for the builder to predict what these voltages and circulating currents will be before he actually builds the amplifier.

Computer-derived tables provide much data for the builder, and clarify many design points only hinted at in previous articles. I hope that the information presented here will be of benefit to anyone who builds or buys a final rf power amplifier.

acknowledgements

Many people are interested in pi and pi-L networks, and have been of direct assistance. Providing particular assistance was Bob Sutherland, W6UOV, or EIMAC. I also spent a great deal of time reading articles written by George Grammer, W1DF, former Technical Editor of QST. His work in this field, and his series of three articles in QST⁵ represent an outstanding contribution. Bill Craig, WB4FPK, was most helpful, as was Garey Barrell, K4OAH. Bill Carver, K6OLG, also provided stimulating comments.

The Computer Terminal Corporation of San Antonio, Texas, provided over 100 hours of computer terminal time which was invaluable in this project.

references

1. Collins Radio Company, "Fundamentals of Single Sideband," second edition, 1965, page 7-6.
2. George Grammer, W1DF, "Simplified Design of Impedance-Matching Networks, Part II," QST, April, 1957, page 32.
3. American Radio Relay League, "Radio Amateur's Handbook," 49th edition, 1971, page 158.
4. Douglas Blakeslee, W1KLL, and Carl Smith, W1ETU, "Some Notes on the Design and Construction of Grounded-Grid Linear Amplifiers," QST, December, 1970, page 22.
5. George Grammer, "Simplified Design of Impedance-Matching Networks," Parts I and III, QST, March, 1957, page 38, and May, 1957, page 29.

ham radio

Incredible...



Incredible, that's the word people are using to describe the CT-50 frequency counter. Why? Simple, the CT-50 is an achievement in design; exceptionally low in cost, compact, easy to use and unmatched in performance and reliability.

Features of the CT-50 include; easy pushbutton operation, fully automatic decimal point positioning, quality shielded metal case, and dependable LSI circuitry. Full eight digit readout allows resolution to 1 Hz at 65 MHz, 10 Hz at 650 MHz, and the decimal point is always correct. Input protection to 50 volts insures against accidental burnout or overload. And, the best feature of all is the easy assembly. Clear, step by step instructions guide you to a finished unit you can rely on.

Use the order blank below or call us direct and order yours today!

CT-50, 60 MHz Counter Kit	\$89.95
CT-50 WT, 60 MHz counter, wired, tested	159.95
CT-600, 600 MHz prescaler option for CT-50, add	29.95

ACCESSORIES

DC probe, direct input, general purpose type	\$12.95
High impedance probe, does not load circuit	15.95
Low pass probe, used when measuring audio	15.95
High pass probe, reduces low freq pickup	15.95
VHF flexible rubber antenna, BNC connector	12.95
Color burst adapter, for calibration, high accuracy typically 0.001 ppm accuracy, stability	14.95

ramsey electronics

P.O. Box 4072 Rochester NY 14610

(716) 271-6487

SPECIFICATIONS

Frequency range: 5 Hz to 65 MHz, 600 MHz with CT-600

Resolution: 10 Hz @ 0.1 sec gate, 1 Hz @ 1 sec gate

Readout: 8 digit, 0.4" high LED, direct readout in mHz

Accuracy: adjustable to 0.5 ppm

Stability: 2.0 ppm over 10° to 40° C, temperature compensated

Input: BNC, 1 megohm / 20 pf direct, 50 ohm with CT-600

Overload: 50VAC maximum, all modes

Sensitivity: less than 25 mv to 65 MHz, 50-150 mv to 600 MHz

Power: 110 VAC 5 Watts or 12 VDC @ 400 ma

Size: 6" x 4" x 2", high quality aluminum case, 2 lbs

ICS: 13 units, all socketed

CT-600: 600 MHz prescaler option, fits inside CT-50

CB-1: Color burst adapter, use with color TV for extreme accuracy and stability, typically 0.001 ppm

Ramsey Electronics

Box 4072 716-271-6487

Rochester, NY 14610



Quantity	Description	Price
	Shipping, handling, insurance	\$5.00
	N.Y. state residents, add tax	
	Total	
Name _____		
Address _____		
City _____ State _____ Zip _____		

FOØXA-H CLIPPERTON '78

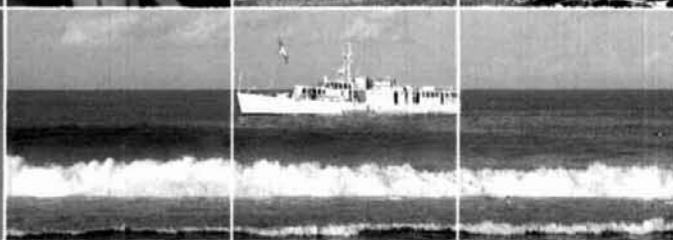

GREATEST DXpedition OF THEM ALL!

WA9INK W6SO WA4WME N6IC W6QKI W6HVN



F6AQD HB9AHL F6AOI F9IE HB9(SWL) F6ARC
HB9AEE F5II F6BFH F9JS F6BBJ

ATLAS 350-XL Champion of Clipperton!

If you were one of the fortunate 29,069 hams who worked Clipperton Island in March of 1978, you've worked an Atlas 350-XL transceiver. The 350-XL was selected by the DXpedition logistics team, headed by Don Bostrom, N6IC, because it had all of the necessary features required for the operation contained in one compact package. This included primary and auxiliary VFO's for split frequency operation, digital frequency display with accuracy of ± 50 Hz, VOX for SSB and full break-in for CW, sidetone, more than 200 watts output (twice that of most other transceivers), all solid state design permitting efficient operation from a storage battery if necessary. And above all, rugged design and construction that permits hour after hour of continuous operation without failure.

"The 350-XL is a fine, rugged transceiver . . . even works after a salt water bath . . ." Willy, HB9AHL



One very important point we want to make clear . . . the Clipperton DXpedition was financed by the 16 operators who went there, and by many generous donations from DX clubs, radio clubs, individual hams, and others. Atlas Radio was not a financial sponsor, except to the extent of loaning equipment. Other manufacturers provided similar support.

"As equipment logistics manager, my selection of the Atlas 350-XL proved to be the perfect choice . . ." Don, N6IC

Needless to say, we at Atlas Radio were very pleased when the team chose the 350-XL as the transceiver for all 3 stations. At that point, how could I (W6QKI) turn down the invitation to join the team, and to share in a tremendous adventure? Did I go along to keep our radios working? Well, truthfully I brought along a box full of spare parts and pieces. Happily I can report that the box could have stayed at home. And there are 15 witnesses who will verify this. Their unanimous and whole hearted endorsement of the 350-XL is most gratifying.

Many of you will be interested in how the 3 stations were organized. Number 1 station was set up in the metal Quonset-type building which the French put up in 1957 during the IGY scientific work conducted on the island. This station worked

strictly 20 meters 'round the clock for 7 days, SSB and CW. It included a Dentron MLA-2500 Linear which was used much of the time to break through to Europe and other distant points. The antenna was a Wilson 4 element monobander about 30 feet high. Power was supplied by a 2500 watt Honda gasoline generator. This station ran continuously for 7 days, and made 11,158 contacts! Problems, zero!

"Unbelievable performance and reliability under extremely adverse portable conditions and constant use by DXpedition multi-operators . . ." Hugh, WA4WME

Incidentally, we took one box ashore which contained 3 fans. They were intended for blowing air on the transceiver heat sinks. The box is still on the island, unopened! Ambient temperature outside was 85 degrees F. Inside the metal building? Up to 95 degrees!

Station Number 2 was located about 200 feet from Number 1, and was set up in a tent. It worked 10 meters daytime, 80 and 160 meters at night. A Dentron MLA-2500 Linear was used, mainly on 80 and 160, some of the time on 10 meters. A 3 element Wilson monobander was used on 10. A doublet was used on 80 meters, later changed to a Delta loop by F6ARC, a KLM vertical with ground radials worked very well on 160 meters. A Dentron MT-3000 antenna tuner was used on 80 and 160. Power was supplied by a Sears 2200 watt generator. This station averaged 21 to 22 hours operation each of the 7 days. Problems? The digital frequency display made signs of acting up. One of the IC's was replaced. A 5 minute job. The rig had been liberally sprayed with salt water on the trip in through the surf, as also was the Dentron linear. Total contacts from station Number 2 were 6401 on 10 meters, 1644 on 80 meters, and 202 on 160 meters.

"Clipperton: The best location for DXers. Atlas 350-XL: The best equipment for hardest DXpedition. Result: One of the best DXpeditions ever . . ." Jack, F5II/FOØXB

Station Number 3 was located in a tent about 300 feet (and 5000 crabs) from Number 2. It operated on 15 and 40 meters. Foreign broadcast QRM was very rough on 40, so most operating time was on

15 using a Wilson 3 element monobander. No linear was used at this station because the generator would not provide enough power.

So, if you heard Clipperton on 15 or 40 meters, it was strictly barefoot. A Dentron MT-3000 tuner was used with a KLM vertical on 40 meters. Station Number 3 ran all week on a generator that delivered 155 volts AC when receiving . . . and only 75 to 90 volts during transmit! We were unable to adjust the problem, so simply let it go. Didn't bother the rig. Total contacts on 15 meters numbered 7194, second only to 20 meters! 40 meters netted 2450 contacts.

This report hardly is complete if we don't mention 6 meters and Oscar. N6IC and W6SO were the Oscar specialists. Unfortunately, some equipment difficulty (not Atlas) limited Oscar contacts to only 20. Rather disappointing, but the best we could do, and the guys really tried. 6 meters just never produced an opening. We monitored every-day without ever hearing a signal.

"I cannot say enough about the excellent performance of the Atlas equipment. Under the most trying conditions of operation the gear came through with flying colors. With 16 operators pushing switches and twisting knobs 24 hours a day for 7 days, the equipment never faltered. Truly remarkable. The success of the DXpedition was due in large to the faultless operation of the 350-XL . . ." Hoppy, W6SO

All in all, we feel the performance record on the HF bands is something to brag about, and hope you'll pardon us for indulging. One final thing to boast about was really unexpected. The ride through the surf back to the ship was quite a ride. Everyone, and everything thoroughly soaked. Much of the gear was full submerged. But all 3 of the 350-XL's worked normally after drying out! Being very low on fresh water we could not afford to wash the gear down. All we could do was dry them out in the sun. Obviously, as soon as we got back we had to wash out the salt and clean the sets up. But, they were used "maritime-mobile" on the trip back to San Diego.

The Clipperton '78 DXpedition was undoubtedly the biggest expedition and adventure of its kind ever put together, and turned out to be a smashing success in all respects. All the gang at Atlas is mighty proud at how well the 350-XL proved itself, truly a great performer; a real classic that will set the pace for years to come.

73

Herb Johnson

W6QKI



**ATLAS
RADIO INC.**

417 Via Del Monte, Oceanside, CA 92054

(714) 433-1983

Special Customer Service Direct Line (714) 433-9591
TWX 910-322-1397

programming for automated satellite communication

Following the lead of Ball in February *ham radio*, author Milazzo has also derived the equations for tracking Oscar — emphasis in this case has been placed on developing a program suitable for use with the Texas Instruments calculators which use algebraic notation

Of primary importance in satellite communication is the required antenna orientation and the time during which the satellite is available from the ground station. Such information increases the dependability and efficiency of satellite use. Presently, the means of obtaining this data is widely available due to the increased popularity of low-cost programmable calculators and minicomputers.

Previous articles have dealt with the prediction of equatorial crossings.^{1,2} These offer few advantages

fig. 1. Basic figure used for the derivation of the main equations to track the satellite; the law of cosines for spherical trigonometry applies to this figure.

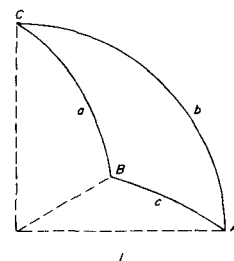

since such information is published monthly and interpolation of this data is easily accomplished. Other articles do offer more useful information but require the use of slide-rule type devices which are imprecise and incapable of being interfaced with station equipment.^{3,4}

This article presents a series of equations for deter-

By Charles F. Milazzo, KP4MD, University of Puerto Rico School of Medicine, Apartado 2-2, GPO Box 5067, San Juan, Puerto Rico 00936.

mining the exact position of any earth satellite that approximates a circular orbit, at any given time. The calculations are useful for manually or automatically tracking a satellite, for preparing tables for future reference, or for alerting the operator when a satellite is approaching. This algorithm has been used to prepare programs for the Texas Instruments SR-52 calculator, but can be programmed for other calculators and computers as well.

theory

The theoretical model considers the earth as a stationary sphere with the satellite travelling in a circular orbit moving from east to west. Thus, the coordinates of the ground station remain constant while those of the satellite vary as a function of time. Solving this problem involves the application of spherical trigonometry which implies that the computer must be supplied subroutines for trigonometric functions. Algebraic methods for evaluating these functions are found in various references.^{5,6}

The main equations are derived from the law of cosines of spherical trigonometry (see **fig. 1**).

$$\cos a = \cos b \cos c + \sin b \sin c \cos A$$

To calculate the latitude and longitude of the satellite, the angle labelled *A* is placed at the equator crossing point of a reference orbit, angle *B* is at the satellite's position at time *T*, and angle *C* is at the North Pole. Thus, *A* is equal to 360° minus the orbital azimuth during equator crossing ($A = 360^\circ - \alpha_{eqx}$), and *C* is equal to longitudinal displacement of the satellite from the reference crossing ($C = \lambda_s - \lambda_{eqx}$). Side *a* is the complement of the satellite's latitude ($a = 90^\circ - \psi_s$), side *b* is a function of the orbital period *P_s* and of the time elapsed from the reference crossing [$b = 360^\circ(T - T_{eqx})/P_s$], and side *c* is 90°.

Substituting known values into the equation for the law of cosines results in:

$$\begin{aligned} \cos(90^\circ - \psi_s) &= \cos[360^\circ(T - T_{eqx})/P_s] \cos 90^\circ + \\ &\sin[360^\circ(T - T_{eqx})/P_s] \sin 90^\circ \\ &\cos(360^\circ - \alpha_{eqx}) \end{aligned}$$

fig. 2. Calculation of the antenna elevation is based on this plane geometric figure. *R_s* is the orbital radius, referenced to the center of the earth.

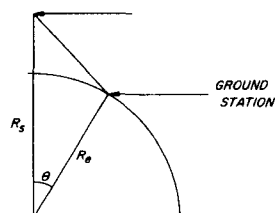

which simplifies and rearranges to give the satellite latitude

$$\psi_s = \arcsin \{ \sin[360^\circ(T - T_{eqx})/P_s] \cos \alpha_{eqx} \}$$

The result is used again in the same equation to calculate angle *C*

$$\begin{aligned} \cos[360^\circ(T - T_{eqx})/P_s] &= \cos(90^\circ - \psi_s) \cos 90^\circ + \\ &\sin(90^\circ - \psi_s) \sin 90^\circ \cos C \end{aligned}$$

which rearranges to give

$$C = \arccos \{ \cos[360^\circ(T - T_{eqx})/P_s] \cos \psi_s \}$$

The true longitude of the satellite is calculated by adding the longitude of the equator crossing reference point (λ_{eqx}), changing the sign of *C* when the satellite is in the Southern Hemisphere, adding the displacement due to the earth's rotation (0.25°/min), and compensating for a constant orbital drift factor (*D*) if necessary.

$$\begin{aligned} \lambda_s &= (|\psi_s|/\psi_s) \arccos \left\{ \frac{\cos[360^\circ(T - T_{eqx})/P_s]}{\cos \psi_s} \right\} \\ &+ \lambda_{eqx} + (T - T_{eqx})(0.25 + D) \end{aligned}$$

Again referring to **fig. 1**, angle *A* is now placed at the location of the ground station and is equal to 360° minus the correct antenna azimuth ($A = 360^\circ - \alpha_{gs}$). Angle *C* is the difference between the longitudes of the satellite and the ground station ($C = \lambda_s - \lambda_g$). If *C* is greater than zero, then the true azimuth is 360° minus α_{gs} . Side *b* is the complement of the ground station's latitude ($b = 90^\circ - \psi_g$), and side *c* is the distance from the ground station to the satellite in great circle degrees ($c = \theta$). Side *c* is calculated using the law of cosines.

$$\begin{aligned} \cos \theta &= \cos(90^\circ - \psi_s) \cos(90^\circ - \psi_g) + \\ &\sin(90^\circ - \psi_s) \sin(90^\circ - \psi_g) \cos(\lambda_s - \lambda_g) \end{aligned}$$

which simplifies to give the degrees distance

$$\theta = \arccos[\sin \psi_s \sin \psi_g + \cos \psi_s \cos \psi_g \cos(\lambda_s - \lambda_g)]$$

This value is used to calculate the azimuth

$$\begin{aligned} \cos(90^\circ - \psi_s) &= \cos(90^\circ - \psi_g) \cos \theta + \\ &\sin(90^\circ - \psi_g) \sin \theta \cos \alpha_{gs} \end{aligned}$$

which rearranges to give

$$\alpha_{gs} = \arccos[(\sin \psi_s - \sin \psi_g \cos \theta) / \cos \psi_g \sin \theta]$$

The antenna elevation is calculated using a plane geometric model as shown in **fig. 2**. R_e is the earth's radius (6371.315km) and R_s is the orbital radius. According to Newton's law of gravitation, the radius of a circular orbit is a function of the orbital period. For any satellite in such an orbit, the centrifugal force ($F = mv^2/R_s$) is equal to the gravitational force ($F = GM_e m/R_s^2$). The velocity of the satellite is equal to the orbital circumference divided by the orbital

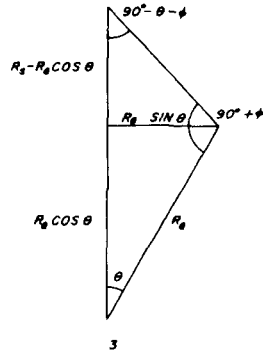

fig. 3. By drawing a perpendicular line from the ground station to the orbital radius line, all angles and distances can be analyzed using basic trigonometric functions. As shown in the text, the actual antenna elevation angle is derived by this method.

period in seconds ($v = 2\pi R_s / 60P_s$), when P_s is in minutes. GM_e is the earth's gravitational constant ($398603 \text{ km}^3/\text{s}^2$). Thus, we can calculate the orbital radius by equating the centrifugal and gravitational forces

$$m(2\pi R_s / 60P_s)^2 / R_s = GM_e m / R_s^2$$

or

$$R_s = \sqrt[3]{GM_e (30P_s / \pi)^2}$$

Fig. 3 shows the trigonometric relationships which result when a perpendicular is drawn from the ground station to the R_s line. Solving for the angle whose apex is at the satellite's position yields

$$90^\circ - \theta - \phi = \arctan [R_e \sin \theta / (R_s - R_e \cos \theta)]$$

which rearranges to give the antenna elevation

$$\phi = \arctan [(R_s - R_e \cos \theta) / R_e \sin \theta] - \theta$$

If the satellite is below the horizon, the antenna elevation will be a negative number. This is useful as a conditional test to determine if the satellite is within range.

Ground distance is directly proportional to the arc distance and can be found by $D = k\theta$, where k is 111.14 for kilometers, or 69.06 for statute miles.

Direct line-of-sight distance can also be determined by the law of cosines (**fig. 4**).

$$D = \sqrt{R_s^2 + R_e^2 - 2R_s R_e \cos \theta}$$

The constants for the Oscar 6 and 7 satellites are as follows:

	α_{eqx}	P_s	D
Oscar 8	351.0100°	103.23162 min	0
Oscar 7	348.2990°	114.94483 min	0

the SR-52 program

Due to the complexity of the calculations required, the program is divided into two modules.* The first module enters the appropriate reference and constant information into the data memory, while the second module computes the satellite's position and direction in terms of azimuth and elevation from a specified ground location. In the second module, the desired time is entered from which the calculator displays the elevation angle, indicating if the satellite is within range. The azimuth and arc distance can then be called from the calculator. To facilitate the tabulation of the results, one key has been programmed to advance or reverse the position of the satellite by a desired number of minutes. The following example demonstrates the use of the program.

The antenna aiming data for the first Oscar 7 pass of August 1, 1977 is desired. The first program card is read into the calculator, and the R/D switch is placed in the degrees mode. A reference orbit from January 1, 1977 is available. The satellite is found to cross the equator at 77.0° west longitude at 0148:49 on January 1. The station coordinates are 18°25' north latitude and 65°58' west longitude. Therefore, the following key sequence is executed:

enter	press	display	
7	A	7	(satellite #)
1	B'	2400	(enter date)
148.49	B	1548.82	
77.0	C	77.	
18.25	D	18.42	
65.58	E	65.97	

The second card is now read into the calculator. Since the exact time of acquisition is not known, a rough estimate can be made based on the fact that the satellite travels at about 3 degrees per minute and

*A copy of the program is available by sending a self-addressed, stamped envelope to *ham radio*, Greenville, New Hampshire 03048.

it must be within 36 degrees of the station to be heard. First, determine if the satellite is within range at 0000 GMT on August 1 (213th day of 1977).

enter	press	display	
213	A	511200	(enter date)
0	A	-9.23	(enter time/ disp. elev.)
	C	45.8	(disp. distance)

The negative value for elevation showed that the satellite is below the horizon at 0000 GMT, while pressing C showed that it is about 10 degrees beyond the 36 degree range limit. If the satellite is approaching, it will take about four minutes to come within range. Advancing the satellite four minutes produces:

enter	press	display	
4	E	2.25	(elevation)
	B	147.8	(azimuth)
	C	33.4	(distance)

The satellite can be advanced at one minute intervals to produce a listing for this pass.

time	elevation	azimuth	distance
0004	2.2	147.8	33.4
0005	5.7	146.2	30.3
0006	9.4	144.3	27.2
0007	13.5	142.0	24.2
0008	18.1	139.0	21.2
0009	23.4	135.1	18.3
0010	29.3	129.8	15.5
0011	35.9	122.4	12.9
0012	42.7	111.5	10.6
0013	48.7	95.5	8.8
0014	51.6	74.3	8.0
0015	50.1	52.1	8.5
0016	44.8	34.3	9.9
0017	38.1	22.0	12.1
0018	31.3	13.6	14.6
0019	25.2	7.8	17.4
0020	19.7	3.7	20.3
0021	14.9	0.6	23.3
0022	10.6	358.1	26.3
0023	6.7	356.2	29.4
0024	3.2	354.7	32.4
0025	0.0	353.5	35.6

Results from this program have been compared with published equatorial crossing data, with the predicted coordinates accurate to within one tenth of one degree for both Oscar 6 and Oscar 7. This, for one year from a single reference orbit.

The user instructions for the program are straightforward, but the following hints are useful. A date need not be entered if the reference and unknown orbits occur within the same day. When entering a date, it must always be entered before the time. The dates of the reference and unknown orbits must be either within the same month, or else each day of the year must be assigned a consecutive number. The

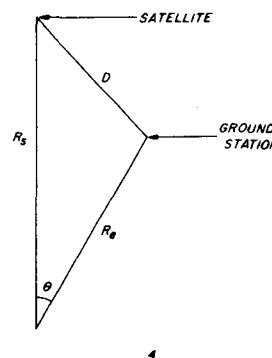

fig. 4. The direct line-of-sight distance to the satellite is calculated using the law of cosines and this figure.

“+ Time” key may be used to reverse the satellite’s position by merely entering the negative value of the desired number of minutes. Finally, if you desire to enter a new time without using the “+ Time” key, it is necessary to re-enter the date (if used) before entering the new time. I can supply the program on magnetic cards with any station coordinates and reference orbit recorded for the cost of \$5. This includes program documentation.

conclusion

By using the preceding equations, any person can build his own computerized satellite tracking station by interfacing a digital clock and station controls to a microcomputer. Even without a computer, this program offers valuable, accurate information for any satellite operator.

references

1. Joe Kasser, G2ZCZ, “Oscar Orbits on your Altair,” 73, November, 1976, page 146.
2. Loring C. White, W1ODI, “Satellite Orbit Predicting,” 73, August, 1976, page 113.
3. Kazimierz Deskur, K2ZRO, “Shoot Oscar with a Satellabe,” 73, July, 1975, page 33.
4. Charles J. Harris, WB2CHO and Joel P. Kleinman, “The Oscarlocator,” QST, November, 1976, page 51.
5. R. S. Burlington, *Handbook of Mathematical Tables and Formulas*, McGraw-Hill, New York, 1965, page 56.
6. R. C. Weast, editor, *CRC Handbook of Tables for Mathematics*, Chemical Rubber Company, Cleveland, 1967, page 581.

ham radio

The TR-7400A 2-meter FM transceiver provides fully synthesized operation, including 600-kHz repeater offsets, over the entire 144-148-MHz range. It can operate on any of 800 channels, spaced 5 kHz apart. RF output is at least 25 W, and typically 30 W. A low power position produces 5-15 W (adjustable). Included is a dual frequency readout with large six-digit LED display plus a dial readout. The subaudible CTCSS signaling feature may be used on transmit and receive, or transmit only. Optional tone-burst modules are available. Receiver sensitivity is better than 0.4 μ V for 20 dB quieting. Large, high-Q, helical resonators minimize interference from outside the band. A two-pole 10.7-MHz monolithic crystal filter provides excellent selectivity. Optional active filters are available for 15-kHz "split" operation. Intermodulation distortion is down more than 66 dB, spurious rejection is better than -60 dB, and image rejection is better than -70 dB.

The fully-synthesized TR-7400A 2-meter FM transceiver operates on 800 channels and features repeater offset over the entire 144-148-MHz range, dual frequency readout, six-digit display, and subaudible tone encoder and decoder. RF output is at least 25 watts!

See your local Authorized Kenwood Dealer today, for a demonstration of the fantastic TR-7400A.

TR-7400A

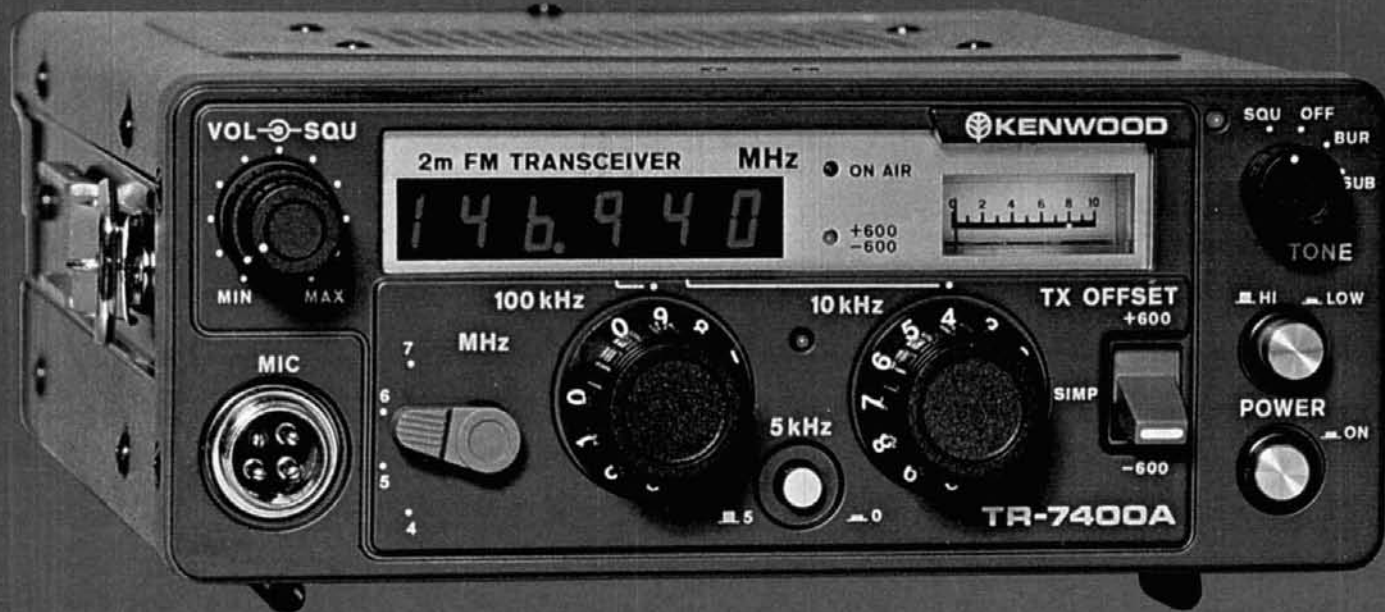

PS-8

The PS-8 AC power supply matches the TR-7400A 2-meter FM transceiver, and produces 13.8 VDC at 8 A intermittent (50% duty cycle) and 5 A continuous. It can also be used with other Kenwood VHF and UHF mobile transceivers. It is well-regulated (less than $\pm 4\%$ fluctuation), has low ripple (less than 10 mV rms), and features current limiting (less than 3 A short circuit).



MC-30S & 35S

The MC-30S and MC-35S dynamic mobile microphones provide 150-5000 Hz frequency response (150-4000 Hz when operated as noise-cancelling microphones). The MC-30S impedance is 500 Ω and the MC-35S is 50 k Ω .

INTRODUCING THE ULTIMATE IN RECEIVER DESIGN ... THE KENWOOD R-820

With more features than ever before available in a ham-band receiver. This triple-conversion (8.33 MHz, 455 kHz, and 50 kHz IFs) receiver, covering all Amateur bands from 160 through 10 meters, as well as several shortwave broadcast bands, features digital as well as analog frequency readouts, notch filter, IF shift, variable bandwidth tuning, sharp IF filters, noise blanker, stepped RF attenuator, 25 kHz calibrator, and many other features, providing more operating conveniences than any other ham-band receiver. The R-820 may be used in conjunction with the Kenwood TS-820 series transceiver, providing full transceive frequency control.

R-820

- A S-METER** Easy-to-read, calibrated to 59 + 40 dB full scale and dB μ V
- B STANDBY/RECEIVE SWITCH** Disables audio circuits during transmit mode with associated transmitter.
- C CALIBRATOR SWITCH** Built-in crystal calibrator, settable to WWV, provides signal every 25 kHz.
- D NOISE-BLANKER SWITCH** A specially designed crystal filter eliminates noise pulses such as ignition-noise interference.
- E MONITOR SWITCH** RF sampling allows user to hear his own voice when using associated transmitter.
- F AGC SWITCH** Automatic gain-control circuit switchable to slow or fast response, or completely off.
- G RECORD JACK** Makes recording off the air simple.
- H HEADPHONE JACK** Provision for plugging in headphones.
- I MODE SWITCH** Selection of AM, CW, upper or lower sideband, or RTTY.
- J RF-ATTENUATOR SWITCH** 10 dB steps of attenuation from 0 to 40 dB, to prevent overloading from nearby stations, and for precise signal comparison.
- K DIGITAL HOLD** Locks counter and display while VFO is tuned to another frequency. Helps return to "hold" frequency.
- L VFO/CRYSTAL SWITCH** Permits VFO control or crystal control on four selectable frequencies.
- M LED INDICATORS** Light-emitting diodes indicate activation of notch filter, crystal-controlled reception, VFO control, and RIT.
- N DRS DIAL** Satin-smooth VFO tuning dial system provides easy analog frequency readout (useful when digital hold is activated). LSB, USB, and CW frequencies are accurately read from the same pointer.
- O NOISE-BLANKER LEVEL CONTROL** Controls level of blanking, for maximum effect in eliminating noise interference.
- P MONITOR CONTROL** Adjusts level of RF sampling
- Q TONE CONTROL** Varies audio-output frequency response.
- R TRANSCIVE SWITCH** Selects frequency tuning from either the receiver or TS-820 series transceiver.
- S VBT/SELECTIVITY CONTROLS** Separate controls on the same shaft provide variable bandwidth tuning as well as selection of four IF filters: 250 Hz, 500 Hz, 2.4 kHz, and 6 kHz* (optional). CW filters function in 455-kHz IF for superior shape factor.
- T PRESELECTOR** Peaks tuned circuits in RF amplifier stage for increased selectivity and sensitivity. RF amplifier coil is dual-tuned.
- U RIT/NOTCH CONTROLS** RIT allows receiver to be tuned off frequency, while not affecting transmit frequency, when in transceive mode with TS-820. Notch control tunes notch within IF passband for eliminating interference. Notch frequency remains the same, even when IF shift is utilized.

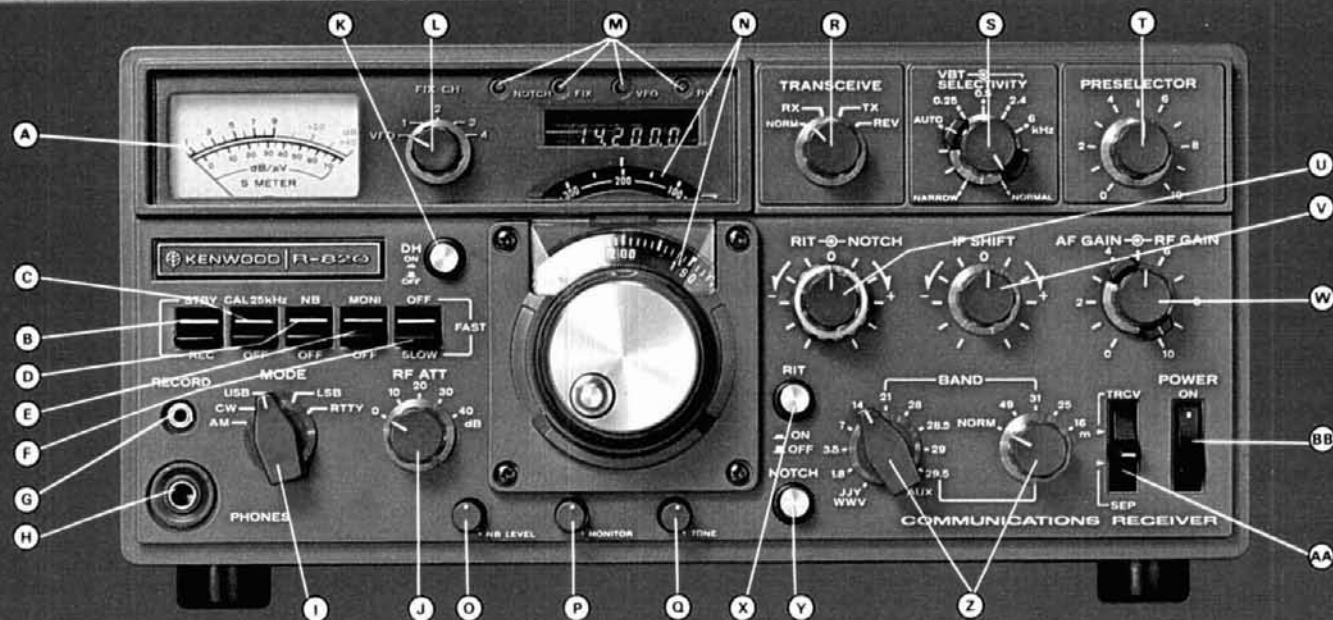

- V IF SHIFT** Varies (shifts) IF passband away from interfering signal.
- W AF GAIN/RF GAIN** Separate controls adjust volume and RF gain.
- X RIT SWITCH** Allows tuning off frequency with RIT control, and return immediately to VFO frequency by pushing switch.
- Y NOTCH SWITCH** Takes variable notch filter in and out of circuit.
- Z BAND SWITCHES** Selects frequency bands from 15 MHz (WWV), 160 through 10 meters, the 49, 31, 25, and 16-meter shortwave broadcast bands, and an auxiliary band.
- AA TRANSCIVE/SEPARATE SWITCH** Enables receiver VFO to control the receiver and TS-820 (or TS-820S) frequency (or the TS-820 VFO to control both), or both can function independently.
- BB POWER SWITCH** Turns receiver on and off.

R-820 PERFORMANCE SPECIFICATIONS

Frequency Range:

160 meters (1.8-2.0 MHz)
80 meters (3.5-4.0 MHz)
40 meters (7.0-7.5 MHz)
20 meters (14.0-14.5 MHz)
15 meters (21.0-21.5 MHz)
10 meters (28.0-28.5 MHz)
10 meters (28.5-29.0 MHz)
10 meters (29.0-29.5 MHz)
10 meters (29.5-30.0 MHz)
19 meters (15.0(WWV)-15.5 MHz)
49 meters (5.9-6.4 MHz)
31 meters (9.4-9.9 MHz)
25 meters (11.5-12.0 MHz)
16 meters (17.7-18.2 MHz)

Auxiliary band

Modes: AM, CW, USB, LSB, RTTY
 Sensitivity: 160-10 m, 19 m, SSB, 0.25 μ V at 10 dB S+N/N
 AM, 1.5 μ V at 10 dB S+N/N
 49, 31, 25, 16 m, SSB, 0.5 μ V at 10 dB S+N/N
 AM, 3.0 μ V at 10 dB S+N/N
 Selectivity: CW (with optional 250-Hz filter), 250 Hz (-6 dB), 500 Hz (-60 dB)
 CW (with optional 500-Hz filter), 500 Hz (-6 dB), 850 Hz (-60 dB)
 SSB (2.4-kHz filter), 2.4 kHz (-6 dB), 4.4 kHz (-60 dB)
 AM (6-kHz filter), 6 kHz (-6 dB), 12 kHz (-60 dB)
 Image Ratio: 160-10 m, 19 m, 80 dB
 49, 31, 25, 16 m, 60 dB
 IF Rejection: 160-10 m, 19 m, 90 dB
 49, 31, 25, 16 m, 50 dB
 Power Requirements: 100/120/220/240 VAC, 50/60 Hz, or 12-15 VDC
 Dimensions: 13-1/8" (333 mm)W x 6" (153 mm)H x 13-3/16" (335 mm)D
 Weight: 26.4 lbs (12 kg)

TRIO-KENWOOD COMMUNICATIONS INC.
1111 WEST WALNUT/COMPTON, CA 90220



protecting solid-state devices from voltage transients

There has been a great deal of discussion lately about solid-state equipment failing "for no apparent reason." If you have experienced such an occurrence and you can't explain it, chances are your solid-state gear has been zapped by a voltage transient. These are the little "gremlins" that can appear at any time, unannounced, and proceed to do their dirty work on your favorite electronic device (even when it is turned off).

While this problem may appear at first to be a recent phenomenon, it may surprise many of you to learn that voltage transients have been around for a long, long time. Why, then, have we begun to experience solid-state equipment failures (traceable to transients) only in the last few years?

The key to answering this question begins with an examination of the way equipment is built today as compared to 10 or 15 years ago. The one major and obvious difference is the use of solid-state devices in place of vacuum tubes. While transients have been around for a long time, they never bothered vacuum tubes, which can withstand momentary abuses without damage. Consequently, we have never paid much attention to the elusive voltage transient. To summarize our present situation, we know that:

1. High energy voltage transients can destroy solid-state devices.
2. We must design circuits more conservatively or add protective devices to suppress the transients.
3. We must try to eliminate some of the man-made causes of voltage transients.

In this article, I hope to provide you with some information on what voltage transients are, what causes them, why protection is necessary, and how to detect and suppress transients.

what are voltage transients?

To begin with, voltage transients are generally considered to be abnormally high voltages, occurring in a place where they don't belong, for an extremely

short period of time (usually in the nanosecond range). These transients can be generated by a device within the electronic gear (relays or SCRs) or they may come from a number of external sources such as lightning or power line switching.

For example, if an electric current is made to increase or decrease rapidly in an inductive circuit, an extremely high voltage will be generated (directly proportional to the amount of inductance and the rate at which the current is attempting to change). While this all happens very fast, there is a possibility that enough energy will be generated to exceed the breakdown characteristics of the solid-state components in the conduit.

Another problem area exists with transients caused by outside sources that find their way into solid-state equipment through power connections, antenna lead-ins, and other signal inputs to the equipment. This type of transient is much harder to control than the internal transient, and yet can produce just as much damage.

sources of voltage transients

As discussed earlier, transients may be generated under all types of conditions, and may occur on an ac line as well as dc bus. An example of the generation of an internal transient is one that occurs in the windings of the transformer in a power supply. If the line switch on the primary side of the transformer is opened at the exact instant that the transformer core is beginning a downward swing of magnetization current (fig. 1A), a voltage spike is developed on the secondary winding of the transformer. The same thing can happen when the power supply is first turned on (fig. 1B). In this example, we are causing a rapid increase of current in an inductive circuit (the transformer winding) and the result is a momentary spike on the secondary circuit.

While the previous two examples involve ac circuits, the same phenomenon can occur with the interruption of dc circuits that supply inductive loads. A diode connected across the coil of a dc relay is a good example (fig. 1C). When power is interrupted, this circuit is designed to conduct and thereby clip any high-voltage transients that may be developed.

By W. J. Prudhomme, WB5DEP, 6419 Rosalie Court, Metairie, Louisiana 70003

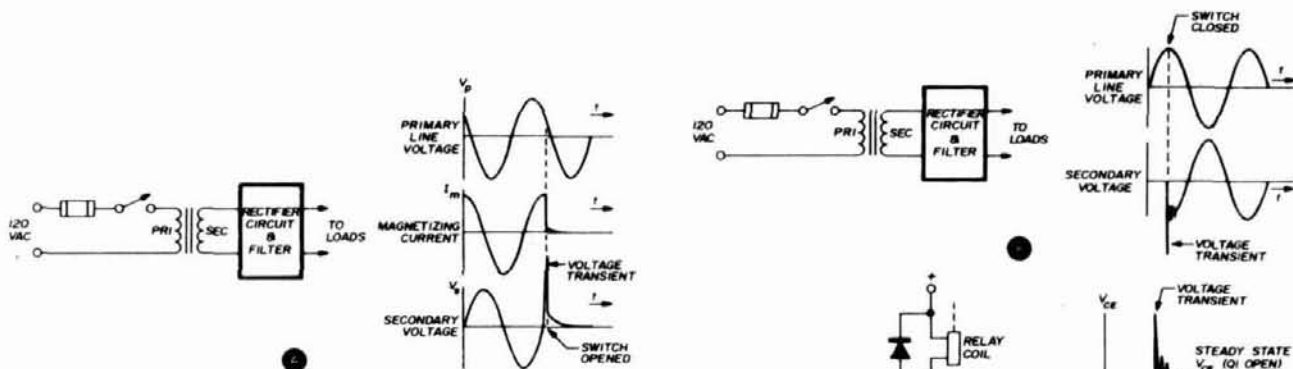

fig. 1. Examples of the way in which voltage transients are formed. In A, the transient is created by opening the switch at the peak of the magnetizing current, while in B it's formed by closing the primary switch at the peak of the primary voltage. Switching the inductive load, as shown in C, will also generate a transient on the V_{ce} line.

As far as outside sources of voltage transients, one of the most common is lightning striking a power line during a storm. Even when the strike is several kilometers away, it can readily travel through the utility's power lines and play havoc with solid-state equipment. Also, lightning in the area can generate voltage spikes on your antenna that easily find their way into the sensitive rf stages of receivers and transceivers. Here again, the actual lightning may be kilometers away and still generate enough transient energy to damage unprotected equipment.

When I was younger and didn't know better, I used to connect an NE-2 neon lamp across the lead-in of an unused antenna to detect these occurrences. Even when an electrical storm was far away (and although the NE-2 requires about 90 volts to ignite), it would

flash with almost every lightning strike. Naturally, for safety reasons, I don't recommend that anyone try this experiment. However, it should give you some idea of the amount of energy an antenna system can absorb and what can happen if you don't protect sensitive rf circuits.

Other forms of ac voltage transients may come from arcing contactors, incandescent lighting dimmers, electric drills, appliance motors with brushes, power-line switching, and many more. Also, air conditioning motor-starting contactors can produce damaging transients, as well as relays in the control circuits.

why is protection required?

To further illustrate the fact that sensitive solid-state equipment should be properly protected, refer to a study conducted by the General Electric Company in 1969.¹ In this study, which took two years to complete, surge voltages in both residential and industrial circuits were measured at 400 different locations in twenty cities.

Surprisingly, higher surge levels were recorded in the residential circuits than in the industrial areas. In addition, the results showed a peak as high as 2500 volts generated by a motor contactor within a residence, and nearby lightning generated a 5600-volt peak on a 120-volt residential service. There were also a significant number of surges in excess of 2000 volts occurring in homes on a repetitive basis.

The GE study proved conclusively that residential lighting circuits are subjected to severe transients, as well as any electronic equipment connected to those circuits. As a result, the solid-state equipment in your home is subject to damage from voltage spikes if not properly protected.

suppression of transients

There are several ways to suppress voltage transients, and depending on the circuit application,



Transients are capable of destroying solid-state components such as IC's, rectifiers, and transistors (even power transistors usually assumed to be protected by heatsinks). To protect these sensitive components from voltage transients, it's necessary to use some type of energy absorbing device such as the metal oxide varistors shown in the photo. These are the four round shaped components on the right that look like disc capacitors. Commercial solid-state equipment such as the well designed power supply in the background may be protected by installing a varistor on the line side of the power transformer. See text.

some devices are better than others. Some of the devices available for you to choose from include metal-oxide varistors, power zeners, and short-circuiting devices such as spark gaps and electronic crowbar circuits.

Metal-Oxide Varistors. These dynamic resistance devices feature both low cost and small size, and are capable of dissipating a considerable amount of energy for a short period of time. One source for metal-oxide varistors is the General Electric Company; their registered trade name for these devices is GE-MOV. These varistors are available from most electronics supply houses.

If you are going to use these devices, I would recommend that you obtain a copy of GE's "Transient Voltage Suppression Manual," (\$2.50 from GE, Semiconductor Products Department, Electronics Park, Syracuse, New York 13201). This manual is a complete guide to the proper application of varistors.

Since varistors are bi-lateral devices, they may be used in both ac and dc applications. In low-voltage dc applications, however, they may not provide adequate protection due to their soft clamping characteristics. They are generally more suitable for ac line voltages, and consequently are excellent in suppressing transients on the line side of equipment power supplies. An example is shown in fig. 2.

Power Zener. While varistors may exhibit soft characteristics at low dc voltages, power zeners can clamp very hard and fast at those voltages. Also, high transient currents do little to raise the clipping

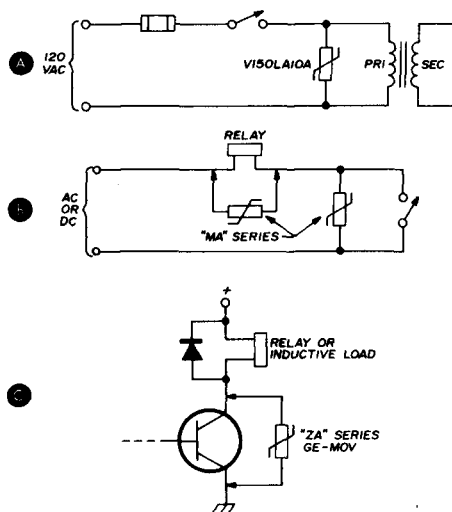
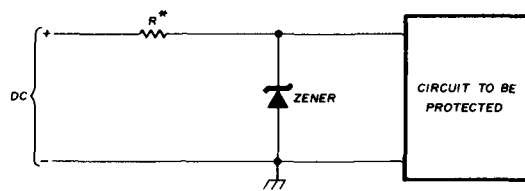

fig. 2. Application of commercial varistors will help eliminate line transients. The L series of GE-MOV varistors can handle up to 2750 amps (transient) and peak voltages from 95 to 1000 volts RMS (A). The MA series varistors are used primarily in low power applications, either ac or dc. In B, they're used to prevent contact arcing and line noise. To prevent transients while switching inductive loads, the ZA series of varistors are connected across the switching transistor as shown in C.



* • LOW VALUE RESISTOR OR FUSE

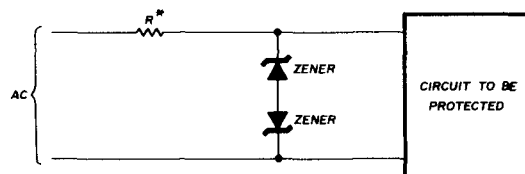

fig. 3. Instead of using commercial varistors, zener diodes can also be used to provide protection against voltage transients. The two examples show ways in which zeners can protect both ac and dc circuits. For the dc circuit, the zener is rated at a voltage greater than the dc bus, but less than the maximum voltage of the circuit to be protected. In an ac application, they should be rated at slightly greater than the peak ac value.

level of most zeners, provided ratings are not exceeded. The most effective way to apply zeners is with some amount of series resistance to safely limit the current. Two schemes for protecting both ac and dc circuits are shown in fig. 3.

Short Circuit Methods. At first, this approach may seem contrary to normal applications. After all, a short circuit in most cases is a very undesirable situation. However, if it is properly controlled and occurs for very short periods of time (microseconds), the end result can be very beneficial in suppressing transients.

The two most commonly used devices in this category are spark gaps (both open and sealed units) and electronic crowbar circuits. The first is often used by amateurs for antenna applications, while the second is usually too complex for most hobby applications. The spark gap is adjusted to arc at a voltage above a certain level, effectively grounding the transient energy. Which method or combination of methods you choose, will depend on the application and what you are attempting to protect.

The best approach is to buy transient suppressors only in component form and apply them yourself using the guidelines in this article. Only then can you be assured of applying these useful devices for their intended purpose — protecting solid-state devices from voltage transients.

reference

1. IEEE Transactions on Power Apparatus and Systems, Vol. PAS-89, 1970.

ham radio

WHERE RELIABILITY & ACCURACY COUNT

INTERNATIONAL CRYSTALS

70 KHz to 160 MHz

HOLDER TYPES

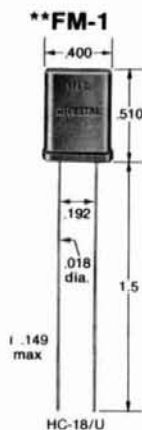
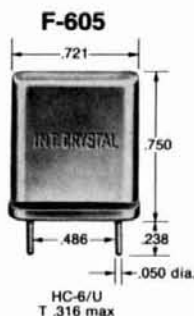
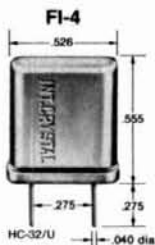
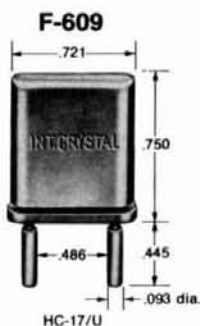

**International
Crystal Manufacturing Co., Inc.
guarantees**

**every crystal against defective
materials and workmanship for
an unlimited time, when used in
equipment for which they were
specifically made.**

CRYSTAL TYPES

- (GP) for "General Purpose" applications
- (CS) for "Commercial" equipment
- (HA) for "High Accuracy" close temperature tolerance requirements

International Crystals are available from 70 KHz to 160 MHz in a wide variety of holders.

WRITE FOR INFORMATION

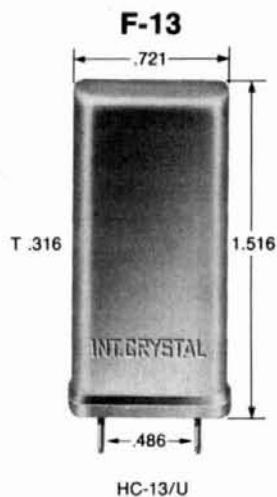
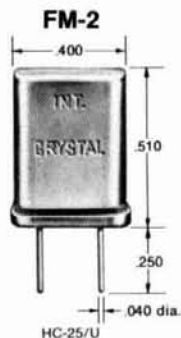

INTERNATIONAL CRYSTAL MFG. CO., INC.
 10 North Lee, Oklahoma City, Oklahoma 73102
 405/236-3741



DRAKE TR-7

continuous coverage

Introducing a remarkable engineering breakthrough...



Designed and
manufactured
in U.S.A.

Models shown
are Drake
TR-7/DR-7
with RV-7
and MS-7

0-30 MHz

continuous coverage reception capability

160-10 Meters

Amateur Band transmission, including capability for
MARS, Embassy, Government, and future band expansions*

*The Drake TR-7 System significantly
advances the technology of worldwide
radio communications and unfolds
an entirely new state of the art.*

solid state synthesized hf system

In 1963 Drake led the way by producing the first commercially available transceiver that employed the now widely copied 9 MHz i-f frequency. Even today, 15 years later, many major competitive transceivers are still being introduced using i-f's in this range.

In 1978 Drake leads the way again by developing the first commercially available amateur transceiver that uses a 48 MHz i-f, through the technique of "Up-Conversion." This system greatly improves image and general coverage performance, and will be copied in the years to come. With Drake, you can join the new state of the art today!

The design philosophy behind the new Drake "7 system" has created a most sophisticated system concept, extending from engineering to the visual appearance of the system and each of its parts.

The TR-7 System is the result of one of the most extensive engineering and development programs in the history of the R. L. Drake Company, and provides the user with many innovative design features.

With the excellent design of its front panel and controls, the system is simple and straightforward to operate—makes state of the art performance a pleasure.

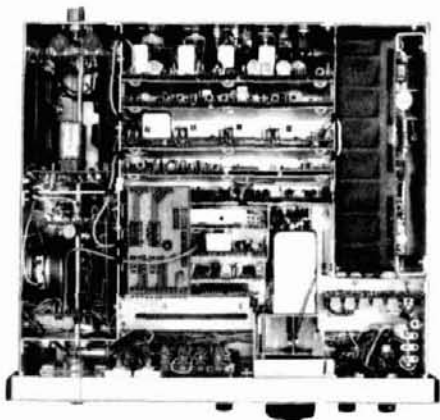

*Note: Out-of-band transmitter coverage for MARS, Government, etc. is available only in ranges authorized by the FCC, Military, or other government agency for a specific service. Proof of license for that service must be submitted to the R. L. Drake Company, including the 500 kHz range to be covered. Upon approval, and at the discretion of the R. L. Drake Company, a special range IC will be supplied for use with the Aux-7 Range Program Board. Prices quoted from the factory. See operator's manual for details.

Broadband, Solid State Design—100% solid state throughout. All circuits are broadbanded so there is no need for preselection tuning or transmitter adjustments of any kind.

Synthesized/PTO Frequency Control—A Drake exclusive: Special high performance synthesizer, combined with the famous Drake PTO, provides smooth, linear tuning with 1 kHz dial and 100 Hz digital readout. 500 kHz up/down range switching is pushbutton controlled.

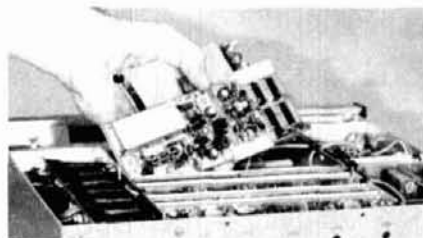

Continuous, Wide Range Frequency Coverage—The TR-7/DR-7 provides reception from 1.5 thru 30 MHz—continuously, and zero thru 30 MHz continuously with the optional Aux-7 Range Program Board. The highly advanced Drake Synthesizer makes this possible, and is an industry first. The TR-7/DR-7 provides transmit coverage for all Amateur Bands 160 thru 10 meters. With the optional Aux-7 Range Program Board, diode-programmable out-of-band transmit coverage is available for MARS.

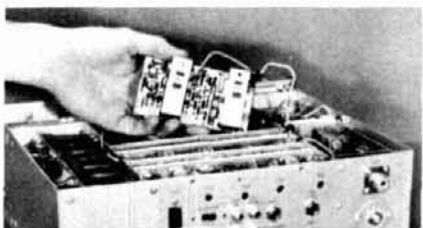

Embassy, Government, and future band expansions in the range 1.5 thru 30 MHz.* The Aux-7 Board provides 0 thru 1.5 MHz receive coverage and crystal-controlled fixed channel operation for Government, Amateur, or semi-commercial applications anywhere in the hf range. The TR-7 w/o DR-7 and Aux-7 provides coverage of the Amateur Bands 160 thru 15 meters and the 28.5-29.0 MHz range of 10 meters. The Aux-7 Range Program Board is also useable in the standard TR-7 for extra range coverage as noted.

State of the Art Receiver Design—The Drake TR-7 introduces another industry first for amateur transceivers: "Up-Conversion," in combination with a special uhf high level double balanced mixer for superior strong signal handling, spurious and image response performance. The first i-f of 48.05 MHz places images well outside the receiver passband, and provides for true general coverage operation without i-f gaps.

True Passband Tuning—The TR-7 employs the famous Drake Full Passband Tuning instead of the limited

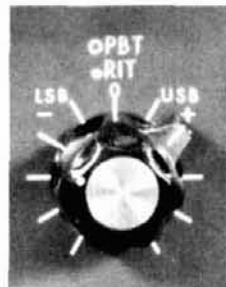

range "i-f shift" found in some other units. The Drake System tunes from the top edge of one sideband, through center, to the bottom edge of the other sideband. In fact, the range is even wider

to accommodate RTTY. Full passband tuning greatly improves receiving performance in heavy QRM.

(TR-7 features continued on next page)

DRAKE TR-7 solid state continuous coverage synthesized hf system

Unique Independent Receive Selectivity

—Optional receiving selectivity filters can be installed internally and pushbutton-selected from the front panel. These may be selected independently of transmit mode and provide optimum response for various conditions of ssb, cw, RTTY, and a-m. You may also transmit cw while receiving ssb, or vice versa, or even transmit one sideband while receiving the other. The standard filter is 2.3 kHz for ssb. You may choose from optional 300 Hz, 500 Hz, a special 1.8 kHz for crowded ssb, or 6 kHz filter for a-m.

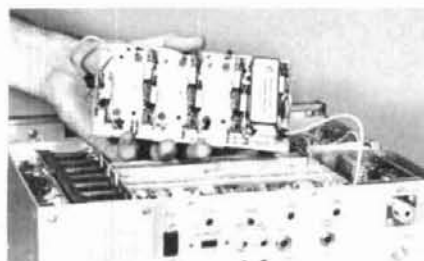

Effective Noise Blanker—This accessory is custom engineered to provide true blanking performance.

Special High Power Solid State PA

—A Drake custom-designed diagonal heat sink provides for an internally mounted power amplifier with nothing mounted outboard subject to physical damage. The unique air ducting effect of this amplifier allows an optional rear-mounted fan to provide continuous duty on SSTV/RTTY. Continuous ssb/cw operation is available without the fan, due to the excellent heat sink design. The optional Drake PS-7 Ac Supply is rugged,

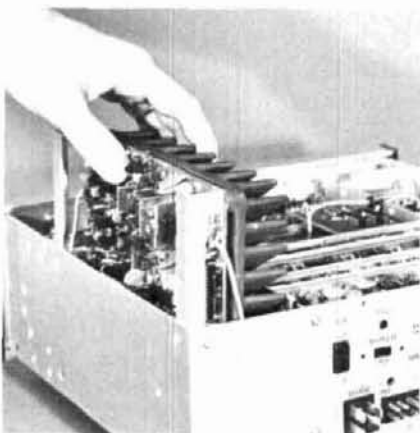

rated for continuous duty, and will easily handle power requirements. The System is rated 250 watts input—in any of its modes. Fully VSWR protected.

TR-7 Internal Test Facilities—As well as the standard "S" meter function, the TR-7 metering includes a built-in rf Wattmeter/VSWR Bridge. Also, the DR-7 digital counter reads frequencies to 150 MHz for test purposes. Access to the counter is from the rear panel.

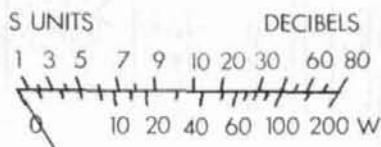

Receiver Incremental Tuning (RIT)

—Complete RIT flexibility is provided for both the TR-7 and RV-7 remote VFO for maximum convenience. The RV-7 also includes a special "spot" function for easy zero beating.

Model 1337 Drake TR-7 Transceiver	\$ 886.00
Model 1530 Drake DR-7 General Coverage/ Digital Readout Board	186.00
Model 1336 Drake TR-7/DR-7 General Coverage Digital R/O Transceiver	1072.00
Model 1338 Drake RV-7 Remote VFO	156.00



Model 1502 Drake PS-7 120/240V Ac Supply includes special wide range voltage and frequency capability. Operates from any nominal line voltage (90-132 V/ 180-264 V; 50-60 Hz) ideal for overseas	\$166.00
Model 1536 Drake Aux-7 Range Program Board	38.00
Model 1531 Drake MS-7 Matching Speaker	33.00
Model 1537 Drake NB-7 Noise Blanker	74.00
Model 1529 Drake FA-7 Fan	24.00
Model 7021 Drake SL-300 Cw Filter, 300 Hz	49.00
Model 7022 Drake SL-500 Cw Filter, 500 Hz	49.00
Model 7023 Drake SL-1800 Ssb/RTTY Filter, 1.8 kHz ..	49.00
Model 7024 Drake SL-6000 A-m Filter, 6.0 kHz	49.00
Model 1335 Drake MMK-7 Mobile Mounting Kit	to be announced
Model 1538 Drake MN-7 250 Watt 160-10 Meter Antenna Tuner with Rf Wattmeter and complete switching functions	165.00
Model 1514 Drake WH-7 Hf Wattmeter/VSWR Bridge	89.00

The Drake State of the Art unfolds an entirely NEW Art of the States!

To receive a FREE Drake Full Line Catalog, please send name and date of this publication to:

R. L. DRAKE COMPANY



540 Richard St., Miamisburg, Ohio 45342
Phone: (513) 866-2421 • Telex: 288-017

Western Sales and Service Center, 2020 Western Street, Las Vegas, Nevada 89102 • 702/382-9470

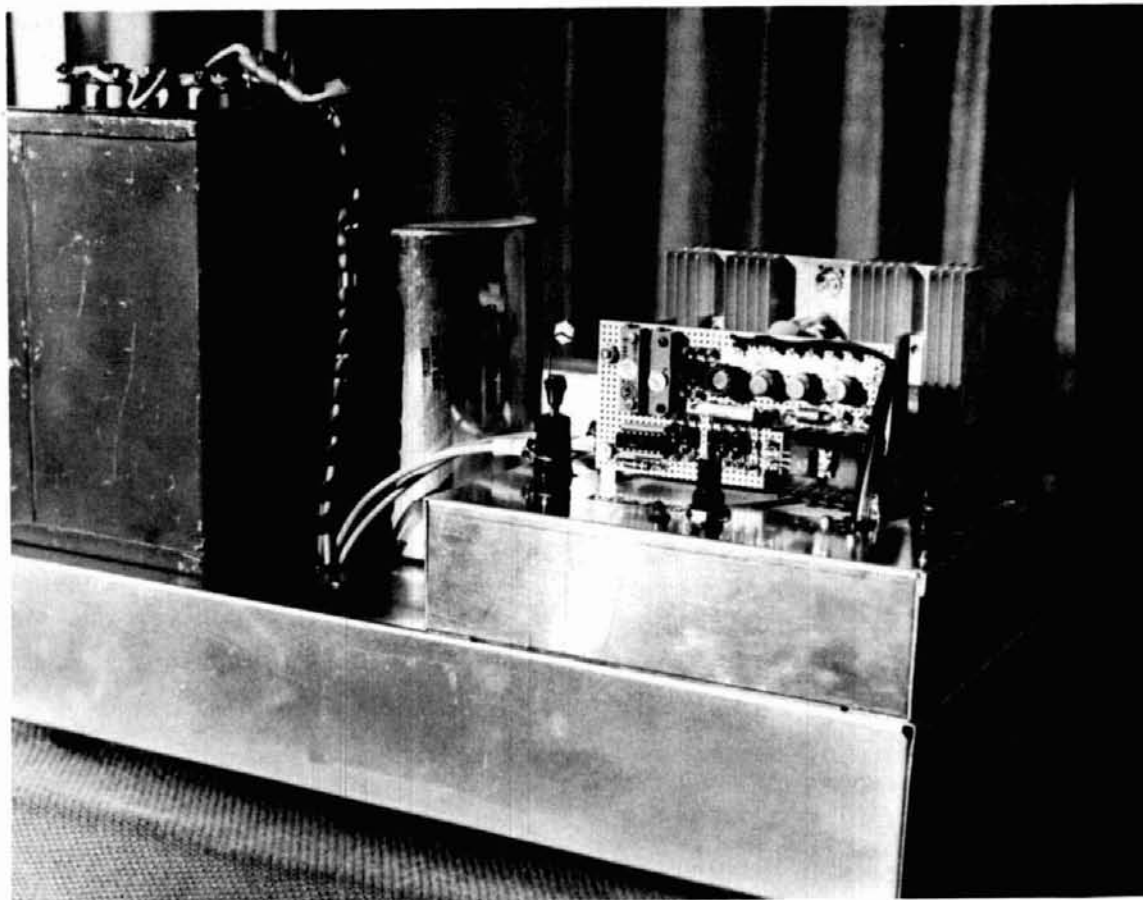

instantaneous- shutdown high-current regulated power supply

Protect both the
new circuit
and power supply
by using
this high-current
instantaneously shutdown
power supply

Anybody who builds a semiconductor circuit is faced with a potentially disastrous problem — what will happen when power is applied to the circuit? A short circuit could be catastrophic, for both the power supply and the newly-built circuit.

A high-current regulated power supply will continue to supply power, even with a short circuit, until one of the following events takes place.

1. The short circuit clears itself.
2. A semiconductor failure occurs (either the silicon or metal leads melts).
3. The power supply is damaged.

By Alan Nusbaum, W6GB, Dalmo Victor Operations, Bell Aerospace Textron, Division of Textron, Inc., 1515 Industrial Way, Belmont, California 94002

4. A fuse is blown, but usually too late to protect the circuit.
5. The power supply contains an extremely fast over-current sensing circuit that will cut off the current in less than 200 nanoseconds.

This article will describe just such an over-current shut-down circuit.

Over the past few years, there have been some new and novel voltage-regulator devices which will tolerate shorts or over-current loads by application of current fold-back circuits or thermal shutdown. Other versions which use a crow-bar device rely on blowing a fuse in the power supply primary. This method, however, is rather brutal treatment, and is often fatal to the pass transistor. I feel that a "graceful" but high-speed shutdown circuit is necessary to protect both the newly developed circuit and the power supply. Essentially, it must shutdown and not

As seen in **fig. 1**, a PNP pass transistor is driven by a complimentary NPN monolithic Darlington. The Darlington in turn is current driven by a medium-gain transistor which acts as a voltage error detector. This form of regulator has proven to be very sensitive and reliable in that it will hold to within 30 mV from no load to a 15 ampere load, with less than 10 mV ripple at full load.

The shutdown portion of the circuit uses an SCR to rob the base current from the Darlington pair. When the SCR is triggered from the voltage comparator, the point between the 470-ohm resistor and CR2 is effectively grounded, reducing the output voltage to zero. U1, a μ A311 voltage comparator, is used to sense the voltage drop caused by over-current across the two 0.1-ohm resistors. The noninverting input of the comparator is fed from a separately regulated source (U2). The inverting input is the actual output voltage, after it has been appro-

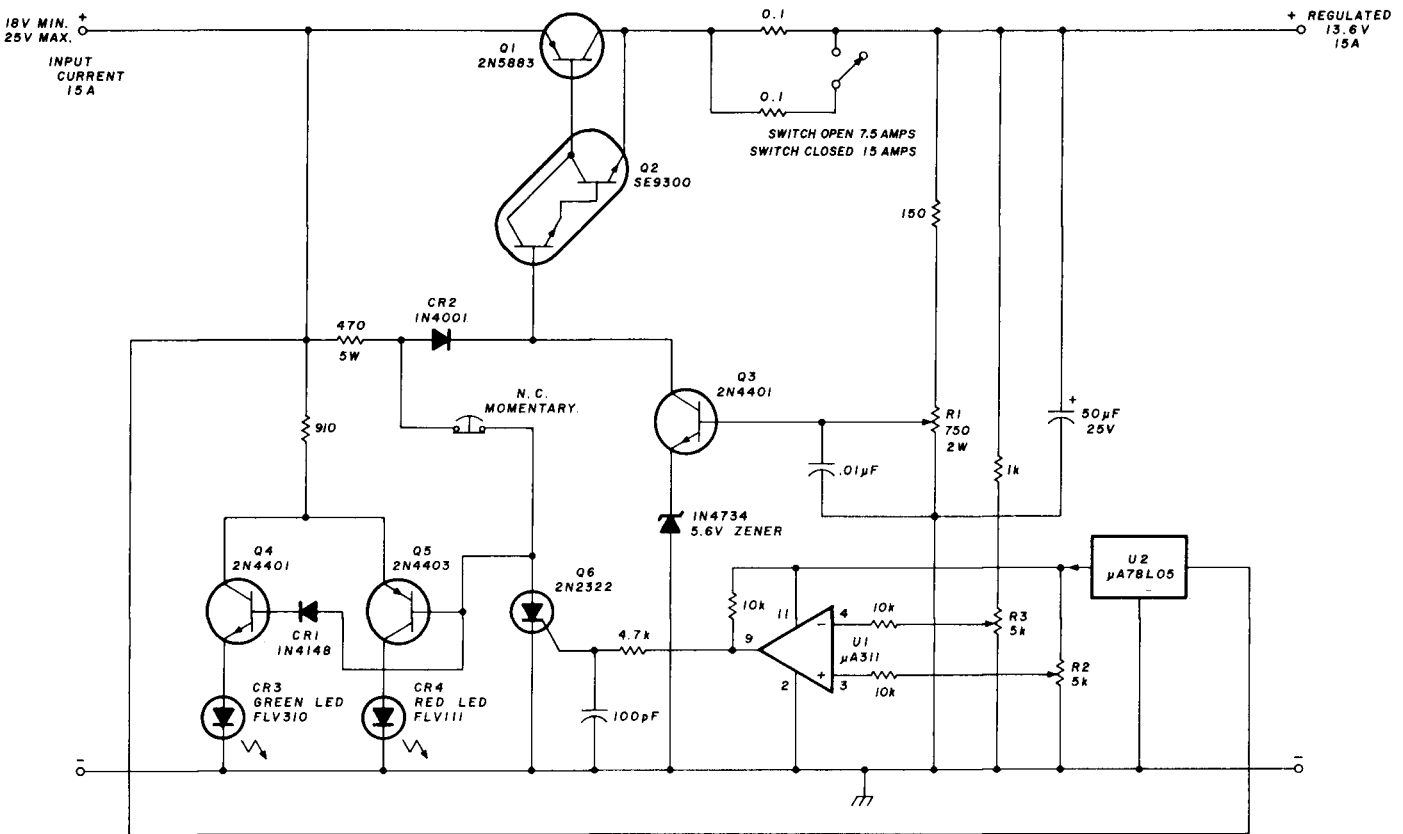

fig. 1. Schematic diagram of the high-current power supply. The separate 5-volt regulator is used to bias one input of the voltage comparator. The SCR is fired when the second leg of the voltage comparator detects a drop across the 0.1 ohm resistors. S1 is a normally-closed momentary type switch. Q1 must have an adequate heatsink (see text).

be allowed to restart after some pre-determined current level has been exceeded.

This power supply contains a high-gain error voltage control circuit and a voltage comparator that functions as a high-speed switch.

When an under-voltage condition is created by over current, the output of the comparator will go high, turning on the SCR. To restart the regulator, it is necessary to momentarily disconnect the anode of the SCR, after clearing the over current

condition. The green and red LEDs are used to indicate the status of the regulator, with red indicating that the SCR has been fired.

construction

The actual construction of the power supply is straightforward. However, the pass transistor must have an adequate heatsink. The power dissipated is

$$W_{diss} = (V_{in} - V_{out}) + V_{CEsat} \times I_{CE}$$

To setup and adjust the supply, all components are connected with the exception of the SCR, Q6. A 100-ohm, 100-watt adjustable resistor can be used as a load. With the load resistor set for maximum resistance, the power supply is energized and R1 is adjusted for the desired output voltage (13.6 volts). An oscilloscope can also be connected to determine if there are any oscillations on the output waveform. If so, a 27-pF capacitor connected from collector to emitter of Q3 should eliminate the problem.

With a high-impedance voltmeter connected to the wiper arm, R2 should be adjusted to provide 2 volts to the comparator. This is the reference set point and should not be disturbed once set. After moving the voltmeter to the wiper of R3, this potentiometer should be set for a reading of 2.5 volts. With the meter still connected to R3, change the tap on the load resistor to the 50-ohm point. The 2.5 volt reading should not change.

The final step consists of checking the action of Q6. With the power supply switched off, connect the SCR. Also disconnect the load resistor and set the slider for a resistance of 1 ohm, but do not reconnect the resistor at this time. After re-energizing the supply, the red LED should be on; pressing the arming switch will turn on the green LED while extinguishing the red. If the LEDs do not function as indicated, remove the SCR and check the voltage on R3 to ensure that it's no lower than 2.5 volts. Also, check the voltage on the output of the comparator; it should be less than 100 millivolts. With the SCR installed and the circuit armed, the gate of Q6 should also measure less than 100 millivolts.

To test the circuit, momentarily connect the 1-ohm load resistor to the supply output. The shutdown circuit should operate instantaneously, and the red LED should come on. You should test this action several times to verify consistent shutdown.

At one ohm, the load current is 13.6 amps, but you can adjust R3 to actuate the shutdown at any current you desire. However, the voltage from R3 must not be lower than R2's voltage or the circuit will lock up in the fired mode. This system has been in use for over a year and has operated flawlessly during the entire time, even when powering tube-type mobile transmitters.

ham radio



RF Power Meter — General Microwave Model 451, electrically identical to HP430C \$34.95

Bolometer with purchase of Power Meter only \$45.00

Audio Compressor AN/GSA-33 - Five identical plug-in compressor amps with power supply in 19 inch rack. All solid state, 600Ω in & out, great for auto patch and phone patch. Weighs less than 30 lbs. Built like a battleship. \$34.95



POWER SUPPLIES

28 Volt, 18 Amp Regulated Power Supplies (110V in) \$75.00
12 Volt, 18 Amp Regulated Power Supplies (110V in) \$85.00
Dual 300V D.C. 1 amp fully metered \$85.00

RECEIVERS

Collins 651F-1, 2 to 30 MHz in 100 cycle steps, digital tuning, USB/LSB/ISB. Stability: 1 part in 10⁸. Completely remote controlled, with all racks, connectors, control head. \$1400.00
R-388/51J — Collins 0.54 to 31 MHz \$375.00
R-390A — 0.54 to 31 MHz, overhauled complete \$595.00
Astrocom SR201, 30-300 MHz, all solid state \$450.00
RACAL Model 6217A, 980 kHz, 32 MHz, All Solid State, takes about 3 inches of rack space, digital tuning \$1600.00
LTV G111 Panoramic Recvr includes CRT display, 100-150 MHz with converters. Will make a fine spectrum analyzer. \$150.00



TMR-5 with front end plug-ins to cover 105-140 MHz and 200-260 MHz. \$250.00
 We have complete documentation for all TMR-5 series including plug-ins.

CEI type 415, 60-250 MHz, all solid state, modular constr., xtal controlled, 4 channels. Incredible value. \$85.00

635V-1 Collins Preselector band pass Filters — They're back! 2 to 3 MHz, 1 kHz steps, with copy of manual and rack and connector. \$275.00

SX-115 Immaculate with speaker and manual. \$450.00

ANWRR2, 2-30 MHz, synthesized or continuous tuning, completely bench checked. \$600.00

TEST EQUIPMENT

Bird 6835 Termination Wattmeter complete RF Assy. — NEW! 1.2 KW, 600 watts, 120 watts full scale. You add oil and meter. \$95.00

SPECIAL: Micromatch in-line wattmeters, complete guts, less meters, good to 500 MHz. You add 50μA meter. Removed from equipment. \$24.95

HP400DR Audio VTVM — NEW \$125.00

Solartron DA410 Transfer Function Analyzer with manual. \$475.00

Weinschel 693-1 Power Attenuators, 30 watt avg., 10KW peak. \$65.00

HP764D Dual directional coupler, 200-500 MHz. \$100.00

FXR, 20 dB directional coupler, 200-400 MHz. \$75.00

HP340B Noise Figure Meter with HP343A Noise Source \$275.00

HP608D, 10-420 MHz. \$425.00

Crystal Detectors, HP-423A or equivalent. \$25.00

TRANSMITTERS

Collins KWT6-6/URC32 — 2-30 MHz, 1 kHz steps, complete xcvr, 500 watt PEP output, 500 watt CW output, AM capability. Complete and running. \$1850.00



T/T to Pulse Converter — requires 12-24 VDC \$34.95

Standard T/T pad mounted in a sturdy steel case incl. 2 volume pots & 1 push button labeled "Stereo" - Also has 2 phone jacks for headphones, microphone, etc. Will make a fine control head. \$24.95



Note: We have a crossbar switch and driver electronics which when used with the above board, will make a complete remote control system. Will dicker or swap.

Wanted: Documentation for AN/WRR-2, plug-ins and IF Amplifiers for TMR-5.

DISC-CAP, 1434 REYNOLDS ST. AUGUSTA, GA. 30902



404-722-1121

Ga. Residents - add State Sales Tax. Unfortunately, Disc-Cap can only service U. S. customers.

command function debugging circuit

This device takes
command information
from standard
PLL function decoders
and applies
a short time delay
to provide debugged
control commands

Our club had just finished installing an autopatch, exhausting all available funds, when the need for a better command decoder became evident. Each of the users had noted voice falsing of the decoder, and it was enough of an annoyance to be serious. More than once a telephone conversation had been terminated by a voice peak.

The investigation of causes and cures ran the gamut, until we finally decided that a fraction of a second delay on the command-function decoders would probably solve the problem. A number of

designs were passed around and considered, and a few almost built, but the one described here was finally implemented — for three reasons: one, it works; two, it costs nothing to build; and three, it was built before any of the others. The design was based on the available components, and on the assumption that it might be necessary to drive a number of different types of loads. These considerations led to the use of transistor switches and reed relays to provide the outputs.

circuit description

The output circuitry from the tone decoder is shown in fig. 1. In our repeater, the debugging cir-

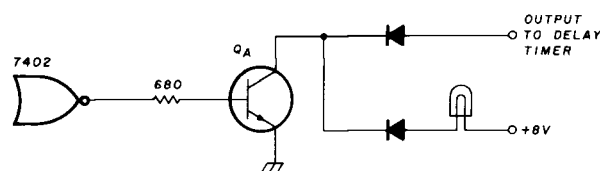

fig. 1. Output switching from the autopatch, prior to the installation of the debugger.

cuit was added without making any modifications to the autopatch. As shown in fig. 2, the debugging circuit consists of two portions, the transistor switches are wired to provide V_{CC} to their respective reed relays and the delay circuit which provides the ground return for the relay coils. Since only one relay

By J. Thomas Norman, WA7HFY, 1002 South 8th Street, Laramie, Wyoming 82070

is actuated at a time, only a single delay circuit is required. The diodes at the input of the delay timer form a multiple-input OR gate to actuate the delay after any digit has been decoded.

The timer itself is not very critical, especially since four different transistor types were used (even an unidentified NPN transistor). In its quiescent state, Q1 is biased on, charging C1 to approximately 8 volts. This level maintains Q2 and Q3 on, and Q4 off. When a function is decoded, Q1's base is effectively grounded back through the two diodes and Q_A. With the transistor now cut off, C1 will discharge through R3.

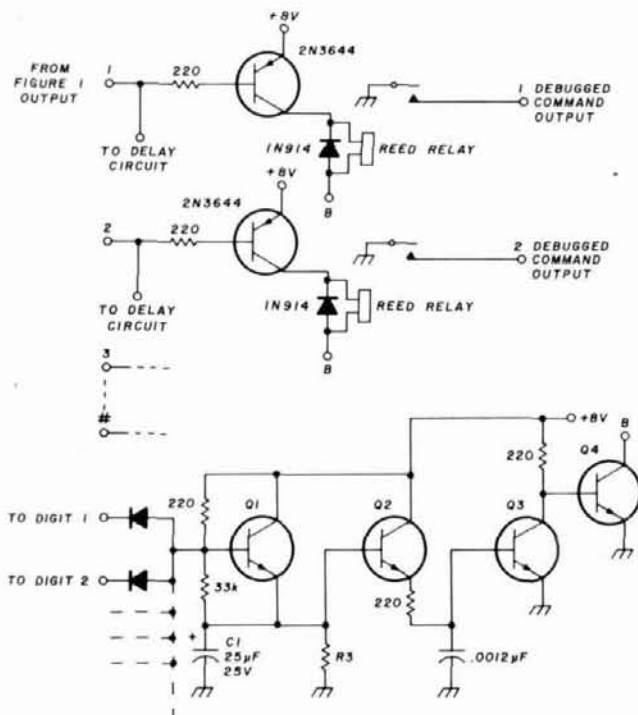

fig. 2. Schematic diagram of the add-on debugging circuit. Instead of the commands being controlled by transistor switches, they are controlled by reed relays. The delay portion of the circuit prevents the relays from picking up on noise spikes. The transistors can be almost any NPN type. R3 should be adjusted for the desired delay.

The value of this resistor can be adjusted for the desired amount of time delay, in our case approximately 0.1 second. When the voltage on the base of Q2 drops below about 1.2 volt, Q2 and Q3 are cut off and Q4 is turned on. With Q4 on, the reed relay is actuated, but when a noise spike is decoded as a pulse, the 2N3644 is turned on; since most noise pulses are very short in duration, they do not allow the timer to complete the circuit to actuate the relay.

ham radio

FREQUENCY COUNTERS

BY POPULAR DEMAND — we are continuing to offer **FREE** with any purchase of \$99 or more from ad or flyer, a Fairchild clock module FCS-8100A (suggested retail price \$20).



Look at these Summer Specials

COMPLETE KITS: CONSISTING OF EVERY ESSENTIAL PART NEEDED TO MAKE YOUR COUNTER COMPLETE. **HAL-600A** 7-DIGIT COUNTER WITH FREQUENCY RANGE OF ZERO TO 600 MHz. FEATURES TWO INPUTS: ONE FOR LOW FREQUENCY AND ONE FOR HIGH FREQUENCY; AUTOMATIC ZERO SUPPRESSION. TIME BASE IS 1.0 SEC OR .1 SEC GATE WITH OPTIONAL 10 SEC GATE AVAILABLE. ACCURACY $\pm .001\%$. UTILIZES 10-MHz CRYSTAL 5 PPM.

COMPLETE KIT... \$149... \$129

HAL-300A 7-DIGIT COUNTER WITH FREQUENCY RANGE OF ZERO TO 300 MHz. FEATURES TWO INPUTS: ONE FOR LOW FREQUENCY AND ONE FOR HIGH FREQUENCY; AUTOMATIC ZERO SUPPRESSION. TIME BASE IS 1.0 SEC OR .1 SEC GATE WITH OPTIONAL 10 SEC GATE AVAILABLE. ACCURACY $\pm .001\%$. UTILIZES 10-MHz CRYSTAL 5 PPM.

COMPLETE KIT... \$124... \$109

HAL-50A 8-DIGIT COUNTER WITH FREQUENCY RANGE OF ZERO TO 50 MHz OR BETTER. AUTOMATIC DECIMAL POINT, ZERO SUPPRESSION UPON DEMAND. FEATURES TWO INPUTS: ONE FOR LOW FREQUENCY INPUT, AND ONE ON PANEL FOR USE WITH ANY INTERNALLY MOUNTED HALTRONIX PRE-SCALER FOR WHICH PROVISIONS HAVE ALREADY BEEN MADE. 1.0 SEC AND .1 SEC TIME GATES. ACCURACY $\pm .001\%$. UTILIZES 10-MHz CRYSTAL 5 PPM.

COMPLETE KIT... \$124... \$109

ATTENTION RADIO CLUBS

For club or group projects, request FREE information about our DISCOUNTS on any of the HAL-TRONIX kits. Discounts range from 10-25%, depending upon the quantity needed. We are experienced in supplying kits in volume quantities to schools, laboratories, clubs, and common-interest groups. Nobody beats HAL-TRONIX quality and price. Just try us and see for yourself.



FROM HAL-TRONIX

DELUXE 12-BUTTON TOUCH-TONE ENCODER KIT utilizing the new ICM 7206 chip. Provides both VISUAL AND AUDIO indications! Comes with its own two-tone anodized aluminum cabinet. Measures only 2 3/4 x 3 3/4". Complete with Touch-Tone pad, board, crystal, chip and all necessary components to finish the kit.

PRICED AT... \$29.95

For those who wish to mount the encoder in a hand-held unit, the PC board measures only 9/16" x 1 1/4". This partial kit with PC board, crystal, chip and components.

PRICED AT... \$14.95

PRE-SCALER KITS

HAL-0-300PRE... \$19.95 (Pre-drilled G10 board and all components)

HAL-0-300P/A... \$29.95 (Same as above but with preamp)

HAL-0-600PRE... \$39.95 (Pre-drilled G10 board and all components)

PRE-BUILT COUNTERS AVAILABLE

HAL-600A... \$229.00

HAL-300A... \$199.00

HAL-50A... \$199.00

ALLOW 4- TO 6-WEEK DELIVERY ON PRE-BUILT UNITS.



"HAL"
HAROLD C. NOWLAND
W8ZXH

HAL-TRONIX

PO BOX 1101, SOUTHGATE, MI 48195
PHONE (313) 285-1782

SHIPPING INFORMATION:

ORDERS OVER \$15.00 WILL BE SHIPPED POSTPAID EXCEPT ON ITEMS WHERE ADDITIONAL CHARGES ARE REQUESTED. ON ORDERS LESS THAN \$15.00 PLEASE INCLUDE ADDITIONAL \$1.00 FOR HANDLING AND MAILING CHARGES. SEND SASE FOR FREE FLYER.

the super-compact alda 103

only 3 1/4" high x 9" wide x 12 1/2" deep • less than 8 1/4 pounds

ALDA 103, the trim little powerhouse with incredible performance for the price! ALDA 103 provides a full 250 watts PEP input for SSB operation, and 250 watts DC input for CW. And when it comes to performance, ALDA 103 is the hottest little transceiver going — all solid state, totally broadbanded and super-stable VFO.

Ideal first transceiver for brand new novices! You'll want a full-capability CW/USB/LSB unit with all the power and performance you can use. ALDA 103 gives you 250 watts DC input for CW, the maximum allowable power for your novice license. When you upgrade to technician, you've got 2 bands

for CW operation. And with your general license, just plug in your mic and use the ALDA 103's full 250 watts PEP on SSB!

Perfect second or mobile unit for seasoned hams! If you're looking for a super-sharp, compact unit to use in your car or boat, ALDA 103 will live up to your expectations. Absolute worst case sensitivity 0.5 μ V for 10 dB S+N/N — a must for mobile operation. Receiver audio output of 3 watts minimum — another must. Also, very low receiver power drain of only 5.5 watts — that's 0.4 amps at nominal 13.8 VDC including power for dial and meter lamps!



GENERAL SPECIFICATIONS

Semiconductors: 39 diodes, 23 transistors; 11 integrated circuits

Power Requirements: Nominal 13.8 VDC input at 15 amps, negative ground only

Power Consumption: Receive — 5.5 watts (includes dial and meter lamps); Transmit — 260 watts

Dimensions: 3-1/4" high x 9" wide x 12-1/2" deep (82.55 mm x 228.6 mm x 317.5 mm)

Weight: 8-1/4 lbs. (3.66 kg)

PERFORMANCE SPECIFICATIONS

Frequency Range: 80 meter band — 3.5 to 4.0 MHz
40 meter band — 7.0 to 7.5 MHz
20 meter band — 14.0 to 14.5 MHz

Modes: CW, USB, LSB

RF Input Power: SSB — 250 watts PEP nominal
CW — 250 watts DC maximum (adjustable)

Transmitter:

Antenna Impedance: 50 ohm, unbalanced

Carrier Suppression: Better than -45 dB

Side-Band Suppression: Better than -55 dB at 1000 Hz

Distortion Products: Better than -26 dB
500 to 2500 Hz

AF Response: Harmonics better than -45 dB below 30 MHz; better than -60 dB above 30 MHz

Spurious Radiation: Less than 100 Hz drift per hour (from a cold start at room temperature)

Frequency Stability: High impedance 3000 ohm

Microphone:

Receiver:

Sensitivity: Better than 0.5 watts audio output for 0.5 μ V input

Signal-to-Noise Ratio: Better than 10 dB S+N/N for 0.5 μ V input

Image Ratio: Better than -60 dB (typical with respect to 0.5 μ V input: 80 meters — -130 dB; 40 meters — -100 dB; 20 meters — -75 dB)

IF Rejection: Better than -70 dB (typical with respect to 0.5 μ V input: 80 meters — 110 dB; 40 meters — 80 dB; 20 meters — 75 dB)

Intermodulation Intercept Point: Better than 10 dBm

Selectivity: 2.5 kHz — 6 dB; 5.0 kHz — 60 dB

Audio Output Power: More than 3 watts

Audio Distortion: Less than 5% at 3 watts

\$495

including microphone and mobile mount, too.

OPTIONS & ACCESSORIES

Noise Blanker — Model No. PC 701 **\$29.95**

100 kHz and 25 kHz Dual Crystal Calibrator — Model No. PC 801 **\$14.95**

Portable Power Supply — Model No. ALDA PS 115: average duty 15 amp unregulated; input — 115/230 VAC, 50/60 Hz; output — 13.8 V nominal at 15 amps **\$79.95**

Heavy Duty Power Supply — Model No. ALDA PS 130: output — regulated 30 amp at 13.8 VDC; input — 115/230 VAC, 50/60 Hz **\$149.95**

alda communications, inc. 215 Via El Centro Oceanside, CA 92054 (714) 433-6123

EUROPE Contact Datacom, Box 442, S-194 04 Uplands Vasby, Sweden

EXCEPT FRANCE Poussieigues Diffusion Electronique Sarl, 89 Bis Rue De Charenton — 75012 Paris

ALDA 103 is completely manufactured in the U.S.A.

no-cost grid-dip meter

How to use no-cost parts
salvaged from an
old broadcast radio
to build a grid dipper
that tunes
from 1 to 90 MHz

In these days of shortages and skyrocketing prices it seems improbable that anything could be free. However, except for a little spray paint, the instrument described here can, in truth, be free. Originally it was built for novice use to enable them to prune antenna systems, and to serve as an absorption wavemeter to insure output was on the correct band. It has proven so stable and reliable, however, that it can also serve a more experienced ham as a rugged instrument for general purpose work, and where considerably more output is needed than is available from solid-state dippers.

The frequency range is limited to approximately 1-90 MHz due to the variable capacitor I used for

tuning. If a fairly clean capacitor is used — one which is not corroded and has good wipers — tuning will be unusually smooth and free from spurious dips. From the photographs it is obvious that it is more bulky than most commercial dippers. The vacuum tube protruding from the end may not be pretty, but this arrangement contributes substantially to frequency stability.

The schematic, **fig. 1**, shows the basic circuit. The tuning capacitor is the type commonly used in older five-tube ac-dc broadcast sets. If you have no 150-volt supply easily available, you can add a series resistor in the B+ line. This resistor should be about 50k for each 100 volts higher than the desired 150-volt supply. For instance, if the dipper is to be run from a 350-volt supply, the supply voltage is 200 volts too high, so a 100k dropping resistor would be chosen. It can be any value from 82k to 120k, and should be rated at 2 watts. The heater voltage can probably be picked off the same supply.

If you don't have a milliammeter available, you can use a 1000 ohms-per-volt multimeter on the 1.0- or 1.5-volt scale, or you can install a 2.2k resistor in place of the meter and read across this resistor with a 20,000 ohms-per-volt multimeter or vtvm on a 1.0- to 1.5-volt scale. This hookup is shown in **fig. 2**.

If you want to modulate the dipper, you can add the simple circuit shown in **fig. 3**. This transistor oscillator is powered by the dipper grid current and grid modulates the dipper. This makes it easier to locate the dipper signal during calibration, and allows the dipper to be used as a temporary signal generator for alignment work.

By **Bill Wildenhein, W8YFB**, 41230 Butternut Ridge, Elyria, Ohio 44035.

The dipper can also be used to check that your rig is tuned to the correct band. Switch off the B+ voltage to the dipper, but leave the heater voltage on. Poke the dipper into the rig near the output tank coil after you have tuned the rig, and tune the dipper for a peak instead of a dip. The peak will indicate which band you are actually on. Be careful of the high voltage!

plug-in coils

All the coils are wound on bases of defunct octal tubes. For those of you who have never smashed tubes, it can be done safely by holding the tube by the base with the glass envelope against the inside of a wastebasket. Give the glass a sharp rap with a hammer and the tube breaks without showering glass around as you would expect. Normally, the glass part cemented into the base remains relatively



This view shows the GDO with the top of the enclosure and the dial face removed. The capacitor shaft fits through the notch in the top.

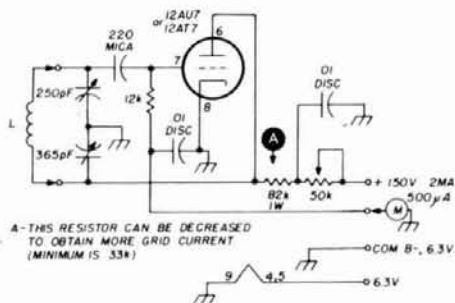

coil number	frequency range	wire size	number of turns
1	0.97 - 2.9 MHz	34 AWG (0.16 mm)	83
2	2.8 - 8.7 MHz	24 AWG (0.51 mm)	27
3	6.7 - 20 MHz	24 AWG (0.51 mm)	12
4	15 - 45 MHz	20 AWG (0.81 mm)	5
5	30 - 90 MHz	20 AWG (0.81 mm)	2

fig. 1. All the parts for this "no-cost" grid dipper were salvaged from old radios and TV sets. All coils are wound on 32 mm (1-1/4 inches) diameter octal tube bases; winding length is 14 mm (9/16 inch).

intact. This part of the glass can be broken up by punching it with a screwdriver. The remaining cement can easily be scratched out with a jackknife. Remove the leads from the pins by applying a soldering iron to the tips of the base pins while you pull on the leads with a pair of pliers.

Line up the tube bases after they are cleaned and select a pair of pins roughly opposite from each other (different tubes may have different base arrangements with some pins missing). Adjacent to one pin drill about a 1.5 mm (1/16 inch) hole as close to the bottom of the base as possible. Adjacent to the other pin, drill a 1.5 mm (1/16 inch) hole 14 mm (9/16 inch) higher up on the socket from the first

hole. Be sure the desired pins are cleaned of solder. It sometimes helps to run a piece of enameled wire down through the pin hole while heating the pin with a soldering iron. The wire sizes listed on the schematic need not be exactly as shown. Those are the wire sizes I used, but coils 2, 3 and 4 could use the wire commonly used in the yoke windings of TV sets. The first coil could use either number-34 or -36. This size range is often found in audio interstage transformers. If you are unwinding a transformer, it is easy to find out whether a particular wire size will fit. From the loose end of the transformer winding, measure 14 mm (9/16 inch) and place a bit of masking tape there as a marker. As you unwind to this point, count the turns. If there are at least 80 turns to that point, the wire is small enough for the job.

As a last resort, if you can't find wire that small, you can find a size that allows perhaps, 60 turns in the total length. Wind the 60 turns, then continue winding over the first layer to get a smooth layer of about 15 turns. Then wind up over that second layer with a third layer totaling, perhaps, 10 turns. If you have never hand wound coils, here are some of the basics: First, carefully scrape the enamel insulation from one end of the wire. Poke the end through the hole in the base nearest the pin end. Now poke the wire down through the proper pin and solder it into the pin. Carefully pull the excess wire back through

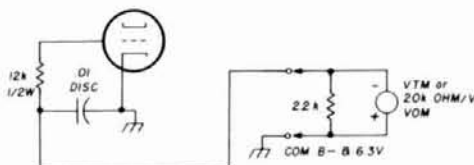
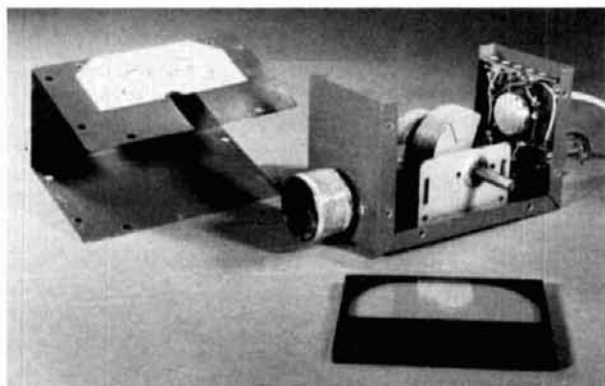

fig. 2. If you don't have a sensitive milliammeter, substitute a 2200-ohm resistor in its place and read the voltage drop across the resistor with a vtm as shown here.



The finished grid-dip oscillator with the coils for different tuning ranges.

the 1.5 mm (1/16 inch) hole. Avoid kinks as they seriously weaken the wire. If one of these kinks forms, straighten the wire as you pull it through the hole so the kink isn't pulled tight.

Now reel off a length of wire and fasten the spool in a vise. Pull the wire taut. Make sure there are no kinks, though. Holding the coil form with both hands, wind your way toward the vise, keeping tension on the wire. When the correct number of turns are on the form, hold the winding from slipping with one hand and cut off the wire to leave 15 to 20 cm (6 to 8 inches) of excess. With your free hand, scrape the enamel off enough of this end to get through the other pin. Poke this end of the wire through the top 1.5 mm (1/16 inch) hole, pull it up tight, and put your thumb over it to keep it from slipping. Poke the end down through the correct pin and pull it taut. Pull it over to the side to make a sharp bend at the end of the tube pin. This will prevent the wire from slipping back through while you solder it to the pin. Now you can trim up the pin ends with a file.

Coat the entire winding and winding surface of the coil form with plastic model cement for Styrene models. Put on a heavy coat. For perhaps 15 minutes you will have to alternately stand the coil on the plastic locator between pins, then tip it over and

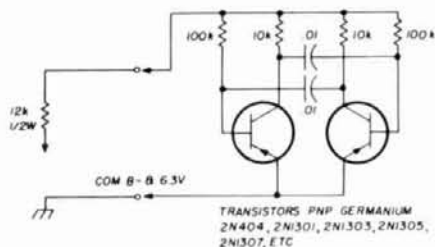

fig. 3. Simple modulator for the grid-dipper for fig. 1 uses a simple two-transistor oscillator which is powered by the grid current of the dipper.

stand it on the open end of the form as the cement slowly tries to run off the form. When it sets sufficiently that it stops running, leave it overnight. The next day add a second heavy coat. This will form a protective coating that will securely hold the turns in place when inserting or removing the coil, assuring that your calibration remains accurate.

Several of the coils are space-wound. After the winding of these coils is completed, the turns can be adjusted slightly until they are uniformly spaced.

enclosure construction

The photograph of the disassembled dipper shows the method of forming the sheet metal case. It was made of galvanized iron of the type used for furnace ducts. To form the sheetmetal box you need a couple lengths of angle iron about one foot long, and one piece about 5.7 cm (2-1/4 inch) long. Cold-rolled steel barstock is even better. Stock about 13x19 mm (1/2 by 3/4 inch) is good. In case you have neither, pick up some scraps of oak flooring and have a friend cut off the tongue and groove to give you a nice sharp corner. You also need a vise and a fairly husky C-clamp. Be sure to lay out and bend up the main

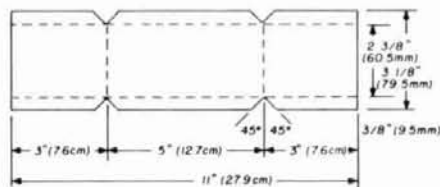

fig. 4. Sheet-metal layout used for the grid-dipper chassis.

chassis first. Fig. 4 shows the layout I used. If your tuning capacitor is larger, make your box slightly larger. Take pains to make the layout very accurate. It saves headaches later when you bend up the lid.

Fig. 5A shows a cross-section if the bends are made correctly. Notice that the overall width is 6 cm (2-3/8 inch) plus two metal thicknesses. The reason for this is quite obvious if you look at fig. 5B. If the bending bar is placed exactly on the line, the outside edge of the metal extends one metal thickness beyond the line. Now look at fig. 6A: the metal is clamped differently than in fig. 5B. If you make one bend as in fig. 5B and the other bend as in fig. 6A, you will end up with the lopsided, inaccurate cross section shown in fig. 6B. Compare the dimensions with those in fig. 5A; to get these dimensions, you must clamp the bending bars as shown in fig. 7.

This leads to a simple sheet-metal rule: if you want the *inside* dimension of a U-shaped bend held to a

size marked on a layout, the bending bars must also be on the inside, as shown in **fig. 7**.

For this first piece, the outside dimension is relatively unimportant. The lid is the really important piece because it must fit around this first box, and the inside measurement of the lid must be accurate. After this first piece is bent up, carefully measure the width at all points, then lay out and bend the lid. Next, lay out the holes in the lid and drill them with about a 5 mm (3/16 inch) drill. After removing the burrs, place the two sections together and carefully mark the hole locations on the inner box. These can be drilled with a number 36 (2.5 mm) drill. Then the box can be assembled with number 6 (about 3.5-mm diameter) sheet-metal screws salvaged from scrap TV sets.

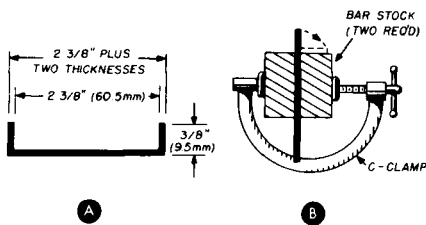
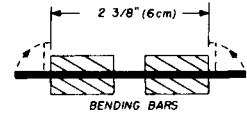

fig. 5. Proper method of bending the sheet metal used for the chassis (see text).

Locate and drill all socket holes, mounting holes and check the fit, then thoroughly clean both pieces with household cleanser. After they are dry they can be sprayed inside and out with gray primer paint before assembly and wiring is begun. The dial is made from a piece of card stock glued to the outer box. This is covered with a piece of clear plastic (small pieces are often available as scrap from hardware stores or glass shops). The "unbreakable" window panes are usually Plexiglass or Lexan, and they have very good rf insulating properties. For using a dial bezel, it is masked, then the layout drawn on the masking tape. With a sharp knife, cut away the part to be painted and spray with acrylic lacquer.

Your first homemade enclosure may take time and may be less than a professional job, but if you practice, using scraps of metal that can be picked up for free, you will soon find it possible to do a fast, accurate job the first time. I usually spend less than a half-hour to make this sort of enclosure. The result is that you are no longer limited to standard box sizes or costs. Your dollar savings will pay for any investment in tools many times over. For example, you can get a combination square at a discount store for as little as a dollar, but in most cases they are anything but square! The aluminum or pot metal

fig. 7. Proper setup for bending the flanges on a chassis to maintain an internal dimension (see text).



die-cast head may warp still more. For about \$5.00 you can get one with a steel or cast-iron head that will be acceptably accurate for sheet metal work. With just a little care it will last you the rest of your life, and will guarantee a lifetime of accurate boxes.

If you have a very limited budget and can't afford anything but that discount store square, here is a way to check the square in the store, and pick the one that is square (see **fig. 8**). Take along a piece of sheet metal that has one edge sheared true and straight. If the square isn't a true 90 degrees, it will show up immediately as shown in the drawing. Just place it on the metal as shown in position A and scribe a line on the metal. Swing it around to position B and see if it falls exactly on the previously scribed line. Watch out for a head with a crooked edge, as in **fig. 9**. Strive for an accuracy of about 0.5 mm in 25 mm (1/64 inch in 10 inches), or better. It will make your work far easier.

calibration

Finally, let's cover calibration of the grid dipper. Up to about 30 MHz it can be checked against a general-coverage receiver. Above that frequency you may have to find a friend with a calibrated vhf dipper. Begin calibration at the lowest frequency and work toward the high end because general-coverage receivers commonly use a 455-kHz i-f which leads to poor image response at the higher frequencies. Starting at the low end, your calibration points will be accurate. If you are in doubt about one point, you can return to the last point to be sure you are correct, then carefully proceed higher in frequency. Another check is to watch the receiver's S-meter. The image signal is usually noticeably lower on the S-meter.

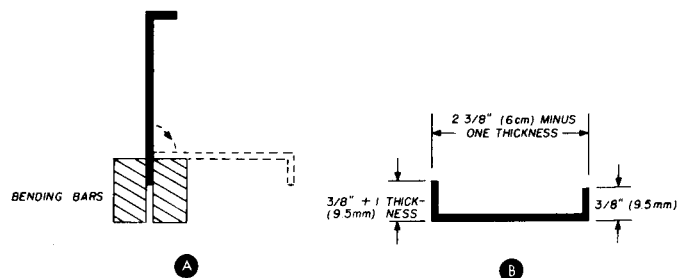

fig. 6. If bend bars are not used properly, one side of the chassis will have a different dimension than the other due to metal thickness (see text). Proper setup is shown in **fig. 7**.

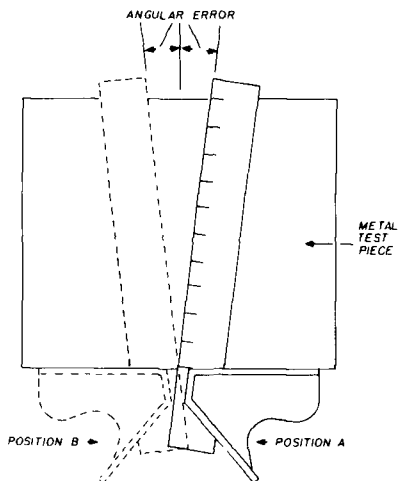

fig. 8. Simple method for checking the accuracy of a low-cost square.

Since the power output of this dipper will probably be as high as 200 milliwatts, it is inadvisable to attempt to use it to dip circuits connected to solid-state devices. You can easily blow a transistor. Remove the transistor before checking a circuit, but realize

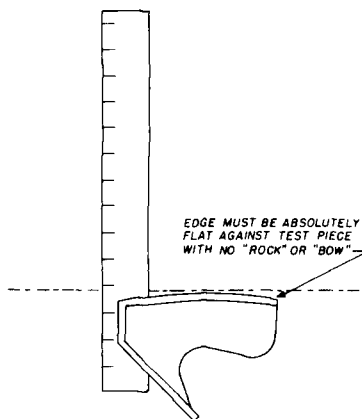

fig. 9. Beware of low-cost squares that are not perfectly flat — they should not rock against the test piece as shown here.

that the transistor itself adds capacitance to the circuit. I usually dip tank circuits before installing them, and include a small fixed capacitor to represent the capacitance of the transistor.

In conclusion, although this device is a homely looking gadget built from junk, it is still worth the effort to do the job right. I find it so stable and reliable that it has become one of the hardest working tools on my bench. I hope you enjoy the same benefits.

ham radio

MADISON SUPER SUMMER BUYS

NEW OMNI-J 2-meter mobile or portable antenna 3/8" thread, 5-dB gain (1.5-dB gain over conventional 5/8 wave mobile whip antenna). \$29.95; 220-MHz \$27.95. 450 MHz \$27.95. Guaranteed results.

FINCO Amateur beams in stock: A62 \$61.00

KLM: Antennas, Linears, Accessories All In Stock. FREE balun w/2 meter base antenna.

BIRD 43 Wattmeter plus slugs, in stock, prepaid freight.

BENCHER keyer paddles in stock \$39.95; chrome \$49.95

MIDLAND 23-136 dual meter, reads SWR and relative POWER handles 1 kW from 3-150 MHz \$21.95

NEW DRAKE TR-7 Call for Quote

TELE-TOWER: 40' w/breakover \$299

55' w/breakover \$399

MICROWAVE MODULES in stock

F9FT TONNA antennas: 144/16 el. \$55.95

9/19 OSCAR \$53.00

JANEL Preamps in stock

TECHNICAL BOOKS: ARRL, Sams, TAB, TI, Rider, Radio Pub.,

Callbook, Cowan, TEPABCO, many others call

HAM X ROTOR (New Model) Turns 28 sq. ft. of antenna. List

\$325. In stock. Your Price \$249

CDE HAM-III \$129.00

SWAN METERS: WM 6200 VHF Wattmeter \$49.95

SWR 3 Mobile \$9.95

TELEX HEADSETS in stock

CETRON 572B \$27.95 ea.

ADEL nibbling tool, \$6.45; punch \$3.50

CABLE 5/32", 6-strand, soft-drawn guy cable. For mast or light tower, 36 foot.

BELDEN COAX CABLE: 9888 double shield RG8 foam coax,

100% braid, suitable for direct bury 39¢ ft., 8237 RG8 21¢ ft.

8214 RG8 foam 25¢ ft., 8448 8-wire rotor cable 16¢ ft., 8210 72

ohm kw twinlead \$19/100 ft., 8235 300 ohm kw twinlead

\$12/100 ft., Amphenol PL-259, silverplated 59¢. UG175 adapter

19¢. PL-258 dbl female \$1.00. BNC female chassis mount 59¢

ea; MICRO RG-8/U same size as RG-59, 2 KW PEP @ 30 MHz

16¢ ft.

BELDEN 14 gauge cop. stranded antenna wire. \$5/100 ft.

TIMES 1/2" foam hardline 60¢/ft. connectors \$15 ea.

KESTER SOLDER 1 lb. 60/40, .062 \$6.50

LEADER — Amateur Test Equip. — 10% off list.

MALLORY 2.5A/1000 PIV epoxy diode 19¢ ea.

.001 MFD 20KV CAP. \$1.95

GE receiving tubes. 50% off list

GE6146B, 8950 \$7.95 ea.

SAY Electronic Power Supplies

Completely Regulated 13.8 to 20 volts dc, variable. Separate volt and amp meters. Dual protection against over voltage and over current.

4 amp \$59.95

8 amp \$109.95

20 amp \$159.95

CALL FOR QUOTES ON: YAESU FT-901DM, FT-625, FT-225, KENWOOD TS-820S, TS-520S, TR-7400A, ALDA, AMCOMM, VHF-ONE PLUS & ETO-ALPHA. ALL IN SEALED CARTONS. CALL FOR QUOTES ON ITEMS NOT LISTED. THIS MONTH'S SPECIAL: BEARCAT 210 SCANNER \$249. BEARCAT 250 WRITE OR CALL.

CALL FOR FAST QUOTES SPECIAL ORDERS WELCOME

TERMS: All prices FOB Houston. Prices subject to change without notice. All items Guaranteed. Some items subject to prior sale. Send letterhead for Amateur dealers price list. Texas residents add 5% tax. Please add postage estimate.

MADISON ELECTRONICS SUPPLY, INC.

1508 MCKINNEY
713/658-0268

HOUSTON, TEXAS 77002
Nites 713/497-5683



neat packaging for vhf prescalers

Novel packaging
for K4GOK's prescaler
uses readily
available parts

At least one thing is quite apparent from the popularity of technical literature in amateur radio circles. A large part of the hamming community is putting certain minimums of time into electronic gear construction. To a big segment of talented do-it-yourselfers in hamdom, this kind of involvement is necessary to get maximum enjoyment from the hobby. It's not easy. Even those who live for the smell of hot rosin and solder soon learn that workbench time is a scarce luxury. One result of the paucity of time is that we get only the highest priority stuff to the bench and quite simply, lean on the stories others tell (or write) to learn about out-of-reach or lower priority items.

It is pretty well known that not being in a position to build a super hot new receiver doesn't spoil the fun of reading about how the author did it. The buzz

word for this, of course, is *vicarious* and we'd be in rough shape without being able to enjoy things vicariously.

Even with the best intentions, many construction projects find their way into a file cabinet to await future action. Occasionally one may be pulled from the file and placed on the workbench for further thought, but every now and then lightning strikes and a construction article comes along to absolutely ruin your peace of mind until you can translate that writer's words into reality.

K4GOK's prescaler, as detailed in *ham radio* for February, 1976,* was just such a bolt for me. It turned out so well and so easy to assemble that I thought it deserved a little extra mention in all the shacks where it is filed under *projects — future*.

There is probably a great number of frequency counters in use which conk out at 50 MHz — or less. The need, however, for accurate frequency measurement in today's hamshack is in the order of 300 MHz, and if not a requirement for 2-meter fm, it is certainly a great convenience.

*M. D. Kitchens, K4GOK, "VHF Prescaler for Digital Frequency Counters," *ham radio*, February, 1976, page 32.

By Alan Smith, W8CHK, 3213 Barth Street,
Flint, Michigan 48504

Freedom of choice

There is no problem if you are in a position to select your needs from a supplier's shelf, but if you are in the more common position and want to soup up a flea market special or your old reliable Heath 1101, this prescaler is for you.

The construction approach recommended here is to build the prescaler as a separate unit. It will be easy on time and gentle on your pocketbook. You can even get several parts at your local Radio Shack store.

The unit in the photograph was built by my son, WB8YOB, and is a self-contained copy of the circuit described by K4GOK. As shown in the photo, it is set up to prescale two-meter signals with a rubber duck antenna as the coupling element.

The case is an Archer 270-250 (\$2.98 from Radio Shack). You can get the transistors at Radio Shack

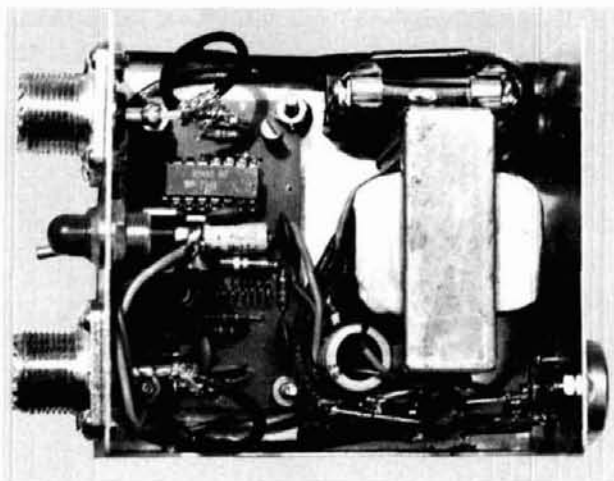

Construction of the vhf prescaler showing the layout of the perfboard with the preamplifier and 95H90 decade scaler, left, and power supply components, right. Input and output coaxial connectors, left, give a good idea of the small size of the package.

by substituting 2N706 for 2N5179 and MPS-6533 for 2N5771. Otherwise the circuit can be assembled exactly as described in the original article.

The power supply is conventional. It requires a circuit-board transformer with an output voltage of 5.5 volts or more up to a maximum of 12 volts at 300 mA, a standard 500 mA bridge rectifier, one 1000 μ F electrolytic capacitor, and an LM309K IC voltage regulator. The LM309K will keep the supply voltage at the required 5 volts.

These parts can be neatly fastened to a square of perf board and secured to the case, or the transformer can be fastened to the base and the remaining components simply hard wired. Add an on-off switch and a miniature red indicator light and you'll be ready to start prescaling.

ham radio

In the past when your YAESU or KENWOOD dealer said the CW crystal filter for your set was **optional** you had a choice: Buy one of his **standard** units — or do without.

NO LONGER!

Now FOX-TANGO not only offers filters similar in bandwidth to those supplied by your set's manufacturer, but also **sharp** eight-pole, 250 Hz bandwidth filters with superior shape factors at an unbeatable price — some similar units are being advertised for \$100! **And even so, they are not as sharp.**

BUT THAT'S NOT ALL

Yaesu's CW filters for the FT-101, FR-101 and FT-301 Series have a bandwidth of 600 Hz. Most hams feel 600 Hz is too wide for today's conditions but that's not the only reason they find the going rough when the band is crowded: Yaesu's filters are only six-pole. Ours are eight-pole — with a superior shape factor and **500 Hz** bandwidth. Wide enough for tuning ease, yet sharp and selective enough to cut through all but the heaviest DRM. *And for the Kenwood CW enthusiast* FOX-TANGO now offers, in addition to the sharp eight-pole 250 Hz units for the TS-520, R-599, and the TS-820 Series; **new** eight-pole **400 Hz** filters with characteristics superior to those of the regular Kenwood 500 Hz units.

SOME REAL OPTIONS

But talk about FREEDOM OF CHOICE! Inexpensive, easily installed diode-switching boards are now available for all the above sets which permit the *addition of up to two crystal filters in addition to those for which the manufacturer provides space.* For example, if you have no CW filter at present or are just buying your set (which never comes with the filter factory-installed) you can select either of our superior units, secure in the knowledge that you can add the other later if you wish. Or if your rig already has a standard CW filter installed, you can add our sharp unit so that either can be switch-selected often using existing front panel controls. Just imagine! Nail your rare DX with the standard-type filter and cut out the crud and crowd with the flip of a switch. Now that's OPERATING!

HOW WE DO IT

Some hams have wondered how we can offer superior filters at such a low price. And they are superior, not only on the basis of laboratory tests but according to members of the International Fox-Tango Club who have used them in their rigs for many months. The answer to the "low price" question is that these filters are made for us in Japan by a concern with almost a quarter-century of experience in the design and production of these units, among others, for use in the best-known and most respected brands of both amateur and commercial gear. In the past their filters were sold exclusively to set manufacturers. Now they are being offered at retail for the first time — and at **introductory prices** — through our organization only.

GET YOURS NOW AND BEAT THE INFLATIONARY SPIRAL!

Our Filters are sold on a Money-back Guarantee Basis.

FOX-TANGO CORP.

Box 15944, W. Palm Beach, FL 33406

DIODE SWITCHING BOARDS

permit easy mounting (without drilling) of up to two crystal filters of any type in addition to those for which the manufacturer provides space. These boards will accommodate any of the filters listed below and other types planned for the future. They include one stage of amplification to compensate for filter insertion losses, if desired. Complete instructions. **SPECIFY Set with which board is to be used. \$15 with purchase of any filter. \$20 without filter. Airmail Ppd. US & Canada. Overseas add \$1.**

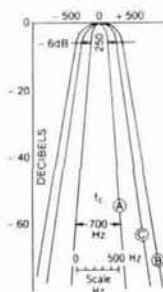

BANDWIDTH 50B DOWN		TYPE NUMBERS FOR ORDERING	
Hz	TYPE	CW FILTERS FOR YAESU	
250 (A)	YF31H250	FT101	FT301
500 (B)	YF31H500	YF8H250	YF8H500
		CW FILTERS FOR KENWOOD	
250 (A)	TS-520R599	TS-820	
400 (C)	YF33H400	YF8H250	YF8H400

ALL TYPES

Only **\$50**
Airmail Ppd. US
& Canada. Overseas
add \$3
Circle type
desired.

I enclose \$ _____ Check Money Order Cash
(Make checks payable to FTC)

I prefer to charge my

VISA Master Charge

Name _____

Account No. _____

Address _____

Expiration date: _____

City _____

MC 4 digit no. _____

State _____ Zip _____

Florida residents add 4% Sales Tax.

precision voltmeter calibrator

It's always nice to have a high-accuracy, digital voltmeter around, but unfortunately they're very expensive. To solve this problem, I decided to build a variable voltage source to accurately calibrate the dc voltmeters I had on hand. There have been many precision ten-volt sources described in current literature;^{1, 2, 3} I have used the circuit shown in reference 1 as the basis for my design.

circuit details

The circuit shown in **fig. 1** will produce from 0 to 10 volts with an error of less than 20 millivolts. In addition, it's also accurate with meter movements that have an internal resistance as low as a few thousand ohms. The 10 volts developed by the LM308 appears across R4. In my case, I used a ten-turn potentiometer-

ter and a suitably accurate ten-turn dial. The output from this potentiometer is fed into a 741 op amp connected for unity gain. In this way the op amp's high-input impedance will have negligible loading on the voltage source and its low output impedance will allow the calibration of meters with low internal resistance.

It will be necessary to null out the small dc offset error which appears at the output of the 741 op amp. This is accomplished by the 10k potentiometer, R5; ground the input of the 741 and adjust R5 for zero volt output. The nulling procedure must be completed before final calibration is attempted. **Table 1** shows the results of calibration against a known voltage source.

For operation, this calibrator requires plus and

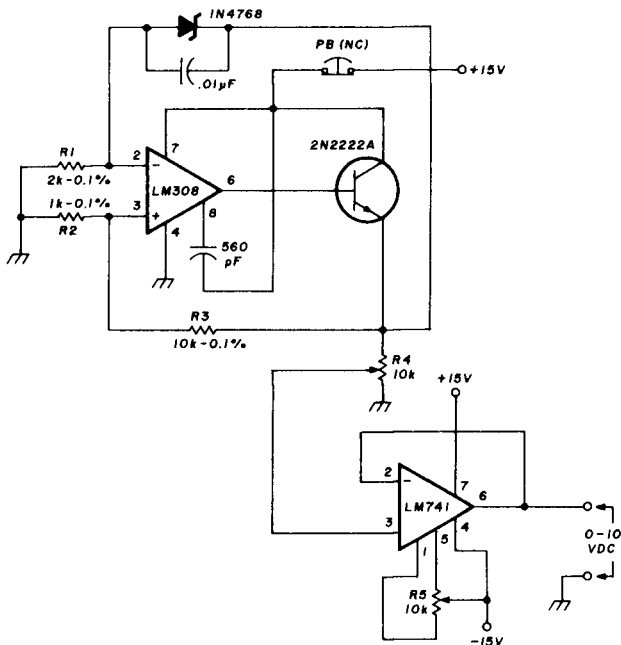

fig. 1. Schematic diagram of the 0 to 10 volt voltage standard. The pin numbers for the op amps are for the 8-pin mini-DIP package. R4 is a 10-turn potentiometer with a linearity of 0.1 per cent. The resistor tolerances should be closely observed to obtain a precise 10-volt output from the LM308.

table 1. Calibration results for the 0 to 10 volt standard.

nominal voltage as read on R4	laboratory potentiometer reading
10.00	10.00
9.00	9.00
8.00	7.99
7.00	7.00
6.00	6.00
5.00	5.01
4.00	4.00
3.00	3.00
2.00	2.00
1.00	1.00
0.00	0.00

minus 15 volts, at less than 50 mA. The normally closed switch shown in **fig. 1** is used to start the calibrator by creating a transient through the 560 pF capacitor. If the power supply for the calibrator is already running, this switch can be eliminated. Finally, you should realize that this calibrator can not be used as a substitute for a variable voltage power supply.

references

1. William Goldfarb, Electronics Circuit Designers Casebook, *Electronics*, June 7, 1975, page 107.
2. David W. Ishmael, WA6VVL, "Precision 10.000 V dc Reference Voltage Standard," *73*, September, 1975, page 124.
3. *Linear Data Book*, National Semiconductor Corporation, Santa Clara, California 95051, page 2-1.

By Hubert Woods, Calle Las Nubes, 1760, Guadalajara 5, Jalisco, Mexico

ham radio

600 MHZ. FREQUENCY COUNTER ±0.1 PPM TCXO

OPTO-8000.1

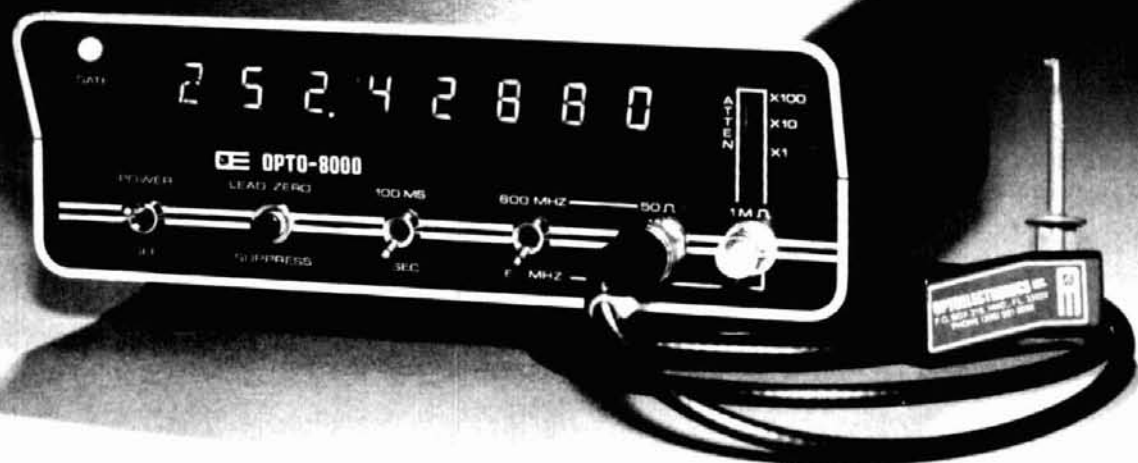

This new instrument has taken a giant step in front of the multitude of counters now available. The Opto-8000.1 boasts a combination of features and specifications not found in units costing several times its price. Accuracy of ± 0.1 PPM or better — *Guaranteed* — with a factory-adjusted, sealed TCXO (Temperature Compensated Xtal Oscillator). **Even kits require no adjustment for guaranteed accuracy!** Built-in, selectable-step attenuator, rugged and attractive, black anodized aluminum case (.090" thick aluminum) with tilt bail. 50 Ohm and 1 Megohm inputs, both with amplifier circuits for super sensitivity and both diode/overload protected. Front panel includes "Lead Zero Blanking Control" and a gate period indicator LED. AC and DC power cords with plugs included.



OPTOELECTRONICS, INC.

5821 NE 14 Avenue
Ft. Lauderdale, FL 33334
Phones: (305) 771-2050 771-2051
Phone orders accepted 6 days, until 7 p.m.



SPECIFICATIONS:

Time Base—TCXO ± 0.1 PPM GUARANTEED!
Frequency Range—10 Hz to 600 MHz
Resolution—1 Hz to 60 MHz; 10 Hz to 600 MHz
Decimal Point—Automatic
All IC's socketed (kits and factory-wired)
Display—8 digit LED
Gate Times—1 second and 1/10 second
Selectable Input Attenuation—X1, X10, X100
Input Connectors Type —BNC
Approximate Size—3" h x 7 1/2" w x 6 1/2" d
Approximate Weight—2 1/2 pounds
Cabinet—black anodized aluminum (.090" thickness)
Input Power—9-15 VDC, 115 VAC 50/60 Hz
or internal batteries
OPTO-8000.1 Factory Wired **\$299.95**
OPTO-8000.1K Kit **\$249.95**

ACCESSORIES:

Battery-Pack Option—Internal Ni-Cad Batteries and charging unit **\$19.95**
Probes: P-100—DC Probe, may also be used with scope **\$13.95**
P-101—LO-Pass Probe, very useful at audio frequencies **\$16.95**
P-102—High Impedance Probe, ideal general purpose usage **\$16.95**
VHF RF Pick-Up Antenna-Rubber Duck w/BNC #Duck-4H **\$12.50**
Right Angle BNC adapter #RA-BNC **\$ 2.95**

FC-50 — Opto-8000 Conversion Kits:

Owners of FC-50 counters with #PSL-650 Prescaler can use this kit to convert their units to the Opto-8000 style case, including most of the features.

FC-50 — Opto-8000	Kit \$59.95
*FC-50 — Opto-8000F	Factory Update \$99.95
FC-50 — Opto-8000.1 (w/TCXO)	Kit \$109.95
*FC-50 — Opto-8000.1F	Factory Update \$149.95

*Units returned for factory update must be completely assembled and operational

TERMS: Orders to U.S. and Canada, add 5% to maximum of \$10.00 per order for shipping, handling and insurance. To all other countries, add 10% of total order. Florida residents add 4% state tax. C.O.D. fee: \$1.00. Personal checks must clear before merchandise is shipped.

the gyrator: a synthetic inductor

Using operational amplifiers
you can
simulate inductors
in LC filter design

The Gyrator is an electronic device that inverts the impedance of a capacitor and therefore makes it take on the characteristics of an inductor. Through the use of such a device, some of the shortcomings of inductors can be eliminated. These shortcomings are large physical size, low Q , nonlinearity, and interwinding capacitance.

A properly designed Gyrator will provide a synthetic inductor with high Q , wide bandwidth, inductance value independent of frequency, and good stability. Filters for frequencies up to 50 kHz can be designed using Gyrators.

LC filters

Since a Gyrator can be inserted directly into an LC filter in place of an inductor, let's first review how an LC filter works. An LC filter is a reactive, two-port,

doubly-terminated device that reflects power back to the source in frequencies that fall outside its band-pass. As the number of individual elements making up the filter is increased, the ability of any one component to greatly change the resonant frequency decreases. It can be said, therefore, that a coupled

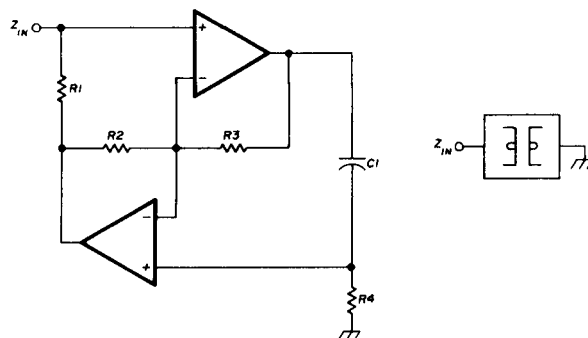

fig. 1. Basic Gyrator circuit and standard Gyrator symbol. Circuit is the basis for designing filters without inductors.

LC filter is basically rather insensitive to changes in values of either capacitors or inductors. What will happen (when changing a component) is that the amount of power reflected to the source will be decreased. As other component values are changed, the reflected power becomes less and less, and the stop bands become more and more poorly defined.

By John Loughmiller, WB9ATW, Route 1,
Box 480C, Borden, Indiana 47106

designing a Gyrator filter

To implement an LC filter without an inductor, first calculate the required inductive and capacitive impedance for the filter you have in mind. If desired, the filter can be built using standard inductances to check your calculations before actually building the Gyrator.

Next, using the circuit in **fig. 1**, construct a Gyrator replacement for the inductor. This circuit will simulate an inductor with the value of KC , where K is a constant derived from the resistors: $K = (R1 \cdot R3 \cdot R4) / R2$, and C is the capacitor whose impedance is being inverted ($C1$ in the circuit).

The resultant number so derived can be treated as if it were the value of impedance of an inductor, and the actual inductor can be removed and replaced with the synthesized inductor just created.

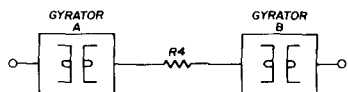

fig. 2. Method for simulating an ungrounded inductor using two Gyrators. Resistor $R4$ is the resistor that determines the simulated inductance.

A simpler approach is to make all four resistors the same value and use the formula R^2C . (The impedance presented to the input of the Gyrator is very nearly $j\omega R^2C$, hence the formula R^2C). Use a value of R large enough that the op amps won't be loaded, yet slightly lower than the differential input impedance.

The Gyrator circuit appears to be just another active filter circuit; however, there's a significant difference: in other active filter circuits amplifier phase shift degrades circuit Q . In Gyrators, the Q is enhanced. When the phase shift is greater than 90

table 1. Typical Q of various types of capacitors at 1 kHz.

capacitor type	Q at 1 kHz
Mica	600
NPO ceramic	1500
Glass	1500
Polystyrene	2000
Polypropylene	3000

degrees, the Q is actually *higher* than that of the capacitor itself.

Speaking of capacitors, **table 1** indicates the Q to be expected (at 1 kHz reference) for various types of capacitors. You can see that a high- Q inductor can be synthesized by using one of the high- Q capacitors, since the Gyrator inverts its capacitive impedance into an inductive-type impedance.

With regard to temperature, the NPO ceramic is least affected by changes of this variable. Higher stability could therefore be expected if NPO-type capacitors were used; however, there would be a tradeoff in Q . For high Q the choice is polystyrene or polypropylene, with the latter perhaps a better choice as it has a better temperature coefficient.

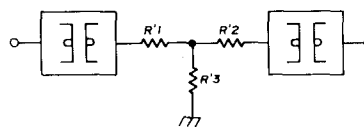

fig. 3. Synthesized T filter using Gyrators, which performs as if it were constructed as a standard T filter using inductors.

pylene, with the latter perhaps a better choice as it has a better temperature coefficient.

floating inductors

Perhaps the principal drawback to Gyrators is the fact that a floating (ungrounded) inductor can't be simulated by a single Gyrator. It's possible, however, to use two Gyrators as in **fig. 2** and successfully simulate such an inductor.

The formula is $L = [(R1 \cdot R3 \cdot C) / R2] R4$, and $R4$ is a shared resistor between Gyrator A and B, as in **fig. 2**. $R4$ is the resistor that determines the simulated inductance. So if $R4$ becomes a loaded port, the simu-

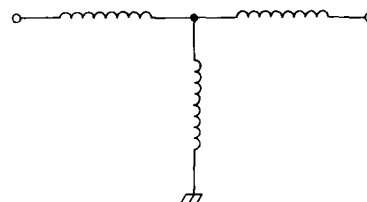

fig. 4. T filter using inductors in the usual manner, which can be simulated by Gyrator techniques.

lated inductance will be dependent on the value of resistance connected to the port. This being the case, resistor $R4$ could (if desired) be divided into sections and T or pi filters simulated, such as shown in **fig. 3**. Here, a T filter is created synthetically, which would perform as if it were constructed in the manner shown in **fig. 4**.

When building multisection filters, a quad op-amp is recommended. A 4136 is the choice of Mr. Thomas Lynch, from whom much of the information in this article was obtained.

bibliography

1. Thomas H. Lynch, "The Right Gyrator Trims the Fat Off Active Filters," *Electronics*, July 21, 1977, page 115.
2. William C. Sutherland, "Op-Amp Gyrator Simulates High-Q Inductor," National Aeronautics and Space Administration Tech Briefs, Vol. 2, No. 3, Fall, 1977, page 318.

ham radio

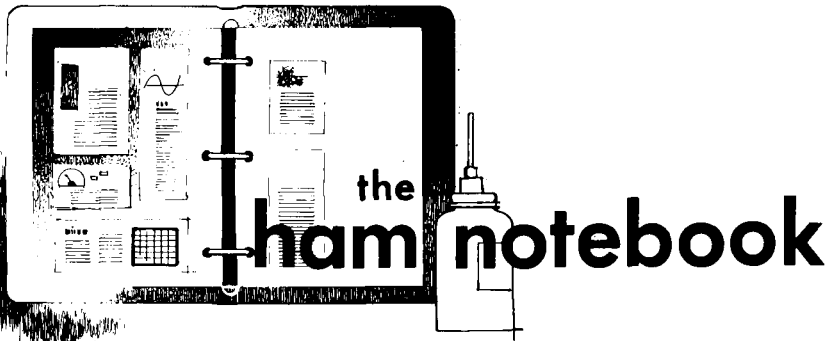

pi-network rf choke

The great majority of pi-network rf amplifiers use shunt feed for the high voltage dc to the plate. Therefore, great dependence is placed on the isolation properties of the rf choke. Most chokes are not suitable for this purpose due to resonances, especially when the amplifier is a multiband unit.

The most successful shunt feed rf chokes are single layer solenoid wound, preferably using resistance wire to lower the Q and damp out potential resonant frequencies. One of the best chokes was the one made by Collins for the ART-13 transmitter.

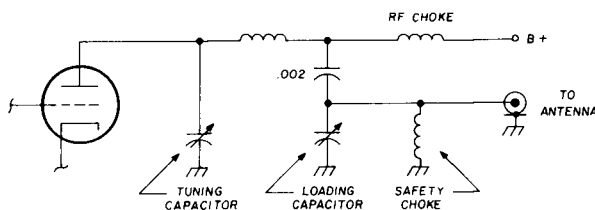

fig. 1. Suggested placement for rf choke in multiband rf power amplifiers. Since this is a low-impedance point in the output circuit, it reduces the performance requirements of the rf choke.

They are difficult to obtain, however. To avoid the problem, series feed at a low rf potential point as shown in fig. 1 is suggested. In this circuit any of garden variety rf chokes are suitable. The plate blocking capacitor is now at the low rf potential part of the circuit; it must, however, be able to withstand the high voltage dc and be able to carry the tank circuit rf current without overheating. Transmitting

ceramic capacitors are recommended.

Gary Legel, W6KNE

calculating feedline loss with a single measurement at the transmitter

Much has been written about the amount of insertion loss of various types of feedline and connectors, and about how the loss in some types of coax increases sharply with age and exposure to the elements. What is not widely known in amateur circles is that the loss in any run of cable can be determined with only an swr bridge or wattmeter, a transmitter or

To determine the cable loss, disconnect the antenna from the feedline and replace it with a shorted connector. This produces the infinite vswr at the transmitter end of the cable more reliably than simply leaving the cable unterminated. Connect the swr bridge or wattmeter at the transmitter end and measure the vswr of both forward and reflected power, using the lowest possible transmitter power to avoid possible damage to the final amplifier. The reflection coefficient, ρ , is found by using one of the following formulas:

$$\rho = \sqrt{\frac{P_{\text{reflected}}}{P_{\text{forward}}}} \text{ or } \rho = \frac{SWR - 1}{SWR + 1}$$

This reflection coefficient is a numerical ratio which must then be converted to decibels:

$$\rho(\text{dB}) = 20 \log_{10} \left| \frac{1}{\rho} \right|$$

Note that a vswr of ∞ corresponds to $\rho = 1$ or $\rho(\text{dB}) = 0 \text{ dB}$, and a vswr of 1.0 corresponds to $\rho = 0$ or $\rho(\text{dB}) = \infty \text{ dB}$. The cable loss is determined by using the general equation:

$$\rho(\text{dB})_G = \rho(\text{dB})_L + 2A_o$$

where $\rho(\text{dB})_G$ is the reflection coefficient at the transmitter, $\rho(\text{dB})_L$ is the reflection coefficient at the load, and A_o is the cable loss in decibels. Since $\rho(\text{dB})_L = 0$ in this case,

$$A_o = \frac{\rho(\text{dB})_G}{2}$$

This same general formula can also be applied if vswr or wattmeter readings are taken at both ends of the cable with the antenna connected instead of the shorted termination. The

other drive source, and a shorted connector.

If a piece of cable is terminated with a short or an open circuit, the vswr measured at the transmitter will be infinite if the cable has zero insertion loss. In the real world, any cable has some loss, and this loss will cause the vswr measured at the transmitter to be less than infinity. The greater the cable loss, the lower the vswr.

advantage of using the shorted termination is that it eliminates the need to take readings at the antenna, which is usually a two-man job.

Once the feedline loss is known, the antenna is reconnected, and it is now possible to accurately determine the vswr at the antenna based on the reading taken at the transmitter:

$$\rho(dB)_L = \rho(dB)_G - 2A_o$$

$$\rho_L = \frac{1}{\text{antilog}_{10} \frac{\rho(dB)_L}{20}}$$

$$SWR = \frac{1 + \rho}{1 - \rho}$$

For most accurate results with multiband antennas, a feedline loss calculation should be made for each band.

John E. Becker, K9MM

RM terminal modification

After using the Mini Micro Mart RM Terminal Unit for a number of months, some deficiencies were noted which made it a little unwieldy to use, and sometimes downright difficult! I decided to pull all the guts out of it, because I didn't know how it worked, and if it broke, about all I could do is use it for weight in the back of my car in the winter. This modification is used to convert the parallel output of the original keyboard into special data for insertion into the loop of a RTTY system. In addition to this, it gives you end of line (EOL), letters, and figures indications through the use of an LED. The EOL feature is especially nice if you are using a video display which has less than the 66 characters necessary for a complete line of hard copy. In addition to this, it provides parallel data out, still in Baudot code, just in case you need it to feed an ASCII converter.

Looking at the schematic of the converter itself, the data from the RM terminal is fed into the UART and strobed into it through a 74121. The strobe from the keyboard is only a high, and it is necessary to have a

pulse, so I used the 74121 to make it. The UART is clocked with a NE555, which can be set at any speed. The required frequency for various speeds is:

speed	baud	clock frequency
60	45.45	728 Hz
66	50.00	800 Hz
75	57.00	912 Hz
100	73.70	1179 Hz

It can be seen that the clock speed necessary for the UART is the Baud rate times 16.

Coming out of the UART is the serial data, which is fed into a transistor driver, which keys an optical isolator. These devices are good for more than 20 mA, so if used in an application

shown is used for indication of which shift you are in.

This modification can be made quite easily, and the additional circuitry can be put on perf board or a separate printed-circuit board. I built the unit on a wire-wrap card because it was incorporated into another system.

Tim Ahrens, WA5VQK

switching inductive loads with solid-state devices

Recently, while attempting to interface my 8080A microprocessor to a model 26 Teletype machine, I destroyed the 8080A and a 2N2222

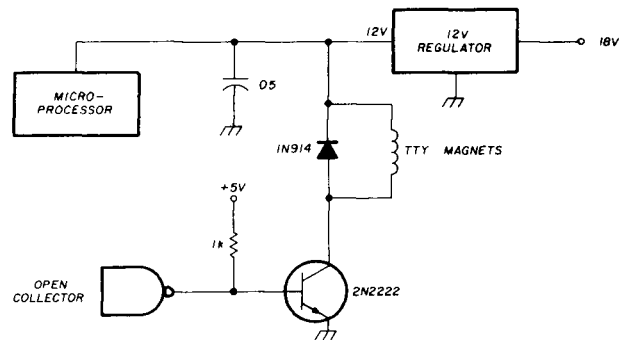

fig. 1. Initial circuit used by WA6ROC to interface an 8080A microprocessor with a teletypewriter. This arrangement destroyed both the expensive 8080A and the 2N2222.

where the loop is less than this, no problems should be noted. Please note the polarity.

Also coming out of the UART from pin 24 is a terminal which says in effect, "one character is finished;" this is normally high, and when the character is complete, it goes low for a moment. This pulse is fed into a CD4020 binary counter, which can be set up for any count up to 2^{14} . In this instance we are counting up to 64, which is close to the 66 count maximum. Fortunately, the CD4020 is also equipped with a reset, and when the carriage return key on the keyboard is struck, a positive pulse resets the chip, and the process starts all over again. The output from the 4020 is used to drive a flip-flop made from a 7400, but in the configuration shown, another section is used to drive a LED or audible alarm to show that the end of line has arrived. The other flip-flop

transistor. The following suggestions may help others from encountering problems when trying to switch inductive loads with solid-state devices. My first attempt at a switching circuit is shown in fig. 1. What happens is this:

1. Assume that the 2N2222 is conducting, the collector of the transistor is at 0.2 volt (it is saturated).

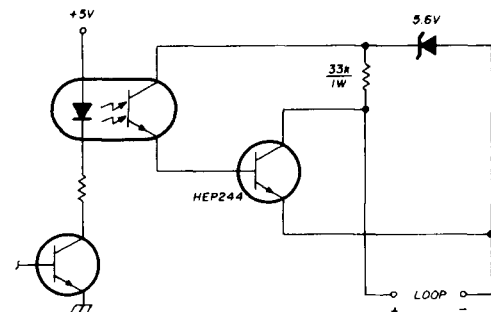

fig. 2. Basic opto-isolator circuit used by WA6ROC to provide protection to the delicate microprocessor.

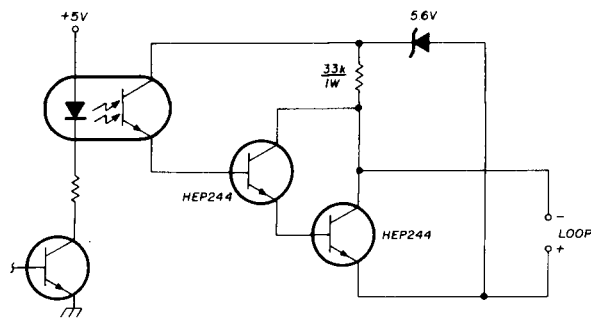

fig. 3. Since circuit of fig. 2 would not key low voltages, a Darlington pair was used, as shown here. Design of the circuit is discussed in the text.

2. The gate tries to turn off the 2N2222.

3. The inductor tries to maintain its current of 60 mA, thus the collector voltage of the 2N2222 rises, as it turns off.

4. When the collector reaches 12.7 volts the 1N914 starts to conduct. The +12 volt regulator, however, will not clamp its output at +12 volts (indeed most series-regulated power supplies will allow the output voltage to climb if you try to force current into the output).

5. Thus, the collector voltage of the 2N2222 climbs very high, and it experiences secondary voltage breakdown (fatal). Also, the +12 volt line follows the collector voltage (but it is one diode drop less). Thus the large spike on the +12 volt line destroys the microprocessor (and maybe other devices).

It was at this point that I decided to use an opto insulator — to provide a means of protection of the delicate microprocessor (or other solid-state parts). I tried the circuit which appeared in the November, 1976, issue of *ham radio** (see fig. 2).

This circuit is optically isolated, but it has one problem: it will not key low voltages. Since all I had at the time was a low-voltage power supply, a simple modification was made to allow this circuit to key a considerable amount of current, over a wide range of voltages.

The reason that this circuit will not key low voltage loops is that an

*K. Ebnetter, K9GSC, and J. Romelfanger, K9PKQ, "RTTY Test Message Generator," *ham radio*, November, 1976, page 30.

appreciable voltage will exist from the collector to the emitter of the HEP244 when it is turned on. Suppose the HEP244 is supposed to key a 60 mA loop, let us further suppose it has a current gain of 60. Therefore, to key the loop, the collector current will be 60 mA and the base current must be

$$\frac{I_c}{B} = \frac{60}{60} = 1 \text{ mA}$$

(actually $I_c = 59 \text{ mA}$, $I_B = 1 \text{ mA}$, $\beta = 59$)

To sustain conduction, the collector to emitter voltage must be

fig. 4. Final circuit configuration used by WA6ROC to interface a teleprinter with an 8080A microprocessor. The RC filter across the Darlington pair speeds up the release time of the print magnets.

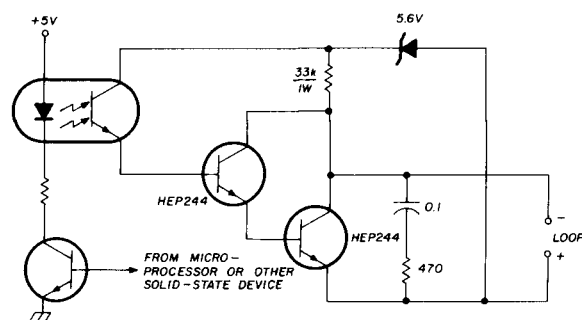

$V_{be}(\text{HEP244}) + V_{CESAT}$ (opto-isolator transistor) + $1 \text{ mA} \times 33 \text{ kilohms} = 0.7 + 0.2 + 33 = 33.9 \text{ volts}$.

The obvious way to reduce the collector-to-emitter voltage is to reduce the voltage drop across the 33k resistor. If the current gain of the HEP244 were higher, then it would draw less base current, and the voltage across the 33k resistor would be less. The best way to do this is to add another HEP244 and make the two transistors into a Darlington configuration as shown in fig. 2.

The effective current gain of the Darlington pair is β^2 so the current through the 33k resistor is about

$$\frac{60 \text{ mA}}{60 \times 60} = 167 \mu\text{A}$$

The collector-to-emitter voltage of the keying transistor(s) is

$$V_{BE2} + V_{CESAT} + 167 \mu\text{A} \times 33\text{k} = 0.7 + 0.7 + 0.3 + 0.55 = 2.25 \text{ volts}$$

(versus 33.0 volts before). This circuit will satisfactorily key both low and high voltage loops, and will handle quite a bit more current than 60 milliamps.

Now, as to the matter of protecting the keying transistor from secondary voltage breakdown. The common trick is to clamp the collector of the keying transistor to the magnet supply. If you do this, be sure to follow these two precautions:

1. Use a diode capable of carrying several amps, as the current through the suppressing diode can be several orders of magnitude greater than the magnet current, and small signal diodes (such as the 1N914) will often be destroyed by the large surge.

2. Make sure the magnet supply has sufficient capacitance to adequately absorb the energy of the spike without allowing the voltage to climb.

Sometimes, however, the clamping diode will slow down the release time of the magnets (because the diode allows the current flow to continue for some time). In a case where this is important, an RC filter across the keying transistor will usually solve the problem. Thus the final configuration (fig. 4) is the circuit I now use to key my teleprinter magnets.

Thomas C. McDermott,
WA6ROC

FREQ OUT. FOR LESS.



100 Hz to 50 MHz.
\$89.95*

Introducing CSC's new Mini-Max. It brings down the cost of counting up the frequency for CB-ers, hams, computer enthusiasts, audiophiles... just about any engineer, technician or hobbyist will find it indispensable. It's "mini"-sized, too — a pocketable 3 x 6 x 1½ inches.

But when it comes to performance, Mini-Max means maximum value. Measuring signals as low as 30 mV from 100 Hz to a *guaranteed* 50 MHz, with ± 3 ppm timebase accuracy and better than 0.2 ppm/°C stability from 0 to 50°C. *Completely automatically.* Advanced LSI circuitry with a crystal controlled timebase provides precise frequency readings on a bright, six-digit LED display, with automatic KHz/MHz indications. Mini-Max is versatile, too. You can connect it directly to the circuit under

test, or use its matching mini antenna for easy RF checking. Either way, the input is protected against overload to 50V (100V below 1 KHz).

Mini-Max is as inexpensive to use as it is to own. An ordinary 9 volt alkaline battery gives up to 8 hours of intermittent operation, and you have the flexibility of a battery eliminator for AC operation. For increased versatility, there's a complete line of accessories, including standard clip-lead cable and mini antenna — eliminator and carrying case are optional.

CSC's new, all-American made Mini-Max is everything you need for highly-accurate checking of frequencies up to 50 MHz. At a price that will Freq you out. Order today Call 203-624-3103, 9a.m. – 5p.m. Eastern Standard Time. Major credit cards accepted. Or see your CSC dealer. Prices slightly higher outside U.S.A.

CONTINENTAL SPECIALTIES CORPORATION



*Manufacturer's suggested retail price.
© 1978 Continental Specialties Corporation

70 Fulton Terrace, Box 1942, New Haven, CT, 06509, 203-624-3103 TWX 710-465-1227
WEST COAST 351 California St., San Francisco, CA 94104, 415-421-8872 TWX 910-372-7992
GREAT BRITAIN. CSC UK LTD., Spur Road, North Feltham Trading Estate, Feltham, Middlesex, England, 01-890-0782 Int'l Telex 851-881-3669
CANADA. Len Finkler Ltd., Ontario

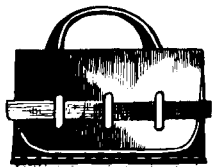

comments

satellite tracking

Dear HR:

The article in your September issue, "Tracking Oscar Satellites," was especially interesting, and I might make some comments regarding the nautical mile. Most Maritime nations, including the United States, have adopted the International Nautical Mile, which is exactly 1852 meters, or 6076.10333 . . . U.S. feet.

For most navigational purposes, the nautical mile is one minute of latitude or any other great circle. On the Clarke spheroid of 1866, used for mapping North America, the nautical mile varies from 6046 feet at the equator to 6108 feet at the poles. The length of one minute of a great circle of a sphere having an area equal to that of the earth is 6080.2 U.S. feet. This was the U.S. standard nautical mile prior to the adoption of the International Mile of 1852 meters.

One of the first attempts to establish a standard of length was made by the Greeks, who used the length of their Olympic stadium as a unit and called it, naturally, the stadium. It was 600 Greek feet (607.9 U.S. feet), or almost exactly one-tenth of the International Nautical mile. The Romans got into the act with a 625-foot stadium (606.3 U.S. feet). This is quite close to the British Cable of 608 feet. The Roman Mediterranean mile of 4859.59 feet was gradually replaced by the Greek unit and was probably the mile referred to in the

Bible (Matthew 5:41). The word mile comes from the Latin *mille* (thousand) — the one-thousand paces of the Roman mile.

For convenience in short-range plotting in the Navy and Maritime Service, the Radar Plotting Sheet and Maneuvering Board use a 6000-foot (2000-yard) mile, which differs from the Nautical Mile by slightly over 1 per cent. It greatly simplifies range instruments, gear ratios, and computations, and is within the range accuracy of most electronic navigation systems.

I have written several navigational programs for my HP-97 calculator, and, in great-circle distances and bearing calculations, I use the 1852-meter International Nautical Mile.

I. L. McNally, K6WX
Sun City, California

active filters

Dear HR:

I would like to compliment W4IYB on the fine article concerning active RC filters in the October 1976, *ham radio*. He has presented three basic filter configurations, each with dif-

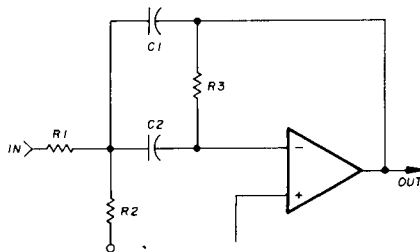

ferent adaptations. Personally I prefer the second configuration; I have used it in thousands of modems sold to users of the telephone network. I ran off a computer tracing of the band-pass characteristics of the filters, both single and 4-unit combinations, based on a Q of 6. My curves come

quite close to what is shown in W4IYB's fig. 2. I should mention however, that the equations you presented are difficult for the average ham radio reader. I use the following simpler equations:

$$R_1 = \frac{Q}{C \cdot f \cdot g \cdot 2\pi}$$

$$R_2 = \frac{1}{2 \cdot (Q - 9/Q) \cdot C \cdot f \cdot 2\pi}$$

$$R_3 = \frac{2 \cdot Q}{C \cdot 2\pi \cdot f}$$

where

$$C = C_1 = C_2$$

g = gain from input to output (usually set to 1 or 0.5)

Q = not more than 10 or 20 for 741s in the audio range

f = frequency in the audio range

Robert H. Weitbrecht, W6NRM
Redwood City, California

noise interference

Dear HR:

I ran across an unexpected source of interference not long ago. A noise sounding like a machine gun was creating tremendous interference. It covered up to 900 kHz, and with multiples of 900 kHz, up to 30 MHz. The source of the noise was finally found to be originating from the telephone lines, with faulty battery chargers at the substations being the cause. The intensity of the interference was great enough to cover local broadcast stations, even though I live more than 6 miles (9km) from the substation. Even after locating the source, it is very difficult to solve the problem because the telephone company is very reluctant to admit blame.

Keith Olson, W7FS
Belfair, Washington



SPECTRONICS, INC.

1009 Garfield St., Oak Park, Illinois • 60304

(312) 848-6777

SELECTED SPECTRONICS VALUES!

\$1000 QUALITY CRYSTALS FOR 2 METERS and 220 MHz

PER PAIR

We are now stocking crystals for most 2-meter pairs and the most popular 220 MHz pairs. If you need crystals for use in any radios listed below, we can normally ship from stock the same day your order is received. These are quality crystals, built to exacting specifications to provide trouble-free operation.

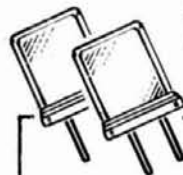

2-METER CRYSTALS

In Stock for: ICOM IC215, IC22A, IC22, IC21 and IC21A.

Wilson: Model 1402 and 1405.

220 MHz CRYSTALS

In Stock for: Midland 509, (Cobra model 200, Clegg 220 unit.)

Wilson: Model 2202.

ORDERING INFORMATION

1. State Brand and model number of transceiver.
2. State frequency pair wanted, indicating transmit frequency first, then receive.

146 MHz PAIRS	147 MHz PAIRS	220 MHz CRYSTAL PAIRS
Transmit/Receive	Transmit&Receive	Transmit/Receive
146.01/146.61	147.99/147.39	222.22/223.82 MHz
146.04/146.64	147.96/147.36	222.34/223.94 MHz
146.07/146.67	147.93/147.33	222.50/224.10 MHz
146.10/146.70	147.87/147.27	222.54/224.14 MHz
146.13/146.73	147.84/147.24	222.94/224.54 MHz
146.16/146.76*	147.81/147.21	223.06/224.66 MHz
146.19/146.79	147.78/147.18	223.18/224.78 MHz
146.22/146.82*	147.75/147.15	223.22/224.82 MHz
146.25/146.85	147.72/147.12	223.26/224.86 MHz
146.28/146.88*	147.69/147.09	223.26/224.86 MHz
146.31/146.91	147.66/147.06/	223.26/224.86 MHz
146.34/146.94	147.63/147.03/	223.30/224.90 MHz
146.34/146.94*	147.30/147.30	223.34/224.94 MHz
146.46/146.46	147.42/147.42/	223.38/224.98 MHz
146.49/146.49	147.48/147.48/	
146.55/146.55	147.51/147.51/	
	147.54/147.54/	
	147.57/147.57/	

Note: Items marked * stocked for Wilson only; / stocked for ICOM only

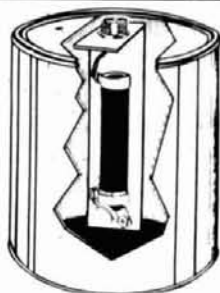

THE BIG DUMMY

\$2950 Full 1 kW Dummy Load

Low-cost dummy load covers the full range from 1.8 to 300 MHz with flat SWR. Vented container; comes with one gallon of high quality industrial-grade, long-life, transformer-type cooling oil. Power capability: 1 kW continuous carrier, 10 minutes; 2 kW PEP, 20 minutes. Duty cycle: 50%. Impedance: 50 ohms non-inductive. VSWR: 1.05:1 or better. Size: 6-5/8" dia. x 7 1/2" high. Wt.: 10 lbs.

SIMPLEX

Transmit/Receive
223.46/223.46 MHz
223.54/223.54 MHz

MOSTEK AUTO-PATCH TONE GENERATOR

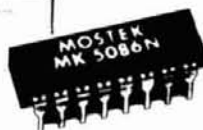
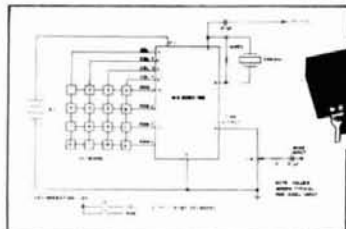

ONLY \$9.00

Economical DTMF generating system combines CMOS logic, D-to-A converters, an operational amplifier and bipolar transistors on a single IC chip. Uses inexpensive 3.58 MHz crystal. Dual tones mix internally. Tones are 14-step synthesized sine waves for low distortion. Compatible with Digitran® keyboard. Common key function outputs. For 5-10 V.

Model MK 5086. Interfaces to either a 2-of-8 keyboard or other electronic systems \$9.00

DIGITRAN KEYBOARD

12 Key
\$8.00

16 Key
\$10.00

LOW PROFILE YET ALMOST STROKE 1/16"

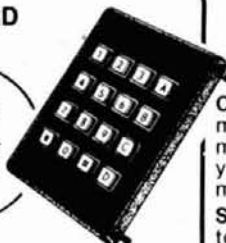

A star value at the Dayton Hamvention. Incorporates the ideal "tactile feel" leaving no doubt that contact has been made. These new keyboards are manufactured by the Digitran Company and are furnished with instructions for combining with a Mostek or Motorola chip and a crystal (plus several small components) to become a Tone Encoder.

12 Key (2 of 7 Matrix) 2" x 2 7/8" x 5/16" \$8.00
16 Key (2 of 8 Matrix) 2 5/8" x 2 7/8" x 5/16" \$10.00

WHEN ORDERING FROM SPECTRONICS, REMEMBER:

C.O.D. ORDERS require payment to be made by cash, certified check, or money order only. We will gladly quote you the exact amount that the deliveryman will ask for.

SHIPPING CHARGES must be added to your order.

ALL ORDERS sent F.O.B. Oak Park, Illinois.



FAMOUS HAM-KEYS... POPULAR FAVORITES FOR CW!

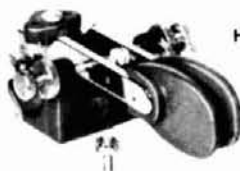

HK-1



HK-3



HK-2

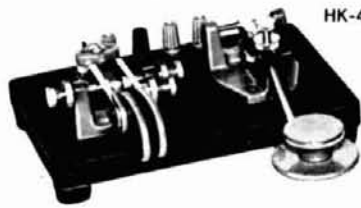

HK-4

Model HK-1 Dual-lever squeeze paddle. Can be used with any electronic keyer. Heavy base has non-slip rubber feet. Paddles are reversible for wide-finger or close-finger spacing

\$29.95

Model HK-2. Same as HK-1 less base. For incorporation in own keyer

\$19.95

Model HK-3. Deluxe straight key. Heavy base so there's no need to attach to desk. Velvet smooth action

\$16.95

Model HK-3A. Same as HK-3, less base

\$9.95

Navy type knob only

\$2.75

Model HK-4. Combines models HK-1 and HK-3. On heavy base with non-slip rubber feet

\$44.95

Base only, with rubber feet. Heavy

\$12.00

Terminals. Red or black

Each \$.75



For literature on any of the new products, use our *Check-Off* service on page 142.

new Drake transceiver



The new TR-7 transceiver from the R.L. Drake Company is the first commercially available amateur transceiver that uses a 48-MHz i-f. This concept allows great flexibility in frequency coverage as well as providing greatly improved image rejection.

Reception through the entire range of 1.5 through 30 MHz is provided by the TR-7, and, with the use of an Aux-7 Range-Program board, the range can be expanded to cover from 0 to 30 MHz. The up-conversion technique, along with the synthesized/PTO frequency control, makes this extended frequency coverage possible.

Full passband tuning is another feature of the receiver portion of the unit. It is possible to tune from the top edge of one sideband, through zero, to the bottom edge of the other sideband. The range is also wide enough to allow tuning through RTTY signals. This ability to place a wanted signal at the proper spot in the filter passband is a great aid when working on the crowded amateur bands.

Further improved reception can be obtained by installing optional receiving-selectivity filters in the rig; you can select the desired filter by pushbutton switches on the front panel. Also, a unique system permits you to select the receiving filter independently of the transmitter mode or function. Thus you can transmit on CW but receive with an ssb filter, or even transmit on one sideband while receiving the other. Optional filter widths include 300 Hz, 500 Hz, 1.8 kHz, or 6 kHz.

On the transmit side of the unit, optional programmable coverage for nonamateur-band parts of the spectrum are available. Proof of license for operation out of the amateur bands must be submitted to the R.L. Drake Company before obtaining these options, however. This feature also takes care of any possible later expansion of the amateur frequencies.

The all-solid-state design and broadband tuned circuits means that there are no preselector or peaking circuits to contend with in the TR-7. The power amplifier is designed for continuous-duty ssb and CW operation. The efficient, internal heat-sink provides enough dissipation in free air for full power on all modes except SSTV or RTTY; these high-duty-cycle transmissions are provided for by an optional fan for extra cooling. The transmitter is rated at 250 watts input on all modes, and the PS-7 ac power supply is designed to provide continuous-duty power for any mode. This supply also accepts input voltages of 90-132 Vac, 180-264-Vac, at 50 to 60 Hz, which makes it ideal for overseas locations. The TR-7 transceiver may also be operated from any nominal 13.6 Vdc supply capable of providing 3 Amps on receive and 25 Amps on transmit.

Additional features of the TR-7 include a digital frequency readout, which will provide accuracy of ± 100 Hz, or an analog readout with ± 1 kHz accuracy when properly calibrated. The digital frequency display

can be used as a test instrument with frequency capability of up to 150 MHz, with access to the counter input through a rear panel connector. Power-output metering is obtained by making the standard S-meter double as a built-in wattmeter/swr indicator.

Here are some of the specifications from the TR-7 brochure:

Dimensions (height, width, depth): 11.6 x 34.6 x 31.7 cm (4.6 x 13.6 x 12.5 in.).

Receiver sensitivity: less than 0.5 μ V for 10 dB S + N/N ratio.

Image and i-f rejection: greater than 80 dB

Power input: 250 watts PEP 1 ssb; 250 watts CW.

Spurious output: greater than 50 dB down.

Harmonic output: greater than 45 dB down.

Intermodulation distortion: 30 dB below PEP.

Undesired sideband suppression: greater than 60 dB at 1 kHz.

A wide range of optional features are available, including a noise blanker, mobile mounting kit, and crystal filters. A speaker in a matching cabinet, and a similarly matching remote vfo, will combine with the TR-7 transceiver to make a complete, attractive, and state-of-the-art amateur station that will set the pattern for years to come.

For more information, see your authorized Drake dealer, or write R.L. Drake Company, 540 Richard Street, Miamisburg, Ohio 45342.

prime components purchasing guide

A new components catalog has just been released by Prime Components Corporation of Hauppauge, New York.

The 36-page illustrated booklet lists many of the small parts often

VLF Converter

All Palomar Engineers products are made in U.S.A. Since 1965, manufacturers of Amateur Radio equipment only.



- New device opens up the world of Very Low Frequency radio.
- Gives reception of the 1750 meter band at 160-190 KHz where transmitters of one watt power can be operated without FCC license.
- Also covers the navigation radiobeacon band, standard frequency broadcasts, ship-to-shore communications, and the European low frequency broadcast band.

The converter moves all these signals to the 80 meter amateur band where they can be tuned in on an ordinary shortwave receiver.

The converter is simple to use and has no tuning adjustments. Tuning of VLF singles is done entirely by the receiver which picks up 10 KHz signals at 3510 KHz, 100 KHz signals at 3600 KHz, 500 KHz signals at 4000 KHz.

The VLF converter has crystal control for accurate frequency conversion, a low noise rf amplifier for high sensitivity, and a multipole filter to cut broadcast and 80 meter interference.

All this performance is packed into a small 3" x 1½" x 6" die cast aluminum case with UHF (SO-239) connectors.

The unique Palomar Engineers circuit eliminates the complex bandswitching and tuning adjustments usually found in VLF converters. Free descriptive brochure sent on request.

Order direct. VLF Converter \$55.00 postpaid in U.S. and Canada. California residents add sales tax.

Explore the interesting world of VLF. Order your converter today! Send check or money order to:

Palomar Engineers

Box 455, Escondido, CA. 92025 • Phone: [714] 747-3343

needed by hobbyists, experimenters, and small development laboratories.

A partial list of items that can be purchased from Prime Components Corporation includes cleaning and servicing chemicals, test equipment, tools, integrated circuits, diodes, transistors, capacitors, resistors, LEDs and LED displays, lamps, and fuses. All of the parts are brand-name manufactured, and are available from stock. The catalog is free, and there is a minimum order requirement of \$25.

To receive your free catalog, write to Prime Components Corporation, 65 Engineers Road, Hauppauge, New York 11787.

tandy computers catalog

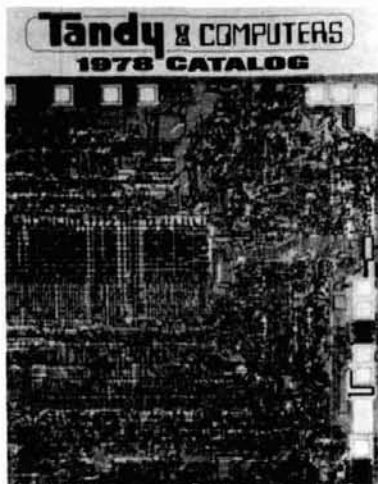

A microcomputer mail-order catalog has just been issued by Tandy Computers, the newly created retail division of Tandy Corporation, parent company of the nationwide Radio Shack electronics store chain. The 52-page, four-color catalog details a full line of popular brand microcomputers and accessories, software packages, parts, and literature currently in stock. Both kits and fully assembled microcomputer systems are listed in the catalog, at prices that range from several hundred dollars to more than \$20,000.

Among the nationally known

ALL-MODE VHF amplifiers

FOR BASE STATION & REPEATER USE



MODEL	INPUT	OUTPUT	PRICE
V70	10-20W	70-90W	\$298
V71	1-5W	60-70W	\$329
V130	25-40W	110-130W	\$389
V131	1-5W	110-130W	\$419
V135	5-10W	110-130W	\$419
V180	8-15W	180-200W	\$525
Universal 19" Rack Mount			\$25

* All units: Harmonics exceed -60 dB specification of FCC R&O 20777

- ☆ 143-149 MHz No Tuning
- ☆ AM - FM - CW - SSB
- ☆ Low Harmonics
- ☆ Heavy Duty
- ☆ No Power Supply Needed
- ☆ Illuminated Panel Meter
- ☆ + 13.5V/3 Amp Socket
- ☆ 115 or 230V AC
- ☆ 60dB Spurious
- ☆ Fully Protected Output
- ☆ Internal T/R Switch
- ☆ U.S. Manufactured
- ☆ 19" Rack Panel Option
- ☆ Size 8-1/2 x 13 x 7" H

Only two things are needed to put this power house on the air with your handy-talky or mobile transceiver: a two foot piece of coaxial cable and a 115 or 230 volt AC outlet. That's all. You do not need anything else. The mobile transceiver can be powered directly from the accessory socket located in the rear panel of the RFPL amplifier. It puts out +13.5 volts at 3 amperes. This is sufficient for powering most 15 watt transceivers.



DEALER INQUIRIES INVITED



RF POWER LABS, INC.

11013-118th Place N.E. • Kirkland, Washington 98033 • Telephone: (206) 822-1251 • TELEX No. 32-1042

brands carried by Tandy Computers are Radio Shack's TRS-80, the IMSAI 8080, Vector 1 and 1+, Xitan, Equinox 100, Polymorphic System 8813, and many others offering beginners, hobbyists, educators, and business users a wide selection from which to choose.

In addition, the store carries a complete selection of microprocessor mainframes, peripherals, software, printed-circuit accessories, discrete parts, and literature. The new store also offers programming assistance and on-premises computer service by skilled technicians.

Copies of the new Tandy Computers 1978 Catalog are available by telephoning toll-free 800-433-1679, by writing to Tandy Computers, Dept. R7, P.O. Box 2932, Fort Worth, Texas 76101.

amphenol solderless coax jack assembly

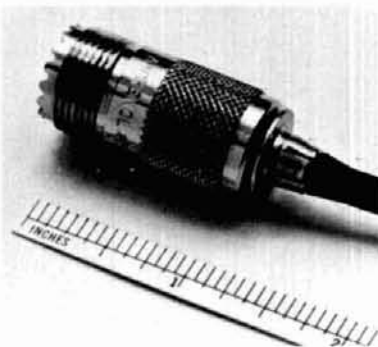

A new Amphenol in-line UHF coax cable jack that can be installed in seconds without special tools or solder has been announced by the RF Operations of Amphenol North America Division, Bunker Ramo Corporation. Developed as a follow-up to last year's introduction of the Amphenol no-solder PL-259 connector for RG-58/U, the new companion in-line splice jack also uses the innovative FCP termination approach, resulting in an extremely fast cable termination — less than 20 seconds.

Whenever an in-line antenna or hookup coax cable splice is needed, the user has only to strip the cable,

DIPLOLE ANTENNA CONNECTOR



HYE-QUE (HQ-1) dipole connector has coax SO-239 socket molded into glass filled plastic body to accept coax PL 259 plug on feedline. Drip-cap keeps coax fittings dry. Instructions included. Guaranteed. At your dealers or \$4.95 postpaid. Companion insulators 2/\$3.99.

BUDWIG MFG. Co. PO Box 97H, Ramona, CA 92065

K-ENTERPRISES

Frequency Counters
Prescalers
Marker & Peaking
Generators

Power Supplies
Amplifiers
Frequency
Standards

Write for Free Catalog

Box 410 (Pump Sta. Rd.) Fairland, OK 74343
Phone: 918-676-3752

ALL BAND TRAP ANTENNAS!



ALL 5 BAND OPERATION - ONLY ONE NEAT SMALL ANTENNA. FOR CONGESTED HOUSING AND APARTMENT DWELLERS! LIGHT, NEAT - ALMOST INVISIBLE!

COMPLETE Ready to put up with 30 ft. Dacron end support cords! Wt. 3 lbs., 1"X5" MOLDED RESONANT TRAPS - just switch your transmitter to desired band for EXCELLENT PERFORMANCE! NO TUNERS OR BALUNS NEEDED! CAN BE USED IN ATTICS, TOPS OF BUILDINGS, INVERTED V's IN MINIMUM SPACE. NO CENTER SUPPORT NEEDED, NO HAYWIRE HOUSE APPEARANCE COMPLETELY ASSEMBLED. No tuning - cutting - soldering - measuring - JUST HANG IT, AND USE IT! SWR IS 1.2 AT RESONANCE THOUSANDS IN USE - EASIEST INSTALLATION!

80-40-20-15-10 meter bands---102 ft. with 90 ft. RG58U coax - connector - Model 998BU... \$49.95
40-20-15-10 meter bands---54 ft. with 90 ft. RG58U coax - connector - Model 1001BU... \$48.95
20-15-10 meter bands---26 ft. with 90 ft. RG58U coax - connector - Model 1007BU... \$47.95

Send only \$5.00 (cash, ck., mo.) and pay postman balance plus COD postage OR SEND FULL PRICE FOR POST PAID DEL. IN USA (Canada is \$5.00 extra) or order by MAIL OR PHONE with Bank - Americard VISA - MASTER CHARGE - OR AM EXP. Give number and ex. date. Ph 1-308-236-5333 week days. We ship in 2-3 days. INFLATION? PRICES MAY INCREASE - SAVE - ORDER NOW! INFO. AVAILABLE FROM: WESTERN ELECTRONICS Dept. AH-6 Kearney, Nebraska, 68847

insert the center conductor into the back of the connector, and slide the ferrule into place. Once accomplished, termination is complete. The result is a handy, in-line SO-239 receptacle that will directly accept any PL-259 plug. All need for a second PL-259 connector plus PL-259 to PL-259 adapter has been eliminated.

Called the Amphenol UHF Cable Jack 83-58FCJ, the new device easily handles all power levels up to maximum ratings of the RG-58/U coax cable itself. The 83-58FCJ connector adapters have a frequency range of 0-300 MHz, and a voltage rating of 500 volts peak. And, unlike conventional solder connection techniques, the 83-58FCJ can be easily disassembled and reused. It also has standard 5/8-24 threads for simple, screw-on mating with conventional UHF plugs.

Manufactured by Amphenol exclusively in the United States, the new jacks are machined from brass rod stock and plated with *Astrolite*[®], lustrous, non-tarnish finish. For more information, contact Bunker Ramo Corporation, 33 East Franklin Street, Danbury, Connecticut 06810.

turner personal communications catalog

The Turner Division of Conrac Corporation now has available a newly revised personal communications catalog. The catalog is all inclusive, containing Turner's entire personal communications product line. Twenty-eight pages in size, the new catalog has sections on microphones, stainless steel antennas, fiberglass antennas and accessories. Previously, Turner had separate catalogs for each product line.

The four-color catalog features a section on Turner's new no-solder microphone connector program, "The Turner Connection." The catalog contains general information and engineering specs to aid the distri-



INTRODUCES THE VERSATILE NEW



HR-312

- More Channels...at the flip of a switch**
 Unlock the unique mode switch and 12 channels become 144
- More Sensitivity, Less Interference.**
 .25 μ V Sensitivity plus 75 db adjacent channel selectivity and 70 db image rejection
- More Power Out**
 35 watts nominal with a minimum of 30 watts across the band

... for a lot less

\$269⁰⁰

Amateur Net



© 1976 **Regency ELECTRONICS, INC.** 7707 Records Street
Indianapolis, Indiana 46226

THE FM LEADER



2 METER

6 METER



220 MHz

440 MHz

**AMECO • ARRL BOOKS • ASTATIC • B & W • BEARCAT
• CALLBOOK • CDE HAM III • CUSHCRAFT • DENTRON
• HALLICRAFTERS • HY-GAIN • KLM • LARSEN
• MALLORY • J. W. MILLER • MOSLEY • SAY POWER
SUPPLIES • SHURE • W2AU BALUN • MORE TO COME!**

Orlando's Most Complete Stock of Electronic Hardware

Transistors • Diodes • Integrated Circuits • Variable Capacitors • Connectors • Audio Cables
• Variable Resistors • Antenna Wire • RG-8/U Coax (foam) • Rotor Cable • Steel Mast
• Ceramic Insulators • and much more

LAFAYETTE RADIO ELECTRONICS

1811 N. HWY 17-92, MAITLAND, FL. 32751

(Near Orlando)

305-831-2271

ASSOC.
STORE



NEWS Update

from **DRAKE**

Glad you asked...



TR-7 SYSTEM:

The new TR-7 System is an addition to the Drake line. The Drake C-Line with its accessories is continuing to be produced.

The TR-7/DR-7 features continuous reception from 1.5 thru 30 MHz and transceive 160 thru 10 meter Amateur Bands. For reception from 0 thru 1.5 MHz use the optional AUX-7 Range Program Board and an RRM-7 Receive Module for each 500 kHz segment to be covered. Each RRM-7 plugs directly into the AUX-7 board and is selected from the front panel.

Out-of-band transmit for MARS, etc., is accomplished by plugging an RTM-7 Transceive Module into the AUX-7 for each 500 kHz segment to be covered. Proof of license is necessary to purchase transceive modules.

The MN-7 Antenna Matching Network covers the Amateur Bands from 160 thru 10 meters; matches balanced lines, long wires, and coax-fed antennas; features a built-in RF Wattmeter/VSWR Bridge; and has complete switching functions.

The MN-4C Antenna Matching Network offers the same features, but is styled to match the 4-Line/C-Line.



UV-3 SYSTEM:

The UV-3 System is fully synthesized to 5 kHz on each of the bands it covers. Among other firsts, it is presently the only rig in the world synthesized on 440 MHz fm.

There is a separate SO-239 Coax Connector for each band, so a choice of antennas may be used.

Extra fixed channels and special offsets are diode-programmable, so crystals are not necessary at all.

These thoughts of interest are provided by Drake,

"The Newsmakers"

To receive a FREE Drake Full Line Catalog, please send name and date of this publication to:

R. L. DRAKE COMPANY



DRAKE

540 Richard Street, Miamisburg, Ohio 45432 • Phone (513) 866-2421 • Telex 288-017

Western Sales and Service Center, 2020 Western Street, Las Vegas, Nevada 89102 • 702/382-9470

butor/dealer in promoting Turner products.

This new catalog encompasses all the changes and additions that Turner has made to its personal communications product line so that it is an up-to-date promotional tool as well. For more information, write to Turner, 716 Oakland Road, North East, Cedar Rapids, Iowa 52402.

high-power VHF mobile antennas



LAND MODEL
2000 WATT
22-14 300
TYPE 110-1000

A line of mobile antennas with high power ratings, covering the six and two-meter frequency ranges, has been introduced by Antenna Incorporated. The six-meter antennas feature 200-watt loading coils; the two-meter antennas are available with either 150 or 200-watt loading coils. They are available with 3/4-inch toggle mounts, cowl mounts, and no-hole trunk-lip mounts. Also available are 100-watt models with either the same mounts, or with 3/8-inch snap-in, spring-clip gutter, and magnet mounts. Loading coils are tuned at the factory to achieve a standing wave ratio of 1.5:1 or less, and each antenna includes a cutting chart so the whips can be field trimmed to exact frequencies.

Each antenna features a plated stainless steel whip for low resistivity to combat skin effect, stainless steel impact spring, shock-resistant and

weatherproofed PVC-wrapped loading coil, and 17 feet of coaxial cable with a soldered PL-259-type connector.

The 200 watt two-meter antennas also feature Antenna Incorporated's new high-power coaxial cable. While the 150 watt high-band and 200 watt low-band antennas include RG/58-U cable, this cable cannot safely handle 200 watts of power on two meters. Antenna Incorporated's high-power cable has performance characteristics similar to RG-8/U, but in a smaller size, thus eliminating the problems of using the larger cable in mobile applications.

"These antennas also are part of Antenna Incorporated's professional land mobile line and have been designed to meet the needs of high power communications users," sales manager Randall Friedberg said. "They offer the amateur the best in antenna quality and dependability."

For further information on the company's complete line of communications antennas and accessories, contact Randall J. Friedberg, Antenna Incorporated, 23850 Commerce Park Road, Cleveland, Ohio 44122. Phone (216) 464-7075.

hallicrafters H2M-1000 two-meter transceiver

Hallicrafters Company, a long-time manufacturer of amateur radio equipment and systems, has announced the introduction of its new two-meter PLL frequency synthesized multi-mode transceiver. Hallicrafters' new H2M-1000 is designed to operate in fm, usb, lsb, and CW modes. In the fm mode, the H2M-1000 provides 800-channel coverage (5 kHz steps) and a vxo variation of ± 7 kHz in the ssb/CW modes. The H2M-1000 also features simplex and repeater off-sets of ± 600 kHz and ± 1 MHz for fm.

The H2M-1000 provides easy read-out with a six-digit, seven-segment, light-emitting diode (LED) frequency display in the fm mode and five-digit display in single sideband (ssb) mode.

PUNCH UP



Your

Most Called Numbers with a Single Key Punch!

Now you can dial up to 18 complete 7 or 8-digit phone numbers by punching only one (or two) keys on your pad.

The AD-1 Auto Dialer's 10 number capacity RAM can be completely programmed from its own pad in less than a minute.

The optional field - installable factory-programmed PROM adds 8 more numbers for \$4.95.

The AD-1 is ideal for mobile autopatches, home or business use. It features a unique MOS microprocessor which permits both tone duration and spacing to be programmed along with the numbers, adding versatility for repeater or similar control functions. Its crystal controlled tone generator assures high stability over a wide temperature range. The AD-1 is fully automatic and foolproof in operation. Coil cord provides convenient connection to your rig. See it at your Amateur Radio distributor or use the coupon below today.

AEA

Advanced Electronic Applications, Inc.
P.O. Box 2160, Lynnwood, Washington 98036

Available From The Following Fine Dealers

Long's Electronics
2808 Seventh Avenue South
Birmingham, AL 35233
(205) 252-7589
(205) 252-8085

Power Communications
6012 N. 27th Avenue
Phoenix, AZ 85017
(602) 242-6030

Henry Radio, Inc.
931 N. Euclid
Anaheim, CA 92801
(714) 772-9200

Ham Radio Outlet
2620 W. La Palma
Anaheim, CA 92801
(714) 761-3033
(213) 860-2040

Ham Radio Outlet
999 Howard Avenue
Burlingame, CA 94010
(415) 342-5757

Henry Radio, Inc.
11240 West Olympic Blvd.
Los Angeles, CA 90064
(213) 447-6701

Ham Radio Outlet
5375 Kearny Villa Road
San Diego, CA 92123
(714) 560-4900

Ham Radio Outlet
13754 Victory Boulevard
Van Nuys, CA 91401
(213) 988-2212

Amateur Electronic Supply
621 Commonwealth Avenue
Orlando, FL 32803
(305) 894-3238

CW Electronics
1401 Blake Street
Denver, CO 80202
(303) 893-5525

Erickson Communications
5935 North Milwaukee Avenue
Chicago, Illinois 60646
(312) 631-5181

Tufts Electronics Radio
209 Mystic Avenue
Medford, MA 02155
(617) 395-8280

Electronic Distributors
1960 Peck Street
Muskegon, MI 49441
(616) 726-3196

Henry Radio, Inc.
211 North Main Street
Butler, MO 64730
(816) 679-3127

Conley Radio Supply
318 North 16th Street
Billings, MT, 59101
(406) 259-9554

Communications Center
2226 North 48th Street
Lincoln, NE 68504
(402) 466-8402

Universal Amateur Radio
1280 Aida Drive
Reynoldsburg, OH 43068
(614) 866-4267

Amateur Electronic Supply
28940 Euclid Avenue
Wickliffe, OH 44092
(216) 585-7388

Kennedy Associates
2618 Rigsby Avenue
San Antonio, TX 78222
(512) 333-6110

C-Comm
6115 15th Avenue, NW
Seattle, WA 98107
(206) 784-7337

G. D. S. Electronics
West 3711 Strong Road
Spokane, WA 99208
(509) 328-0133

Amateur Electronic Supply
4828 West Fond du Lac Avenue
Milwaukee, WI 53216
(414) 442-4200



Advanced Electronic Applications, Inc.

P.O. Box 2160, Lynnwood, Washington 98036

Name _____ Call _____

Address _____

City _____

State _____ Zip _____



Please send _____ AD-1 Auto Dialers at \$129.95

NOTE: Mail orders add \$2.00 shipping/handling; Washington residents include 5.4% state sales tax.

Check or money order for \$ _____ enclosed

Charge my VISA/Master Charge # _____

Card expiration date _____

Signature _____

MFJ INTRODUCES A NEW 24 HOUR DIGITAL CLOCK

with **HUGE 1-5/8 inch digits** that you can keep set to GMT.
Alarm and snooze functions let you use it as an ID Timer.
Assembled, too!



\$29⁹⁵

**BRAND
NEW**

MFJ Enterprises brings you a new 24 hour digital alarm clock with HUGE 1-5/8 inch orange 7 segment digits that you can see clear across the room.

This one is strictly for your ham shack, one that you can leave set to GMT. No more mental calculations to get GMT.

Use the alarm to remind you of a SKED or with the snooze function as an ID timer to buzz you in 8 minute intervals.

A constantly changing kaleidoscopic pattern indicates continuous operation.

Beige. 2-1/4 x 4-1/8 x 8-3/4 inches. UL listed. Requires 120VAC, 60Hz.

Order from MFJ and try it — no obligation. If not delighted, return it within 30 days for a re-

fund (less shipping). One year limited warranty by MFJ Enterprises.

To order, simply call us toll free 800-647-8660 and charge it on your VISA or Master Charge or mail us a check or money order for \$29.95 plus \$2.00 for shipping and handling.

Don't wait any longer to enjoy the convenience of a "Hams Only" clock. Order today.

MFJ ENTERPRISES

P. O. Box 494
Mississippi State, MS 39762

Call Toll Free 800-647-8660

For order status and repair status and in Mississippi, call 601-323-5869.

The **SEVEN-SYSTEM** is all you need!

DRAKE TR-7

An Engineering Breakthrough for the finest
in Solid-State Transceiver performance.

Covers 10 - 160 meters*
Frequency Counter to 150 MHz
with digital option

Broadband, solid-state design
Designed & manufactured
in U.S.A.

Programmable auxiliary coverage
250-watt input with full VSWR
protection

Up-conversion receiver for
superior dynamic range
True passband tuning



Synthesized PTO
CW SSB RTTY AM capability

Matching Accessories:

Remote VFO
Matching Speaker
Digital read-out board
120/240-volt wide-range
power supply

AM filter
RTTY filter
2 CW filters, 300 Hz, 500 Hz
Fan (for RTTY)
Noise blanker

Independent receive selectivity
Built-in VSWR/watt/S-meter

Mobile mount
Antenna tuner/wattmeter
Wattmeter/VSWR bridge
Aux-7 Expanded receive
Capability

*includes capability for MARS, Embassy, and Government frequencies, and possible future Amateur-Band expansion. Receiver coverage continuous from 1.5 - 30 MHz, and 0 - 1.5 MHz with Aux-7.

Call Now to find out how easy it is to put a new DRAKE TR-7 in your shack.

Hams Serving Hams Since 1939

ELECTRONIC DISTRIBUTORS, INC.

1960 PECK STREET
TELEPHONE (616) 726-3196

MUSKEGON, MICHIGAN 49441
TELEX 22-8411

The H2M-1000 can be operated on either ac or dc and has two panel meters; a combination S and rf power output plus a discriminator meter. The rf power output is in excess of 10 watts in the high-power mode and one watt in low-power mode. Other features include a noise blanker switch, an agc recovery switch (standard and slow agc), mike gain control, a built-in vox, and receiver incremental tuning (RIT). For additional information, contact the Hallicrafters Company, 2501 Arkansas Lane, Grand Prairie, Texas 75051.

hammond diecast utility boxes

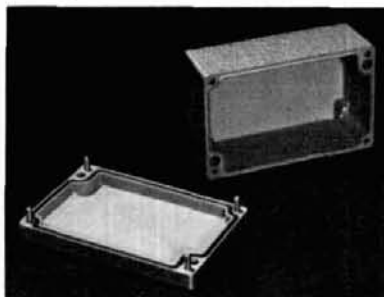

Hammond Manufacturing has introduced two new water and corrosion-resistant utility boxes, 12.5 x 7.9 x 5.6 cm (4.9 x 3.1 x 2.2 inches) and 22 x 12 x 7.9 cm (8.7 x 4.7 x 3.1 inches). Diecast in an aluminum alloy, they have an exceptionally good finish, unmarred by closure screws which have been recessed into the lid. The color is baked on Hammer-tone Grey enamel.

Sealing is facilitated by an interlocking flange and neoprene rubber ring inset in the lid. Both models come with two bolt holes outside of the sealing ring and concealed beneath the lid for attractive and secure mounting of the box. Electrical, rf shielding, and environment protection are some of the many applications for these products. For more information, contact Larry Humphries, Hammond Manufacturing Company, Inc., 385 Nagel Drive, Buffalo, New York 14225.

TOO STRONG TO GIVE THE WIND A BREAK!

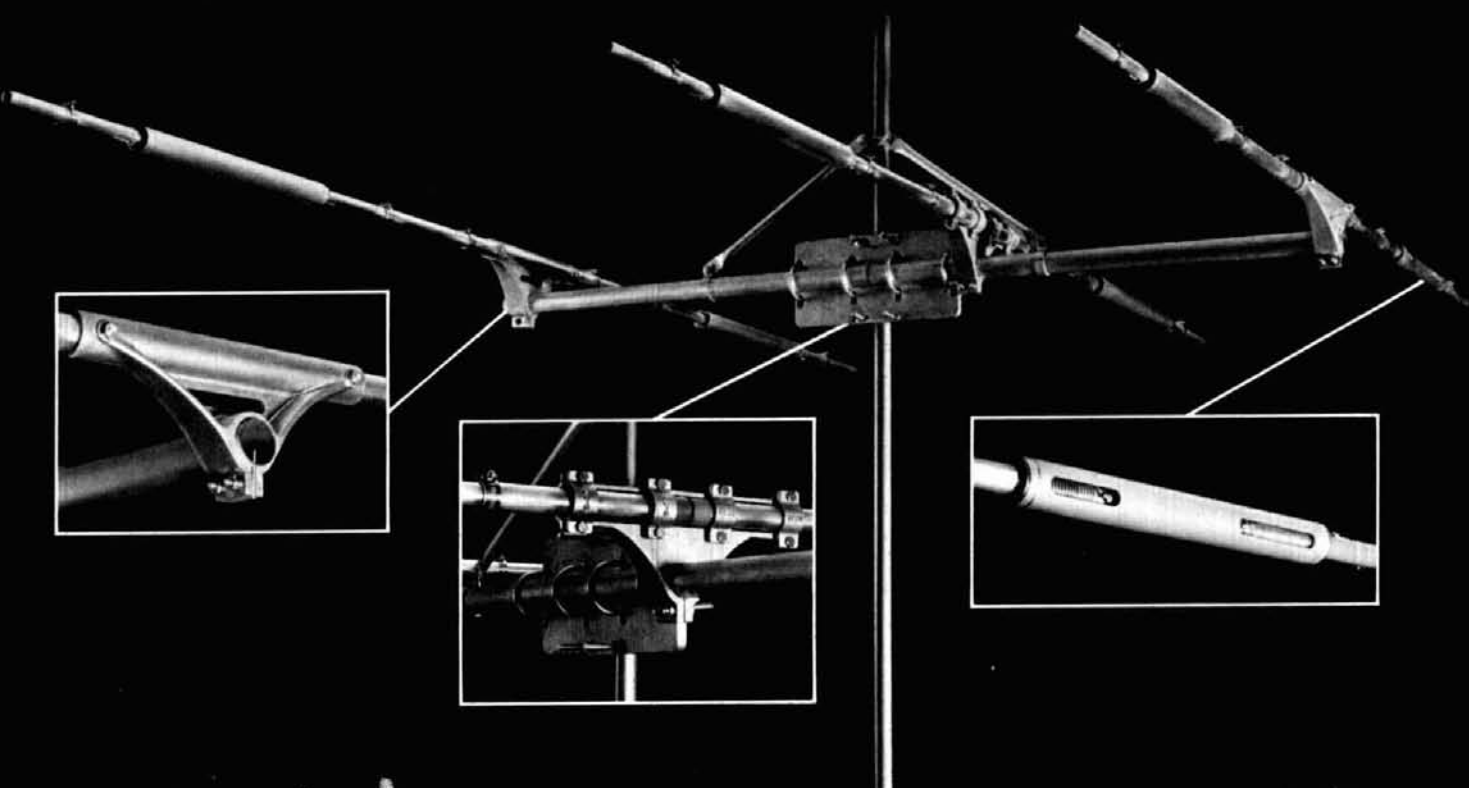

Braced against the elements as only Swan can do it! Even hurricane winds to 100 MPH can't lower the boom on your operations.

The Swan TB3HA Tri-Bander: a really heavy-duty 20-15-10 meter beam. 3 solid elements, all work-

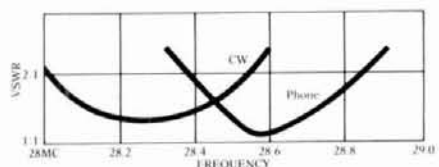
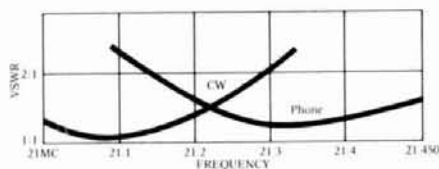
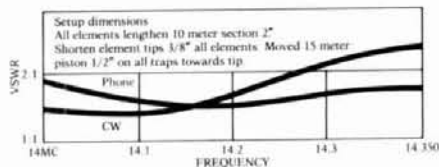

ing on all bands. With a VSWR of 1.5:1 or better at resonance, plus a full 2000-watt PEP rating, our TB3HA is built to work up a storm!

Strongest fittings available: this you've got to see. Exclusive cast-aluminum braces grasp tubes at every joint, spreading stress over an 11 3/4" span. Compared to slipshod U-bolt plates—no contest!

Reinforced by super specs, TB3HA's one tough competitor:

- 8dBd average forward gain.
- 20-22 dB front to back ratio.
- 16' turning radius.
- longest element: 28'2"
- 16' boom, optimum spacing.
- direct 52 Ohm coaxial feed.
- wind load @ 80 mph: 110 lbs.
- 44 lbs. net weight.
- \$199.95 complete, Swan Credit Card accepted.

For \$199.95 at your local Swan dealer you can start operating tri-band from a position of real

strength—because TB3HA is Swan-engineered to work under pressure!

Please rush full information on Swan's Heavy Duty Tri-Band Beam Antennas:

- 3-element TB3HA
- 4-element TB4HA

Name _____

Address _____

City _____

State _____ Zip _____

FREE! Personalized call-letter plaque



2 1/4" x 4" with stand, no charge.

Please send my plaque encribed with my station call

SWAN
ELECTRONICS
a subsidiary of Cubic Corporation

305 Airport Road, Oceanside, CA 92054
Swan's continuing commitment to product improvement may affect specifications and prices without notice.

8-POLE 350-Hz FILTER FOR SIGNAL/ONE TRANSCEIVERS \$120.00

Finally! Superior 8-Pole CW Selectivity for Drake TR-4, TR-4C, TR-4 Cw

350 Hz at -60db, 850 Hz at -60db. Cuts QRM. More selective than 6-pole CW filter in new TR-4Cw which is 500 Hz at -6db, and 2000 Hz at -60db. CF-350/B \$100.00. Switch and mounting kit \$10.00

At Last! Superior 8-Pole CW Selectivity for Kenwood TS-820

MINIMAL LOSS IN SET. GOOD SIGNAL-TO-NOISE. 350 Hz at -6db, 850 Hz at -60db. Cuts QRM. More selective than standard YG-88C 6-pole CW filter which is 500 Hz at -6db, and 1800 Hz at -60 db. CK-350/B \$100.00

600 Hz 6-Pole First-IF Filter for Drake R-4C

Improve the early stage selectivity. Eliminate those high pitched beat notes from signals that leak around the switcheable second-IF filter. Minimize the chance of strong signals overloading the second mixer, causing intermodulation and desensitization. Both the existing filter and our CF-600/B can be mounted in the receiver and relay switched to retain phone capabilities. CF-600/B \$80.00. Relay switch kit \$33.00

125 Hz 8-Pole Second-IF Filter for Drake R-4C

Still sharpest available! 300 Hz at -60db! Cuts QRM. Ideal for DX and contest work. Unexcelled under crowded band conditions. Does what no audio filter can do. More selective than audio filters. Puts selectivity in AGC loop. Unlike with audio filters, receiver gain not reduced by QRM outside passband. Yet works well with an audio filter to improve receiver performance. Plug directly into an accessory filter socket of the R-4C. CF-125/B \$130.00

CW Operators!
Attention:
These crystal filters are for you!

All filters contain specially-treated high-Q crystals.

Sherwood Engineering Inc.
1268 South Ogden St.
Denver, Colo. 80210
(303) 722-2257

Money back if not satisfied

Add \$3 per order shipping;

\$6 overseas air

Dealer Inquiries Welcome



VIDEO TERMINAL
MODEL 795 VIDEO DISPLAY TERMINAL



With 7x10" magnetically-deflected CRT. With internal DC-to-DC converter, 10 KV supply, horiz. and vert. deflection amps, and internal muffin fan. Controls for intensity, vert. and horiz. gain/position. Requires 115 VAC 60 Hz. Less power cord. 15 1/2 x 17 1/2 x 21"; Sh. Wt. 100 lbs. Used, Repairable **\$59.50**

KSR-33 TELETYPEWRITER and KEYBOARD - 100 WPM, 600 operations per sec. Utilizes ASCII code with parity bit; 8 1/2" sprocketed paper. 115 VAC 60 Hz. 8 1/2 x 18 3/4 x 18 1/2"; Sh. Wt. 50 lbs. Used, operational, but may require some adjustment. Less cover, **\$250**. With cover, **\$300**.

SPDT ANTENNA CHANGEOVER RELAY
Heavy silver contacts good for at least 500 watts. Coil: 6 V 60 Hz 1 ohm. Requires three "N" connectors. 3x3 1/2 x 1; 2 lbs. sh. wt. #0-901/T-282. Used, **\$9.95**



R-390A RECEIVER
0.5-32 Mhz digitally-tuned; 95 lbs. sh. Reconditioned **\$695.00**

NEMS-CLARKE 1502 RECEIVER
55-260 Mhz AM, FM, CW; 50 lbs. sh. Used, repairable w/manual **\$275.00**

Write for New Catalog WS-78 - Government and Commercial Electronic Surplus
All Prices F.O.B., Lima, Ohio
Please make allowance for shipping charges!
Use your VISA, BAC or Master Charge card.
Address Dept. HR • Phone: 419/227-6573

FAIR RADIO SALES
1016 E. EUREKA • Box 1105 • LIMA, OHIO • 45802

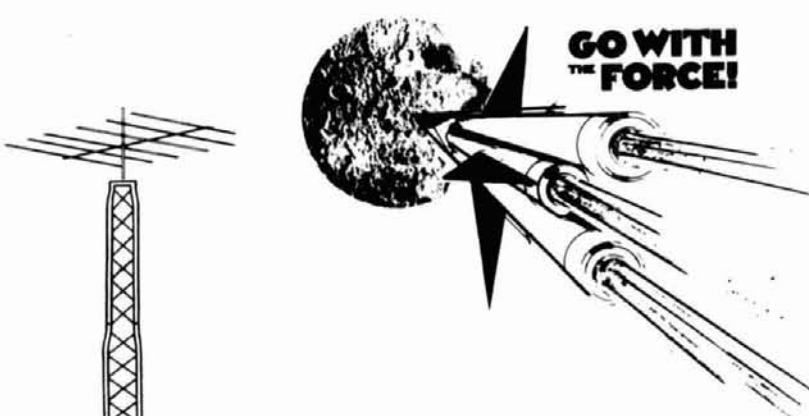

Rohn is the TOWER FORCE when it comes to building towers — look at the BX Towers and you'll see why . . .

- HDBX Towers will hold up to 18 sq. ft. antenna capacity.
- Due to design, BX Towers hold greater antenna loads than competitive models.
- Can be assembled on the ground and hinged up or built vertically, section upon section.
- Shipped nested
- Fabricated in U.S.A.

Check out the ROHN TOWER FORCE, you'll be glad you did!

Unarco-Rohn

Division of Unarco Industries, Inc.
6718 West Plank Road, P.O. Box 2000
Peoria, Illinois 61656

PCP™ TYPE-A PATENT PENDING

SEE POPULAR ELECTRONICS FEB '78 ISSUE!

FINALLY you can make HIGH QUALITY printed circuit boards directly from magazine construction articles! Can also be used to make specialized meter faces, front panel decals, component placement decals & others.

(Kits Available)
Small Pkg. 6pcs 4x6 \$5.49
Med. Pkg. 4pcs 6x9 \$6.95
Large Pkg. 3pcs 9x12 \$7.95

PCP PRINTED CIRCUIT PRODUCTS CO
P.O. BOX 1033
MELINA, MI 48661

GROTH-Type
COUNTS & DISPLAYS YOUR TURNS

- 99.99 Turns
- One Hole Panel Mount
- Handy Logging Area
- Spinner Handle Available

Case: 2x4"; shaft 1/4"x3"

PRICES POST PAID
TC 2 — \$8.00 Model TC2: Skirt 2-1/8"; Knob 1-5/8"
TC 3 — \$8.75 Model TC3: Skirt 3"; Knob 2-3/8"
Spinner (\$) — \$1.00
Add \$0.75 for Air or UPS

R. H. BAUMAN SALES
P.O. Box 122, Itasca, Ill. 60143

BUILT FOR ACTION FROM THE GROUND UP

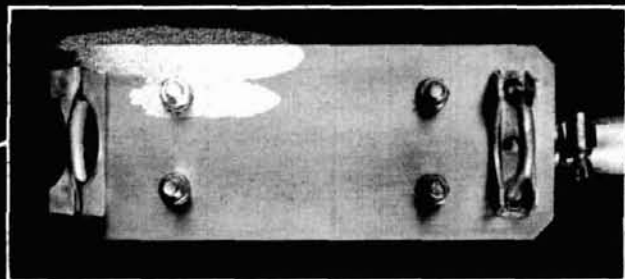
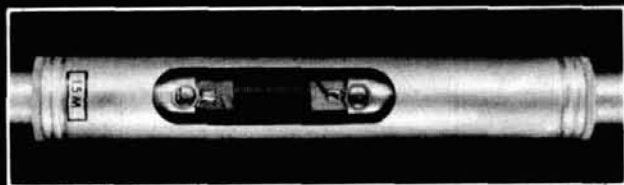

If you've got a calling for far-reaching action, have we got a number for you!

Swan's 4010V: precision engineered for 40-20-15-10 meters.

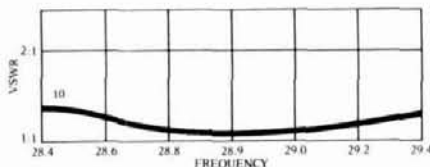
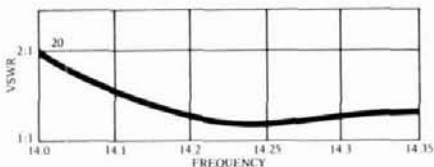
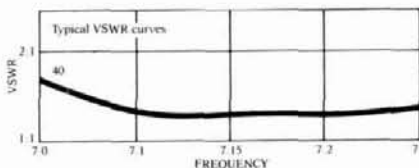

With slim-line traps, this 4-band vertical offers advanced light-weight construction *with heavy weight* performance.

4010V's fine-tuned to handle 2000 PEP. With a typical VSWR of 1.5:1 at resonance.

Powerfully designed — yet powerfully simple to set up.

No-hassle installation. The 21' vertical comes in short, easy to assemble lengths. Complete with mounting hardware. You're up and running in record time.

Expandable too. No trick at all to stretch your reach into 75 meters, with the optional Swan 75 AK Kit.

Just \$74.95 for an outstanding 4-band trap vertical, the 4010V

(and \$39.95 for the 75-meter add-on kit), at your Swan dealer. And by all means, use your Swan Credit Card.

Please rush full specs for Swan's

- 4010V 4-band trap vertical antenna
- 75 AK 75-meter Kit

Name _____

Address _____

City _____

State _____ Zip _____

FREE! Personalized call-letter plaque

2 1/2" x 4" with stand, no charge

- Please send my plaque imprinted with my station call



SWAN
ELECTRONICS
a subsidiary of Cubic Corporation

305 Airport Road, Oceanside, CA 92054

Swan's continuing commitment to product improvement may affect specifications and prices without notice.

State
of the art



by
K.V.G.

CRYSTAL FILTERS and DISCRIMINATORS

9.0 MHz FILTERS

XF9-A	2.5 kHz	SSB TX	\$33.55
XF9-B	2.4 kHz	SSB RX/TX	\$47.75
XF9-C	3.75 kHz	AM	\$51.40
XF9-D	5.0 kHz	AM	\$51.40
XF9-E	12.0 kHz	NBFM	\$51.40
XF9-M	0.5 kHz	CW (4 pole)	\$35.95
XF9-NB	0.5 kHz	CW (8 pole)	\$63.95

Export
Inquiries
Invited

9.0 MHz CRYSTALS (Hc25/u)

XF900	9000.0 kHz	Carrier	\$4.15
XF901	8998.5 kHz	USB	\$4.15
XF902	9001.5 kHz	LSB	\$4.15
XF903	8999.0 kHz	BFO	\$4.15
F-05	Hc25/u	Socket Chassis	.50
F-06	Hc25/u	Socket P.C. Board	.50

Shipping
\$1.25
per filter

ALSO AVAILABLE FROM KVG

10.7 MHz CRYSTAL FILTERS AND XTAL DISCRIMINATORS

OSCILLATOR CRYSTALS 50 kHz TO 150 MHz

Write for Details

PRE-SELECTOR FILTERS



ELIMINATE IMD "BIRDIES"
FROM YOUR RECEIVER.
CLEAN UP YOUR TRANS-
MITTER OUTPUT. VERY
LOW LOSS, 0.15 dB
TYPICAL.

432 MHz PSf432	\$39.95
1296 MHz PSf1296	\$39.95
1691 MHz PSf1691	\$52.45
Shipping	\$3.50

RECEIVE CONVERTERS



MODELS FOR ALL BANDS 50 MHz
THRU 1296 MHz. LOW NOISE OP-
TIONS AT 432 MHz.

STANDARD I.F. 10M. IF OPTIONS 6M & 2M
POWER 12V D.C.

Shipping \$2.50

MMc144	N. F. 2.8 dB typ.	\$49.95
MMc432	N. F. 3.8 dB typ.	\$59.95
MMc438/ATV	Ch2 or Ch3 IF	\$79.95
MMc1296	N. F. 8.5 dB typ.	\$69.95

ANTENNAS (FOB CONCORD, VIA UPS)

144-148 MHz J-SLOTS

8 OVER 8 HORIZONTAL POL.	+12.3 dBd	D8/2M	\$45.95
8 BY 8 VERTICAL POL.		D8/2M-VERT.	\$53.95
8 + 8 TWIST	\$47.65		



420-450 MHz
MULTIBEAMS

48 EL.	GAIN +15.7 dBd	70/MBM48	\$49.95
88 EL.	GAIN +18.5 dBd	70/MBM88	\$73.50

UHF LOOP YAGIS

26 LOOPS	GAIN +20 dBi		
1250-1340 MHz	1296-LY		\$56.95
1650-1750 MHz	1691-LY		\$63.95

Send 26¢ (2 stamps) for full line catalogue of KVG crystal products and
all your VHF & UHF equipment requirements.

Pre-Selector Filters	Amplifiers	SSB Transverters
Varactor Triplers	Crystal Filters	FM Transverters
Decade Pre-Scalers	Frequency Meters	VHF Converters
Antennas	Oscillator Crystals	UHF Converters

si

Spectrum
International, Inc.
Post Office Box 1084
Concord, Mass. 01742, USA

TPL 1/4 KILOWATT LINEAR AMPLIFIER

TPL proudly presents the first true power 1/4KW

SSB/AM, FM or CW solid state
2 meter linear amplifier

A remote control plug allows
you to operate with the ampli-
fier ON or OFF, or in
SSB/AM, FM or CW
from the dashboard.



The 2002 utilizes the latest state of the art engineering including micro-
strip circuitry and modular construction. The three final transistors
combine to produce 250W when driven by 15W or more at 13.8VDC.

POWER INPUT:
5-20W Carrier FM or CW
20W PEP maximum SSB or AM

HARMONIC ATTENUATION:
All Harmonics Attenuated
60 dB or Greater

POWER OUTPUT:
200-250W carrier FM or CW
300W PEP SSB or AM

CURRENT DRAIN:
FM-40 Amps @ 250W
SSB-30 Amps @ 300W PEP

FREQUENCY RANGE:
144 to 148 MHz*
* will operate with slight
degradation at 142-150 MHz.

DUTY CYCLE:
FM 50% @ 150W 33% @ 250W
SSB 60% @ 150W 50% @ 250W

Model 2002 \$479.00

can be ordered for repeater application
for additional information contact

TPL COMMUNICATIONS INC.

1324 W. 135TH ST., GARDENA, CA 90247 (213) 538-9814

Canada: Lenbrook Industries, Ltd., 1145 Bellamy Rd., Scarborough, Ontario M1H 1H5
Export: EMEC Inc., 2350 South 30th Avenue, Hallandale, Florida 33009



GREGORY ELECTRONICS
The FM Used
Equipment People.

2 METER PORTABLE G.E. MASTR PR36 132-150 MHz — 5 Watts

All Solid State
with Ni-cad Battery
\$228.00



Vehicular Charger 4EP63A

(sold only with unit)\$25.00

A.C. Charger

(subject to availability)\$25.00

Speaker/Mike Type EM36\$15.00



GREGORY ELECTRONICS CORP.

245 Rt. 46, Saddle Brook, N.J. 07662
Phone: (201) 489-9000

GETTING OUR STRONG POINTS OUT IN THE OPEN

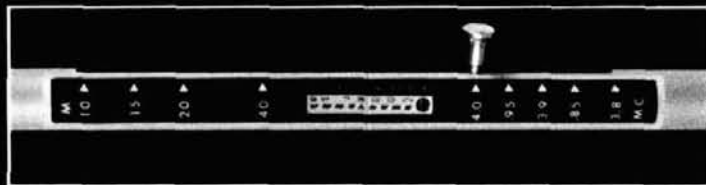
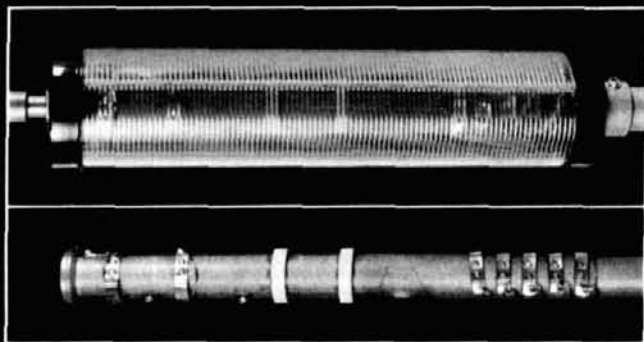
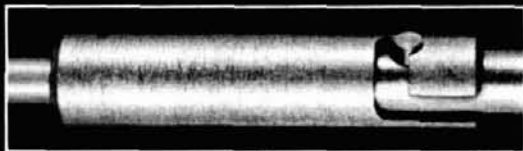

Before you take off for the wide open spaces, close in on the top performer in the field:

Swan's 5-band Mobile 45, loaded with high-engineering specs unavailable from any other antenna source today.

Wait till you see how we've got band-switching in hand. This has got to turn you on!

No more coil changing. At the flick of the positive-stop switch, skip across all 5 bands freely using our High-Q tapped coil. Nine positions to shift to:

one each for 10, 15, 20 and 40 meters

five settings on 75 meters

And gold smooths the way. Only Mobile 45's rods slide through switch contacts that we've *gold-plated*, to deliver a swan-song to corrosion.

All for \$119.95, with 1000 watts PEP, and the same extra rugged, heavy duty construction you always count on from Swan.

Check out Mobile 45's exclusive strong points at your Swan dealer, where—your Swan Credit Card's good anytime.

Please rush full details for the Swan 5-band Mobile 45 with manual band-switching.

Name _____

Address _____

City _____

State _____ Zip _____

FREE! Personalized call-letter plaque

2 1/2" x 4" with stand, no charge

Please send my plaque imprinted with my station call



SWAN
ELECTRONICS
a subsidiary of Cubic Corporation

305 Airport Road, Oceanside, CA 92054

ITS WHAT YOU CAN'T HEAR THAT MAKES YOUR QSO Q5

The Frequency-Agile FL-1 is totally unique in that it will automatically scan the 280-3,000 Hz audio spectrum, and when sensing interfering heterodynes, CW or RTTY signals, rejects them up to 40 DB!

NOTCH-MODE OPERATION

During your SSB/SSTV operations, the Frequency-Agile FL-1 AUTOMATICALLY scans, locks, and tracks interference within the 280-3000 Hz. spectrum, and in a second or two reduces QRM up to 40 db! For CW/RTTY usage, fully INDEPENDENT control of bandwidth

and center frequency provide rejection of interfering signals up to, or greater than 40 db.

PEAK-MODE OPERATION

The SSB/SSTV operator, using the fully INDEPENDENT controls of the FL-1, can precisely tailor the audio response; reducing or eliminating adjacent channel splatter or SSTV QRM. The CW/RTTY operator can adjust bandwidth down to 25 Hz rejecting virtually all interference to the desired signal. Often, the AUTOMATIC and AFC features of the FL-1 are desirable when in this mode.



\$179⁹⁵

including Pre-Paid shipping & full insurance

- Made in England
- Full 1 year warranty
- VISA-MASTERCHARGE accepted

GENERAL SPECIFICATIONS

- Size: 8"W, 3"H, 5.5"D
- Requires 9-16 VDC from either internal battery or external supply (not included)
- Installs easily in your audio line between your receiver and speaker
- Highest quality construction - 2 glass circuit boards, 8 I.C.s, 6 Transistors, 8 Diodes, 2 LEDs.

Dedicated to Excellence

AR Technical Products Corp.

(Exclusive Importers of DATONG FL-1's)

Box 62 Birmingham, Michigan 48010 Telephone 313/588-2288

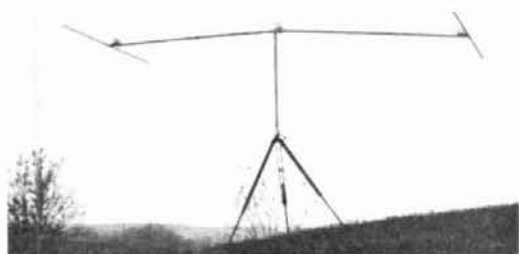

!! JUST IN TIME FOR FIELD-DAY !!

The **HF BANTAM DIPOLE** is a truly portable all-band miniature dipole complete with its own carrying case and mast/hardware to mount on a camera tripod (3/8" x 24 adaptor available). High performance is obtained on 80-10 meters at its normal 13 foot length or the same antenna may be shortened to 7 feet for 75-10 meter coverage. Polarization is quickly interchangeable from horizontal to vertical. No ground system necessary. The **BANTAM DIPOLE** is ideal for camping, traveling, mountain-topping, apartment living, or if you're stuck with building code restrictions. Construction is of high quality 6061-T6 aluminum and stainless steel hardware. 30-day money back guarantee.



\$59⁹⁵

plus U.P.S. shipping

LAUREL PLAZA — RTE. 198
LAUREL, MD 20810
301-792-0600

Send S.A.E. for spec sheet
U.S. patent pending
Dealer inquiries invited

DRAKE • ICOM • TEN-TEC • TEMPO • WILSON

NEW TOUCH-O-MATIC TOUCH TONE ENCODER



ONLY **\$39.95**

AT YOUR LOCAL HAM DEALER



- ★ Digitran positive touch keyboard
- ★ New lower price results from applying latest integrated circuit technology
- ★ Automatic transmitter keying when you dial. Complete with built-in keying and delay circuitry.
- ★ Great for hand-helds and mobiles
- ★ Crystal Stable
- ★ Quality and performance comparable to encoders selling for \$20 to \$30 more.

FOR DEALER INFORMATION WRITE
T/T Communications
1344 N. Scottsdale Road
Tempe, AZ 85281

flea market



RATES Non-commercial ads 10¢ per word; commercial ads 60¢ per word both payable in advance. No cash discounts or agency commissions allowed.

HAMFESTS Sponsored by non-profit organizations receive one free Flea Market ad (subject to our editing). Repeat insertions of hamfest ads pay the non-commercial rate.

COPY No special layout or arrangements available. Material should be typewritten or clearly printed (not all capitals) and must include full name and address. We reserve the right to reject unsuitable copy. **Ham Radio** cannot check each advertiser and thus cannot be held responsible for claims made. Liability for correctness of material limited to corrected ad in next available issue

DEADLINE 15th of second preceding month.

SEND MATERIAL TO: Flea Market, Ham Radio, Greenville, N.H. 03048.

I HAVE A BEAUTIFUL KENWOOD TS-520S transceiver that happens to be surplus to my present needs. It is like new, has all cables, manual, warranty card (not filled in) and is in perfect condition, inside and out. I will include a new MC-50 matching microphone with the rig. I prefer not to ship, but will ship, if you insist, in original factory carton and protective cover. This rig has the **CW filter installed!** You will never regret buying this rig — especially at my rock-bottom price of \$650 plus shipping. First cashier's check or Money Order takes it. W1XU. Tel. (603) 924-6759. Do not call before June 2nd, and no collect calls, please.

HAM RADIO HORIZONS, a super new magazine for the Beginner, the Novice and anyone interested in Amateur Radio... What it's all about, How to get started, The fun of ham radio. It's all here and just \$10.00 per year. **HURRY! HURRY!** Ham Radio HORIZONS, Greenville, NH 03048.

CANADIANS 1,000,000 surplus parts. Bargains galore. Free catalog. Etc-HR, Box 741, Montreal, H3C 2V2.

PORTA PAK the accessory that makes your mobile really portable. \$67.50 and \$88.00. Dealer inquires invited. P.O. Box 67, Somers, Wisc. 53171.

Foreign Subscription Agents for Ham Radio Magazine

Ham Radio Austria
Karin Ueber
Postfach 2454
D-7850 Loerrach
West Germany

Ham Radio Belgium
Stereohouse
Brusselsesteenweg 416
B-9218 Gent
Belgium

Ham Radio Canada
Box 114, Goderich
Ontario, Canada N7A 3Y5

Ham Radio Europe
Box 444
S-194 04 Upplands Vasby
Sweden

Ham Radio France
Christiane Michel
F-89117 Parly
France

Ham Radio Germany
Karin Ueber
Postfach 2454
D-7850 Loerrach
West Germany

Ham Radio Holland
MRL Electronics
Postbus 88
NL-2204 Delft
Holland

Ham Radio Italy
STE, Via Manliago 15
I-20134 Milano
Italy

Ham Radio Switzerland
Karin Ueber
Postfach 2454
D-7850 Loerrach
West Germany

Ham Radio UK
P.O. Box 63, Harrow
Middlesex HA3 6HS,
England

Holland Radio
143 Greenway
Greenside, Johannesburg
Republic of South Africa

MOBILE IGNITION SHIELDING provides more range with no noise. Available most engines. Many other suppression accessories. Literature, Estes Engineering, 930 Marine Dr., Port Angeles, WA 93862.

BUY-SELL-TRADE. Send \$1.00 for catalog. Give name, address and call letters. Complete stock of major brands. New and reconditioned equipment. Call for best deals. We buy Collins, Drake, Swan, etc. SSB & FM. Associated Radio, 8012 Conser, Overland Park, KS 66204. 913-381-5901.

QUAD BUILDERS — Blizzard/Hurricane proof your antenna. Fiberglass vaulting poles. Incredible strength. Guaranteed new, 8- for \$240.00. S.A.S.E. for info. K5WSE, Box 20-AA, San Antonio, Texas 78201. (512) 699-9260.

TELETYPEWRITER PARTS, gears, manuals, supplies, tools, toroids. SASE list. Typetronics, Box 8873, Ft. Lauderdale, FL. 33310. N4TT Buy parts, late machines.

VHF-UHF TRANSVERTERS: Extend frequency range of your HF, VHF gear. Send for info. UHF-VHF COMMUNICATIONS, 53 St. Andrew, Rapid City, SD 57701.

FOR SALE: Pair of 1977 call books; \$6.00: Late issues of QST and Ham Radio \$2.50 per year: plus shipping all items: Hy-Gain 204Ba, with BN86 balun, BMC clamp, \$115.00. Prefer pick up: Clark W3HZ.

CERTIFICATE for proven two-way radio contacts with Amateurs in all ten USA call areas. Award suitable to frame and proven achievements added on request. SASE brings TAD data sheet from W6LS, 2814 Empire, Burbank, CA 91504.

FREE CATALOG of new merchandise. Resistors, capacitors, IC's, semiconductors, and more. Send to: Key Electronics, Box 3506H, Schenectady, New York 12303.

WANTED: Measurements 59 grid dipper. Also interested in HF and UHF tuning heads. Jim Fisk, W1HR, Ham Radio, Greenville, NH 03048.

WANTED: Davco DR230 receiver. Please state price and condition in first letter. Jim Fisk, W1HR, Ham Radio, Greenville, NH 03048.

SEE OUR AD in this issue, Pyramid Data, Page 000.

B&K TEST EQUIPMENT. Free catalog. Free shipping. Dinosaur discounts. Spacetron-CE, 948 Prospect, Elmhurst, IL 60126.

MOTOROLA HT220, HT200, and Pageboy service and modifications performed at reasonable rates. WA4FRV (804) 320-4439, evenings.

AUTHORIZED DEALER for DenTron, KLM, Larsen, Bearcat, etc., Big Catalog 201-962-4895 Narwid Electronics, 61 Bellot Road, Ringwood, N.J. 07456.

RECONDITIONED TEST EQUIPMENT for sale. Catalog \$5.00. Walter, 2697 Nickel, San Pablo, Ca. 94806.

TELETYPEWRITER PARTS WANTED: for all machines manufactured by: Klienschmidt Corp., Teletype Corp. and Mite. Any quantity, top prices paid send list for my quote. Phil Rickson, W4LNW, Rt. 6, Box 1103G2, Brooksville, FL 33512.

VERY in-ter-est-ing! Next 4 issues \$1. "The Ham Trader", 2435 Fruitville, Sycamore, IL 60178.

QSL CARDS 500/\$10. 400 illustrations, sample. Bowman Printing, Dept. HR, 743 Harvard, St. Louis, MO 63130.

HOME BREWERS: Stamp brings component list. CPO Surplus, Box 189, Braintree, Mass. 02184.

CHANNEL ELEMENTS NEEDED KXN1024A, Motorola for Micor Radio. Need several. WA6COA, 4 Ajax, Berkeley, CA. 94708. (415) 843-5253.

ATLAS 210X \$580, 220 CS \$95, 10X \$30, DMK \$25. All new, unused, in original cartons. Package deal \$700. Have two of each. Reid W6MTF, 2701 Durant #9, Berkeley, CA 94704. 415-549-0518.

ORP ACCU-KEYER PC board, G-10 drilled. See QST Jan. 76; \$5.00. I/O Engineering, 9503 Gambels Quail, Austin, Texas. 78758. K5PA.

TELETYPES, Models 15-35 \$75-up. SASE for list. Goodman, 5454 South Shore, Chicago, IL 60615.

RTTY — NS-1A PLL demodulator. Board \$3.50; Parts \$15.00; W/T \$24.95, all postpaid. SASE for info. Nat Stinnette Electronics, Tavares, FL 32778.

NEED — IC-22S or better 2M Synthesized Transceiver, Atlas 180/210/215, R.F. Signal Generator. TRADE (or sell) TV camera with zoom lens — \$179 for VTR. SSTV/ATV, Security uses. Data Precision #245 DMM (4* digits) with nicads, manuals. W6DOM, 6017 Majorca Ct., San Jose, California 95120. (408) 997-0132.

SUPER-BUY — 5000 mfd. @ 40 volt electrolytic cap. factory new and complete w/all hardware. \$1.35 ea. ppd.

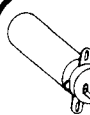

Plug-in transformer. Secondary is 7 Vac 300 mA. A very good deal for TTL-CMOS circuits. \$2.00 ppd.



Push-on Pull-off panel mount switch. High quality Grayhill switch complete with hardware. 25c ea. ppd.

High-gain 8 watt audio amp. 20 mV will drive it to 8 watts out. Rectifiers and filter cap on the board. Size approx. 3" x 4" x 3" high. All you need is 24-0-24 volts ac. Of course we supply schematic. \$3.25 ppd.

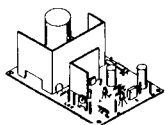

SMOKE DETECTOR



Protect your family — home — and business. These U.L. Approved, ALL METAL units were removed from large apartment complex being torn down. 115 Volt AC input. Sensitivity to smoke is 2% per ft. max. Paint may be scratched but all units tested before shipment. Buy now — Don't delay longer. \$8.95 ea. ppd.

Transformer: 115V AC Primary 12 volt 200 mA Secondary. PC Board type — A very handy unit \$1.00 ppd.

— PL55 patch cord — a full 20 feet long with a molded PL55 one end. Real nice. A low — 75c ea. ppd.

4PDT Relay, 12VDC coil, Potter Brumfield, 5 amp contacts, factory new of course, a beauty \$1.90 ea.



Mini-Toggle. DPDT Cutler-Hammer wire-wrap terminals but can also be soldered. Gold plated. A very high quality unit. Hardware supplied. \$1.50 ea. ppd.

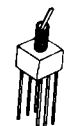

Computer Grade Capacitor. 5100 mfd @ 50 volts. Size: 2" dia. x 2-1/4" high. \$1.90 ea. ppd.

MA1003 Clock Module \$18.95

1000 volt PIV 2 amp diodes .10 ea.

ALL ITEMS PPD USA
SEND STAMP FOR LIST OF BARGAINS
PA RESIDENTS ADD 6% SALES TAX
FONE 412-863-7006



Full Electronics

12690 ROUTE 30
NORTH HUNTINGDON, PA. 15642

COAXIAL SWITCHES



Model 376
\$18.95

Model 375
\$18.95

Model 550A
\$14.00

Model 595
\$18.50

Model 592
\$16.50

Model 377 \$17.95

Others available:

Model	Outputs	Connector	Price
550A-2	2	Radial	\$12.50
551A	2	Radial	\$17.50
590	5	Axial	\$17.95
590G	5	Axial	\$17.95
556	Bracket, wall mount		\$.95

Prices subject to change without notice

NOW IN STOCK □ Transmitting Variables □ Roller Inductors □ Counter Dials □ Air Wound Coils □ Couplings □ Knobs □ Receiving Variables □ Toroids □ R.F. Chokes □ Coil Forms □ And much more from names like • Millen • E.F. Johnson • Barker & Williamson • J.W. Miller • Hammarlund

For RUSH ORDERS Call
(603) 673-6290

Add \$2.00 per order to cover shipping & handling charges

SEND FOR PARTS CATALOG
With First Class Stamp

G.R. WHITEHOUSE & CO.
10 Newbury Drive Amherst N.H. 03031

flea market

WANTED: AN/PRC-70, 74 and/or parts and accessories. Send details and price. T. Stroh 6301 Glade Ave., K220 Woodland Hills, CA 91367.

SELL or trade for VHF rig: novice rigs, surplus gear, tele-type parts, tubes, components. SASE for my list. K00P Mike Reed, Rt. 1, Box 200, Wolbach, Nebraska 68882.

WANTED HAM RADIO back issues: May, July, Oct., Dec. of 1968; Jan., Oct. of 1969; March of 1970. Have many to sell. \$.25 each, plus postage. SASE for list. K1MJT/4, Rt. 2, Box 50A-1, Scottsville, VA 24590.

SELL: Tubes, current and rare. Xmtting and receiving. Meters, xtals, HV capacitors. Power, I-F transformers. Antiques. Government, military surplus. 40 year accumulation. SASE for list. Grigas, 10137 Prospect, Chicago, IL 60643.

ICOM IC-245 Sell like new with ssb adapter. A super deal at \$450. WB9LSW Angelo, 1875 W. Sheridan, Milwaukee, WI 53209 (414) 228-8719 evenings.

SELL: Parts for transmitters, linears. Capacitors (vacuum, filter, air), meters, equipment, all PREPAID. Large SASE for list. Paul Amis, W7RGL, 8730 Ferncliff Ave., Bainbridge Island, WA 98110.

HEATHKIT COMPUTER SYSTEMS expertly built. Inquire about other brands, etc. Write: WA2BSR, 2790 West 5th St., Brooklyn, NY 11224.

COMMUNICATIONS ENGINEERS — SENIOR TECHNICIANS: 25-36K after six month apprenticeship. We have openings for highly competent self motivated professionals with in depth knowledge of analog and digital circuits and proven "hands on" troubleshooting ability. You will have full responsibility for maintenance of complex shipboard communications, electronics navigation, and computer systems and be required to handle all ships communications. A second class FCC radio-telegraph license is required. If you lack the FCC license but are otherwise qualified we can train you. Outstanding vacation and fringe benefits. Submit resume in confidence to: Radio Officers Union, ATTN: IME, 70 Hudson Street, Room 710, Hoboken, New Jersey 07030 or telephone 201-659-7370.

ANTENNA: All ham bands (80 thru 10) \$25 postpaid U.S.A. (CA residents add \$1.50 sales tax) Rudy Plak, P.O. Box 966, San Marcos, CA 92069.

QUAGI/YAGI BUILDERS — Insulated fiberglass booms to 16-feet. Straight, strong, vaulting poles. S.A.S.E. for info. Guaranteed new \$30.00 K5WSE, Box 20-AA, San Antonio, Texas 78201. (512) 699-9260.

TELETYPE EQUIPMENT for beginners and experienced operators. RTTY machines, parts, supplies. Beginner's special: Model 15 Printer and demodulator \$139.00. Dozen black ribbons \$6.50; case 40 rolls 11/16 perf. tape \$17.50 FOB. Atlantic Surplus Sales, 3730 Nautilus Ave., Brooklyn, N. Y. 11224. Tel: (212) 372-0349.

FAST PROFESSIONAL HAM REPAIR Service. New York City area. Amateur extra; FCC Commercial License. Fully equipped shop. Reasonable. Rich Tashner N2EO. 212-352-1214.

FOR SALE: FT-101E with FA-9 and SP-101B. Newest model with latest processor and blanker. Mint. Must sell for financial reasons. Pick up only \$700.00. (212) 591-5796

SB-313 SOLID STATE RCVR. 80-15M & SW broadcast. A-m, ssb, & CW xtal filters. \$225 plus shipping. WD4GRI, 1907 Lodgepole, No. Augusta, SC 29841.

CLEANING OUT SHACK: Scopes, Xmters, Recvrs. Generators, Counters, Antennas, Tubes, Racks, Meters, etc. 15 yr. collection, price right, SASE for list. WA8GFR 3358 West 130th, Cleve, Ohio 44111.

THE "CADILLAC" of QSL's! Samples: \$1.00 (Refundable) — W5YI, Box #1171-D; Garland, Texas 75040.

EXCLUSIVELY HAM TELETYPE 24th year, RTTY Journal, articles, news, DX, VHF, classified ads. Sample 35¢. \$3.50 per year. 1155 Arden Drive, Encinitas, Calif. 92024.

FIGHT TVI with the RSO Low Pass Filter. For brochure write: Taylor Communications Manufacturing Company, Box 126, Agincourt, Ontario, Canada MIS 3B4.

MANUALS for most ham gear made 1937/1970. Send only 25¢ coin for list of manuals, postpaid. HI, Inc., Box H864, Council Bluffs, Iowa 51501.

TECHNICAL MANUALS — send 50¢ stamps for 30 page list. Jim Cooper, W2JC, Box 73, Paramus, NJ 07652.

EEB STOCKS



All Models & elements



- We pay AIR FREIGHT on all prepaid or credit card orders.
- Call our order desk collect: 703-938-3511.
- We stock in depth: Bird 43 Thru-line, All Table 1 elements, CC-1 & EC-1 cases.

MODEL 43 \$120.00

AUTHORIZED BIRD DISTRIBUTOR
DEALER INQUIRIES INVITED.

ICOM IN STOCK

- IC-245/SSB \$599
- IC-211 \$749
- IC-701 Write

plus others

Wilson IN STOCK

- WE-800
- MARK II HANDHELD
- MARK IV HANDHELD

and much, much more

All Prepaid & Charge Orders
Shipped NO CHARGE in U.S.
Sales tax 4% to Virginia residents only.

ELECTRONIC EQUIPMENT BANK, INC.
516H Mill St., Vienna, VA 22180
703-938-3511

BUILD-IT-YOURSELF AVIONICS FOR HAM PILOTS

Free catalogue describes high technology, low cost avionics and test equipment offered in kit form. Product line includes audio panel, aircraft band two-channel transceiver, digital chronometer, navigation and communications test equipment, bench power supply, and more. Shoot us the coupon for details.

Name _____
Address _____
City _____ State _____ Zip _____

(916) 272-2203
Radio Systems Technology, Inc.
RR 5, GRASS VALLEY, CA 95945

SUB-AUDIBLE GENERATOR for FM

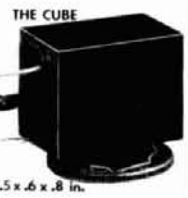

- Inexpensive multi tone encoder
- Compatible with PL-CG-QC
- Low distortion sinewave
- Input 8-18 VDC unregulated
- Rugged, plastic encased with leads
- Adjustable frequency (98-250 Hz), Lower available
- Excellent stability

Price \$19.95

Freq. set at factory \$5.00 extra

Calif. res. add 6%

Send for more info
yle products
Dept. In P.O. Box 2083 Santa Clara, CA 95051

DSI

DSI INSTRUMENTS INC.

Be the one who's on FREQUENCY!!

With your *DSI Counter*. . . save the shop cost of tweaking xtals. . . know your frequency. . . from 160 meters through 450 MHz. Now *DSI* offers *the most* counter for your dollar. Latest state-of-the-art technology. . . *DSI* advanced LSI design far exceeds outdated TTL. Go with the leader . . . buy a *DSI FREQUENCY* counter and **SAVE TIME & MONEY!!**



MODEL 3500 \$139.95
Includes TCXO ± 1 PPM



MODEL 3600A \$189.95
Includes oven timebase $\pm .5$ PPM

- **MADE IN USA**—Factory assembled—2 Hr. Burn-in Test & Calibration
- Built in 600MHz Prescaler with RF Preamp—Not an add-on
- 7 Large Bright— $\frac{1}{2}$ inch LED Readouts
- Resolution—10Hz Non-Prescaled 100Hz Prescaled, .1 sec Gate
- **ACCURACY** ± 1 PPM \pm one count ± 1 PPM per six months from 65°F to 85°F
- **SENSITIVITY**—50 mVrms 150 to 250MHz 100mV @ 450MHz
- Gate Time Light—Automatic Decimal Point Placement
- Automatic Leading Zero Blanking When No Input Signal is Present
- No RF Connection Required with Supplied Antenna
- **S0239** Connectors Supplied for Direct Probe Input
- AC or DC Operation—115 VAC 50/60 Hz 8.5V to 13.5VDC @ 300ma
- Comprehensive **Owners Manual** with Complete Schematics
- Size 2 7/8" H x 8" W x 5" Deep

- **MADE IN USA**—Factory Assembled—8 Hr. Burn-in Test & Calibration
- Built in 600MHz Prescaler & RF Preamp—Not an add-on
- 8 Large Bright— $\frac{1}{2}$ inch LED Readouts
- Two Selectable Gate Times—.1 sec. & .1 sec. 100Hz to 600MHz
- **Accuracy** $\pm .5$ PPM \pm one count ± 1 PPM per six months from 50°F to 100°F
- **Sensitivity**—10mVrms 150 to 250MHz 50mV @ 450MHz
- Gate-time & Oven Light—Automatic Decimal Point Placement
- Automatic Leading Zero Blanking—When No Input Signal is present
- No Direct RF Connection Required—With Supplied Antenna
- **S0239** Hz Input 50Hz to 75MHz—**S0239** Low ± 10 MHz to 600MHz
- AC or DC Operation 115 VAC 50/60 Hz, 8.5V to 13.5VDC @ 400ma
- 50Hz to 600MHz Sine or Square Wave Input
- **FCC Certifiable**—Designed for the Professional Service Technician
- Resolution 1 Hz Non-Prescaled 10Hz Prescaled @ .1 sec. Gate

PERFORMANCE YOU CAN COUNT ON

1. **PPM OVER TEMPERATURE RANGE** With a spec. of ± 1 PPM over 50°F to 100°F, your worst error over temperature would be ± 145 Hz, when measuring 145 MHz. This is the most important specification for any frequency counter because temperature variation of only a few degrees could have a drastic effect on the accuracy of your counter.
2. **PPM LONG TERM** With a spec. of ± 1 PPM per six months, your additional error would only be 145Hz when measuring 145MHz, six months after calibration.
3. **LAST DIGIT ERROR** All counters have an error in the last digit, if the last digit should read a 5 it could be a 4, 5 or 6. When you have 10 Hz resolution (last digit represents tens of Hz) your additional error will be ± 10 Hz.
4. **TOTAL ERROR** The overall error of a counter is the sum of the error due to temperature variation, last digit error and long term error. A simple ± 1 PPM spec. with no mention of temperature or ageing could conceal a much larger overall inaccuracy. Example: ± 1 PPM at 75°F is ± 145 Hz at 145MHz, but the same counter might be in error 1 KHz or more at only 85°F.

VISIT US AT YOUR NEXT HAMVENTION

Dayton, Ohio 28, 29, 30 April • Baton Rouge, LA 5, 6, 7 May • Birmingham, ALA 13, 14 May • L.E.R.C., L.A., CA 20, 21 May

See Your Local Dealer

or

Call Toll Free (800) 854-2049 *DSI Instruments Inc.*

• NO EXTRA COSTS •

FREE Shipping anywhere in U.S.A.

Name _____

Address _____

City _____ State _____ Zip Code _____

Please send more information on your full line of instruments

Check Enclosed C.O.D.

Please charge my: Bank Americard Visa Master Charge AE

Card # _____ Exp. Date _____

Signature _____

.....
: Strongest warranty in the counter field. :
: **ONE YEAR** Parts and Labor :
: Satisfaction Guaranteed. :
:.....

Dennis Romack WA60Y1
VP Marketing, DSI

California Residents add 6% State Sales Tax and Call Collect (714) 565-8402

7914 Ronson Road No. G, San Diego, CA 92111

More Details? CHECK—OFF Page 142

june 1978 **HP** 119

CHICAGO

Area Amateurs

Know

ERICKSON

Can Provide
All Their
Amateur Radio
needs!

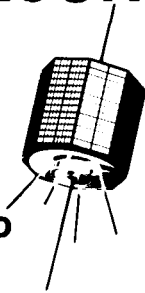

**WB9JKT, WB9ZRA
and WN9ANF
serving you with...**

- Ameco • ASP • Atlas
- Belden • Bird • CDE • CIR
- CES • Collins • Cushcraft
- Dentron • Drake • HAL
- Hy-Gain • Icom • KLM
- Kenwood • Larsen • MFJ
- Midland • Mosley • NPC
- Newtronics • Nye
- Regency • Shure • Swan
- Standard • TPL • Tempo
- Ten-Tec • Wilson • Yaesu



Hours: 9:30-5:30 Mon., Tues., Wed. & Fri.
9:30-9:00 Thurs.
9:00-3:00 Sat.



**ERICKSON
COMMUNICATIONS**
5935 N. Milwaukee Ave.
Chicago, IL 60646
(312) 631-5181

flea market

TECH MANUALS for Govt. surplus gear — \$6.50 each: SP-600JX, URM-25D, OS-8A/U, TS-173/UR. Thousands more available. Send 50¢ (coin) for 22-page list. W3IHD, 7218 Roanne Drive, Washington, DC 20021.

QSL FORWARDING SERVICE — 30 cards per dollar. Write: QSL Express, 30 Lockwood Lane, West Chester, PA. 19380.

RECEIVE PARTS LISTS regularly for \$4/yr. Surplus Parts, P.O. Box 7057, Norfolk, VA 23509.

WANT UP-TO-DATE INFORMATION? Radio-Hobbyist Newsletter issued every 2 weeks. Only \$5.00 year. W5YI, Box 1171-D, Garland, Texas 75040.

EZ deals are the best! Try me and see for Yaesu, Drake, KLM, Swan, Cushcraft, DenTron, VHF Eng, ICOM, CDE, Hustler, Wilson and more. Call, see or write W0EZ, Bob Smith Electronics, RFD 3, Hwy 169 & 7, Fort Dodge, IA 50501. (515) 576-3886.

TRAVEL-PAK QSL KIT — Send call and 25¢; receive your call sample kit in return. Samco, Box 203, Wynantskill, NY 12198.

THE MEASUREMENT SHOP has used/reconditioned test equipment at sensible prices; catalog. 2 West 22nd St., Baltimore, MD 21218.

RADIO MUSEUM NOW OPEN. Free admission, 15,000 pieces of equipment from 1850 telegraph instruments to amateur and commercial transmitters of the 1920s. Amateur station W2AN. Write for information: Antique Wireless Assn., Main St., Holcomb, NY 14469.

AMATEUR MICROPROCESSOR EXPERIMENTERS: 10 MHz ± 20 ppm Coldweld crystals. 1 ppm/yr. 32 pF. C₀ 6 pF. \$4.25 ea. postpaid. Savoy Electronics, Inc., P.O. Box 5727, Ft. Lauderdale, FL 33310. 305-563-1333.

WE BUY ELECTRON TUBES, diodes, transistors, integrated circuits, semiconductors. ASTRAL ELECTRONICS, 321 Pennsylvania Avenue, Linden, NJ 07036. 201-486-3300.

AUTHORIZED DISTRIBUTOR F9FT Antennas, Microwave Modules, RIW Products' new tandem reflector, 19 element, 432 MHz Yagi — Radio Clinic — N2MB (formerly WA2BIT) 212-327-4952.

STOP LOOKING for a good deal on amateur radio equipment — you've found it here — at your amateur radio headquarters in the heart of the Midwest. We are factory-authorized dealers for Yaesu, Kenwood, Drake, Collins, ICOM, Ten-Tec, Atlas, Hallicrafters, Wilson, Regency, Tempo, Swan, Midland, Alpha, Standard, DenTron, Hy-Gain, Mosley, Cushcraft, and CDE, plus accessories. Thousands of thrifty hams from coast to coast already know us and we invite you to join them by writing or calling us today for our low quote and trying our personal and friendly Hoosier service. HOOSIER ELECTRONICS, P.O. Box 2001, Terre Haute, Indiana 47802. 812-238-1456.

AUDIO SPEECH PROCESSOR — details "Ham Radio", Aug. '77, page 48. Board only \$5.60 ppd. Board and components, you add case and switch, \$17.95 ppd. Getz Engineering, 685 Farnum Rd., Media, PA 19063.

NEW NORTH ELECTRIC COMPUTER POWER supplies, adjustable positive 12, negative 12 volts, 10 amps each, Positive 5 volts 15 amps, ripple .0015 typical, 105-132 volts common buss, punched metal cover. 78 lbs. FOB \$114.75. Browns Electronics, RFD 2, Platte City, MO 64079.

SCANADAPTER — scan up to 10 channels of any receiver/transceiver, variable scan rate, manual advance, and 7 segment readout. Only \$29.95 wired. Pulse generators, high gain Instrument amps, more. Free literature. Tek Devices, Box 19154, Honolulu, HI 96817.

HAM RADIO HORIZONS, a super new magazine for the Beginner, the Novice and anyone interested in Amateur Radio... What it's all about, How to get started, The fun of ham radio. It's all here and just \$10.00 per year. HURRY! HURRY! Ham Radio HORIZONS, Greenville, NH 03048.

Coming Events

MARYLAND: Frederick ARC 1st annual Hamfest Sunday, June 18, Frederick Fair Grounds, East Patrick St., Frederick. Grounds open 6 AM for commercial displays, general admission 8 AM. Talk-in 146.52, 137.3. Prizes, exhibits. Write: Mike Staley, 2 W. Main St., New Market, MD 21774.

Regency Scanner

BRINGS
YOU THE
NEWS
WHILE ITS
HAPPENING



10 channels covering
all 5 bands. AC/DC operation.

SAVE \$40 **\$89.95**
LIST-\$129.95

1,000's OF CRYSTALS
•H25C Case Scanner Monitor
•10.7 Amateur Ham
•2 Meter, CB, Standard

1 to 9 **\$3.70** 10 to 49 **\$3.00** 50 and UP **\$2.50**

CRYSTAL BANKING SERVICE
P.O. BOX 683
LYNNFIELD, MASS. 01940

DON'T KEEP A GOOD ANTENNA DOWN

...put it up instead. Install the World-Record Breaking antenna that won W6TYP the QRP ARC 1,000,000 miles/watt award.

THE JOYSTICK VFA

(Variable freq. ant) gives low angle, omni-directional, harmonic free radiation on all bands 160 thru 10 (+MARS and receive on all BC & SW).

1000's of glowing reports in our files of the VFA in use, often in poor QTH and/or under QRP, contests, etc..

SYSTEM 'A' \$84.00

250W P.E.P. &/or Receiving only

SYSTEM 'J' \$110.00

500W P.E.P. &/or Improved Q Factor Receive

Air mail cost included (Each system 3 sections easily assembled to make unit 7' 6" long. Matching ATU). Not only will you save space but you get better value per \$ if buying direct UK manu! Rush your order — Mastercharge, Visa, Americard, or check, or ask for brochure—

PARTRIDGE (HR)

ELECTRONICS LTD

Broadstairs, Kent, England

Tel: 0843 62535

G3CED

G3VFA



TEXAS TOWERS is a wholesaler/distributor of antenna systems for amateurs, and we ship warehouse-direct to hams and clubs all over the U. S. We feature Consolidated Manufacturing

HD-16 heavy-duty towers stackable to 200' with guys or self-supporting to 50' with a house bracket, and interchangeable with Rohn 25G. The HD-16 represents today's best buy in amateur communications towers, and — to prove it — we will ship a 60' HD-16 complete with top section and short base section to your door for only \$215 plus motor freight! Our heavy-duty guy kit is only \$39.50, and we have a complete selection of other accessories to meet your needs. We have crank-up/lift-over masts that require only one set of guys to support VHF-UHF and OSCAR-type antennas — and the guys can be used as HF inverted vees! The price is \$69.50 for a 40', and \$79.50 for a 50', plus freight. We offer brand-new CDE rotors, shipped postpaid in the continental U. S.: BT-1 (programmable) @ \$78; CD-44 @ \$101; Ham III @ \$118; and Tail Twister @ \$212. Clubs and groups: write for quotes on tower-shipments. Orders of \$1500 net, or more, are shipped freight prepaid to most states east of the Rockies. To place an order, or request information, write or call TODAY! BA/VISA or MC accepted.

Write TEXAS TOWERS
Gerald Williamson, K5GW
113 Starlite Drive
Piano, TX 75074 or call
214-423-2376 nites/weekends

THINKING ABOUT OSCAR?

Here are some helpful suggestions -

AT LAST! A 2 METER SSB TRANSVERTER

At a price you can afford

Use inexpensive recycled 10 or 11 meter ssb exciter on 2 meters.

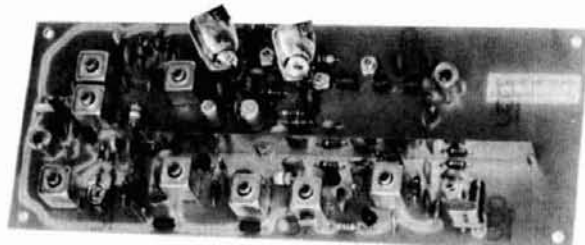

FEATURES:

- Linear Converter for SSB, CW, FM, etc.
- A fraction of the price of other units
- 2W p.e.p. output with 5 MW of drive
- Use low power tap on exciter or attenuator pad
- Easy to align with built-in test points

Frequency Schemes Available:

VX2-4	28-30 = 144-146	□	Other frequency
VX2-5	28-29 = 145-146	□	ranges available
VX2-6	26-28 = 144-146	□	on special order

2M LINEAR POWER AMPLIFIERS:

LPA 2-15 Kit	15 W p.e.p.	\$69.95
LPA 2-70 Kit	70 W p.e.p.	\$139.95

VX2-() TRANSVERTER KIT \$59.95
A25 Optional Cabinet for Xverter & PA \$20

FAMOUS HAMTRONICS PREAMPS

let you hear the weak ones!

Great for OSCAR, SSB, FM, ATV. Over 10,000 in use throughout the world on all types of receivers.

P9 Kit \$12.95

P14 Wired \$24.95

Deluxe vhf model for applications where space permits.

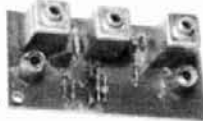

- 1-1/2 x 3" • Covers any 4 MHz band • 12 Vdc
- Ideal for OSCAR • Diode protection • 20dB gain

MODEL	RANGE
P9-LO	26-88 MHz
P9-HI	88-172 MHz
P9-220	172-230 MHz
P14 Wired	Give exact band



P8 Kit \$10.95

P16 Wired \$21.95

- Covers any 4 MHz band
 - 20 dB gain • 12 Vdc
- Miniature VHF model for tight spaces - size only 1/2 x 2-3/8 inches.

MODEL	RANGE
P8-LO	20-83 MHz
P8-HI	83-190 MHz
P8-220	220-230 MHz
P16 Wired	Give exact band

P15 Kit \$18.95

P35 Wired \$34.95

- Covers any 6 MHz band in UHF range of 380-520 MHz
- 20 dB gain • Low noise



FM/CW TRANSMITTER KITS

BUILD UP YOUR OWN GEAR FOR OSCAR CW OPERATION, FM REPEATERS, CONTROL LINKS

- Professional Sounding Audio • Free of Spurs
- Completely Stable • Built-in Testing Aids



T40 11 Channel 200 MW Exciter Kit for 2M or 6M band..... \$39.95

T20 Tripler/Driver Kit. Use with T40 for operation on 432-450 MHz band..... \$19.95



T80 RF POWER AMPLIFIER MODULES FOR ABOVE

- No tuning • VSWR Protected • Wired and Tested
- Rated for Continuous Duty - Great for Repeaters

T80-150: 140-175 MHz, 20-25W output \$79.95
 T80-450: 430-470 MHz, 13-15W output \$79.95

New VHF&UHF Converter Kits

let you receive OSCAR signals and other exciting SSB, CW, & FM activity on your present HF receiver.



either one
- ONLY \$34.95
 including crystal



MODEL	RF RANGE (MHZ)	I-F RANGE
C50	50-52	28-30
C144	144-146	28-30
C145	145-147 (OSCAR)	28-30
C146	146-148	28-30
C110	Aircraft	28-30
C220	220 band	28-30
Special	Other i-f & rf ranges available	

MODEL	RF RANGE (MHZ)	I-F RANGE
C432-2	432-434	28-30
C432-5	435-437 (OSCAR)	28-30
C432-7	427.25	61.25
C432-9	439.25	61.25
Special	Other i-f & rf ranges available	

A9 Extruded Alum Case/Connectors \$12.95

VHF/UHF FM RCVR KITS

- ★ NEW GENERATION RECEIVERS
- ★ MORE SENSITIVE ★ MORE SELECTIVE (70 or 100 dB)
- ★ COMMERCIAL GRADE DESIGN
- ★ EASY TO ALIGN WITH BUILT-IN TEST CKTS
- ★ LOWER OVERALL COST THAN EVER BEFORE



R70 6-channel VHF Receiver Kit for 2M, 6M, 10M, 220 MHz, or com'l bands..... \$69.95
 Optional xtal filter for 100 dB adj chan 10.00



R90 UHF Receiver Kit for any 2 MHz segment of 380-520 MHz band..... \$89.95

* FREE 1978 CATALOG *

40 PAGE CATALOG IS YOURS FOR THE ASKING!

IT'S EASY TO ORDER!

☎ CALL OR WRITE NOW FOR FREE CATALOG OR TO PLACE ORDER!

☎ PHONE 716-663-9254. (Answering service evenings and weekends for your convenience. Personal service 9-5 eastern time.)

☎ Use credit card, c.o.d., check, m.o.

☎ Add \$2.00 shipping & handling.

IN CANADA, send to Comtec; 5605 Westluxe Ave; Montreal, Que H4W 2N3 or phone 514-482-2640. Add 28% to cover duty, tax, and exchange rate.

hamtronics, inc.

182-C Belmont Rd; Rochester, NY 14612

STEREO CW FILTER



Now an audio filter that really works. Connect to your receiver phone jack, plug your phones into the filter and hear the difference a stable 8-pole active filter can make. Does not ring or sound "tinny". Multiple low Q filters add up to sharp skirt selectivity without ringing.

Switch position 1 gives "wide band" filtering (300 Hz bandwidth, wide skirts). Removes hum and splatter, peaks the signal, but lets off-frequency signals come through.

Switch position 2 gives "narrow-band" filtering (80 Hz bandwidth, steep skirts). Selects the signal you want, eliminates the rest. Greatly improves reception in heavy QRM.

Switch position SS (Simulated-Stereo) puts the narrow band filter to one earphone, the wide band filter to the other. The signal is in both 'phones — the QRM in only one. By the almost magical action of the ears and the brain, the interference is rejected. Yet off-frequency calls can be heard. Great for contest operators, cw nets.

Send for free brochure.

Order direct. \$39.95 in U.S. and Canada. Add \$2.00 shipping/handling. California residents add sales tax.

**PALOMAR
ENGINEERS**
BOX 455, ESCONDIDO, CA 92025
Phone: (714) 747-3343

flea market

NEW YORK: Long Island Mobile ARC Hamfest, Sunday, June 4, Islip Speedway. 9:30 AM to 4:00 PM. Admission \$1.50. Ladies and children 12 and under free. Sellers and exhibitors spaces \$3.00. Talk-in 146.25/85 and 146.52. Route 111, one block south of exit 43 of Southern State Parkway. Write: Hank Wener, WB2ALW, 53 Sherrard St., East Hills, NY 11577. Call 212-355-0606.

AMATEUR COMPUTING 78, WASHINGTON, DC, July 22-23. Sheraton National Hotel, Arlington, VA. To preregister send check for \$4 payable to AMRAD, PO Box 682, McLean, VA 22101.

MICHIGAN: Fourth annual Midland Hamfest sponsored by Central Michigan Amateur Repeater Assoc. June 3, Midland County Fairgrounds. Admission: \$1.50 advance, \$2.00 door, under 12 free. Talk-in 07-67 Midland, 13-73 Pleasant Valley. Portables on 52. Demonstrations, Door Prizes, Auction. Tables available \$2.00. Take I-75 N to US 10 West to Eastman Rd. exit. Send SASE with check to D. Zahm, WB8SDJ, 3871 Monroe, Rt. 8, Midland, MI 48640. Commercial exhibits advance reservation. Write: J. Gunsher, WB8JDW, 4307 Bluebird Dr., Midland, MI 48640.

SANDUSKY COUNTY HAMFEST — Fleamarket June 11, 1978 — Held at Sandusky County Fairgrounds Free-mont, Ohio. Free tables, good food, talk-in 31/91 — 52/52 simplex. Donation \$1.00 at the gate. Further info contact Ken KuKay WB8NVF.

KANSAS: Ham Butchers Net Picnic, June 18, Kelley Park, Burlington. On Highway 75. Covered dish lunch. Prize drawing, flea market. Talk-in 146.52 or 3.963 MHz.

NEW YORK CITY — 2 fleamarkets bigger and better than ever. Indoor-Outdoor, Rain-Shine Sunday, June 18, and Sept. 10; 9 AM to 4 PM. The Municipal Parking Lot 80-25 126th St., Queens, N.Y. One block off Queens Blvd. Free Parking for 1000 cars. Raffle, Refreshments, Fun. Sellers \$2.00; Buyers \$1.00. Talk-in: .52/52; 40/00; Info: (212) 699-9400 days. Sponsored by Hall of Science Amateur Radio Club WB2TBC.

KENTUCKY: JEFFERSON DAVIS MONUMENT AWARD sponsored by the Pennyroyal A.R.S., Hopkinsville, Kentucky, in memory of Jefferson Davis, President of the Confederacy, who was born in Fairview Kentucky. The Pennyroyal A.R.S. will be operating from Jefferson Davis Memorial Park June 3rd, and this certified sequential award will be presented to any amateur who presents written confirmation of contact with any PARS member during the QSO period; or any ten Kentucky amateurs during the year. QSO Party begins 1400 UTC June 3rd and ends 0500 UTC June 4th. Frequencies are: 3.740, 21.140, 28.140 for Novice; and 3.970, 7.270, 14.310, 21.370, and 28.610 for General and higher licenses.

THE SIXTH DISTRICT DX-QSL Bureau is for receiving IN-COMING DX-QSLs for Sixth District Amateur Radio Operators. Send a minimum of 5, (12 Maximum) self-addressed stamped 5-1/2" x 7" envelopes. Place stamp upper right corner and write call only in upper left corner. If more than 5-6 QSLs per month, clip extra 11¢ stamps to one of the envelopes. If reply desired, enclose a regular size SASE. The Bureau can supply envelopes and postage for a donation of \$1.00. Amateurs should send 5 labels with CALL, name and address to Bureau.

SOUTH DAKOTA: ANNUAL HAMFEST, sponsored by Black Hills A.R.C. July 1-2, Surbeck Center, South Dakota School of Mines and Technology, Rapid City. Technical Forums, ARRL Forum, Flea Market, Industrial Tours. Grand Prize, Preregistration Prize and many more. Admission: \$4.50 advance (before June 1), \$5.00 at door. For information write: Black Hills ARC, Box 1014, Rapid City, SD 57709.

MINNESOTA: AMATEUR FAIR '78, Swapfest & Exposition, Saturday, June 3, 9:00 AM to 6:00 PM, Minnesota State Fairgrounds. Admission: \$2.00 Under 12 free. General admission ticket required to sell. Non-commercial car selling and inside tables no extra charge. Indoor commercial space \$10.00/table. ADVANCE RESERVATIONS REQUIRED. Call (612) 933-2823. Major prizes. FM forum, Microprocessor Forum, ARRL Forum, FCC Q&A Session. Talk-in on 16/76, 52/52.

PENNSYLVANIA: MARC HAMFEST, White Deer Township, Firemen Grounds, Allenwood, PA. 8:00 AM to 5:00 PM, Sunday, June 4. \$2.50 advance registration for sellers and tailgaters. \$3.00 gate, XYL and children free. Auction swapping, surplus and commercial electronic equipment. Cash door prizes. Dozens of prizes. Parking for Flea Market. Bring your own table. Snack Bar. QSL and Frequency Guessing Contests. Indoor and outdoors. Talk-in Frequencies 3940 kHz, 2 meter FM, 146.34/94, 37/97, 52/52. For information: Jerry Williamson, WA3SXQ, 10 Old Farm Ln., Milton, PA 17847. 717-742-3027.

THIS IS IT



MODEL 4431 THRULINE®

RF DIRECTIONAL WATTMETER
with VARIABLE RF
SIGNAL SAMPLER — BUILT IN

AUTHORIZED **BIRD** DISTRIBUTOR

Webster
associates

115 BELLARMINE
ROCHESTER, MI 48063

CALL TOLL FREE

800 — 521-2333

IN MICHIGAN 313 — 375 0420

RADIO WORLD

CENTRAL NEW YORK'S FASTEST
GROWING HAM DEALER



FT-101E ICOM IC-211
Featuring - Yaesu, ICOM, Drake, Atlas, Den-Tron, Ten-Tec, Swan, Regency, Standard, Tempo, KLM, Hy-Gain, Mosley, Larsen, Midland, Wilson, Southwest Tech Products. We service everything we sell! Write or call for quote. YOU WON'T BE DISAPPOINTED. We are just a few minutes off the NYS Thruway (I-90) - Exit 32.

RADIO WORLD

ONEIDA COUNTY AIRPORT

TERMINAL BUILDING

ORISKANY, NY 13424

315-337-2622

Warren
K2IXN

Bob
WA2MSH

SEMTECH BRIDGES	
Heat sink w/center hole mtg. 10 Amp — Tested —	
200V P.I.V.	\$1.75 ea. ppd.
400V P.I.V.	\$1.95 ea. ppd.
600V P.I.V.	\$2.15 ea. ppd.
25 AMP — TESTED	
200V P.I.V.	\$2.25 ea. ppd.
400V P.I.V.	\$2.50 ea. ppd.
600V P.I.V.	\$2.85 ea. ppd.

NEW — LINE CORDS — US — 7 AMP
6' — Bk — 50¢ ea. 4/\$1.50 ppd.
8' — Gray — 60¢ ea. 4/\$1.90 ppd.

EDGEVIEW METERS 250 μ A 'S' METERS
NEW — \$2.65 ea. 3/\$7.25 ppd.

NEW SIZES — VERTICAL MOUNT
PC BOARD POTENTIOMETERS
American made (CRL) Cermet
sizes: 25K, 100K ohms. 5/\$1.30 ppd.
CTS Blue wheel. Values: 750, 1K,
1.5K, 50K, 300K ohms. 5/\$1.25 ppd.

m. weinschenker
electronic specialties-BOX 353, IRWIN, PA 15642

DIODES/ZENERS

1N914	100v	10mA	.05
1N4005	600v	1A	.08
1N4007	1000v	1A	.15
1N4148	75v	10mA	.05
1N753A	6.2v	z	.25
1N758A	10v	z	.25
1N759A	12v	z	.25
1N4733	5.1v	z	.25
1N5243	13v	z	.25
1N5244B	14v	z	.25
1N5245B	15v	z	.25

SOCKETS/BRIDGES

8-pin pcb	.25	ww	.45
14-pin pcb	.25	ww	.40
16-pin pcb	.25	ww	.40
18-pin pcb	.25	ww	.75
22-pin pcb	.45	ww	1.25
24-pin pcb	.35	ww	1.10
28-pin pcb	.35	ww	1.45
40-pin pcb	.50	ww	1.25
Molex pins .01	To-3 Sockets		.45
2 Amp Bridge	100-prv		1.20
25 Amp Bridge	200-prv		1.95

TRANSISTORS, LEDS, etc.

2N2222A	NPN (2N2222 Plastic .10)	.15
2N2907A	PNP	.15
2N3906	PNP (Plastic)	.10
2N3904	NPN (Plastic)	.10
2N3054	NPN	.35
2N3055	NPN 15A 60v	.50
T1P125	PNP Darlington	.35
LED Green, Red, Clear, Yellow		.15
D.L. 747	7 seg 5/8" High com-anode	1.95
XAN72	7 seg com-anode (Red)	1.25
MAN71	7 seg com-anode (Red)	1.25
MAN3610	7 seg com-anode (Orange)	1.25
MAN82A	7 seg com-anode (Yellow)	1.25
MAN74A	7 seg com-cathode (Red)	1.50
FND359	7 seg com-cathode (Red)	1.25

C MOS

4000	.15
4001	.15
4002	.20
4004	3.95
4006	.95
4007	.35
4008	.95
4009	.45
4010	.45
4011	.20
4012	.20
4013	.40
4014	.95
4015	.90
4016	.35
4017	1.10
4018	1.10
4019	.50
4020	.85
4021	1.00
4022	.85
4023	.25
4024	.75
4025	.30
4026	1.95
4027	.50
4028	.95
4030	.35
4033	1.50
4034	2.45
4035	1.25
4040	1.35
4041	.69
4042	.95
4043	.95
4044	.95
4046	1.75
4049	.45
4050	.45
4066	.95
4069	.40
4071	.35
4081	.70
4082	.45
MC14409	14.50
MC14419	4.85

7400	.15
7401	.15
7402	.20
7403	.20
7404	.15
7405	.25
7406	.35
7407	.55
7408	.25
7409	.15
7410	.10
7411	.25
7412	.30
7413	.35
7414	1.10
7416	.25
7417	.40
7420	.15
7426	.30
7427	.45
7430	.15
7432	.30
7437	.30
7438	.35
7440	.25
7441	1.15
7442	.45
7443	.65
7444	.45
7445	.65
7446	.95
7447	.95
7448	.65
7450	.25
7451	.25
7453	.20
7454	.25
7460	.40
7470	.45
7472	.40

7473	.25
7474	.30
7475	.35
7476	.40
7480	.55
7481	.75
7483	.95
7485	.75
7486	.25
7489	1.35
7490	.55
7491	.95
7492	.95
7493	.35
7494	.75
7495	.60
7496	.80
74100	1.15
74107	.35
74121	.35
74122	.55
74123	.55
74125	.45
74126	.35
74132	1.35
74141	.90
74150	.85
74151	.65
74153	.75
74154	.95
74156	.95
74157	.65
74161	.85
74163	.85
74164	.60
74165	1.50
74166	1.35
74175	.80

- T T L -

74176	1.25
74180	.75
74181	2.25
74182	.95
74190	1.75
74191	1.05
74192	.75
74193	.85
74194	1.25
74195	.95
74196	1.25
74197	1.25
74198	2.35
74221	1.00
74367	.85
75108A	.35
75110	.35
75491	.50
75492	.50
74H00	.15
74H01	.25
74H04	.20
74H05	.20
74H08	.35
74H10	.35
74H11	.35
74H15	.45
74H20	.30
74H21	.25
74H22	.40
74H30	.20
74H40	.25
74H50	.25
74H51	.25
74H52	.15
74H53J	.25
74H55	.20

74H72	.45
74H101	.75
74H103	.75
74H106	.95
74L00	.25
74L02	.25
74L03	.30
74L04	.30
74L10	.30
74L20	.35
74L30	.45
74L47	1.95
74L51	.45
74L55	.65
74L72	.45
74L73	.40
74L74	.45
74L75	.55
74L93	.55
74L123	.85
74S00	.35
74S02	.35
74S03	.30
74S04	.30
74S05	.35
74S08	.35
74S10	.35
74S11	.35
74S20	.35
74S40	.20
74S50	.20
74S51	.25
74S64	.20
74S74	.35
74S112	.60
74S114	.65

74S133	.40
74S140	.55
74S151	.30
74S153	.35
74S157	.75
74S158	.30
74S194	1.05
74S257 (8123)	1.05
74LS00	.25
74LS01	.35
74LS02	.35
74LS04	.30
74LS05	.45
74LS08	.25
74LS09	.35
74LS10	.35
74LS11	.35
74LS20	.25
74LS21	.25
74LS22	.25
74LS32	.40
74LS37	.35
74LS40	.45
74LS42	1.10
74LS51	.50
74LS74	.65
74LS86	.65
74LS90	.95
74LS93	.95
74LS107	.85
74LS123	1.00
74LS151	.95
74LS153	1.20
74LS157	.85
74LS164	1.90
74LS367	.75
74LS368	.75
74C04	.25
74C151	2.25

MCT2	.95
8038	3.95
LM201	.75
LM301	.45
LM308 (Mini)	.95
LM309H	.65
LM309K (340K-5)	.85
LM310	1.15
LM311D (Mini)	.75
LM318 (Mini)	.95
LM320K5 (7905)	1.65
LM320K12	1.65

LINEARS, REGULATORS, etc.

LM320T5	1.65
LM320T12	1.65
LM320T15	1.65
LM324N	.95
LM339	.95
7805 (340T5)	.95
LM340T12	1.00
LM340T15	1.00
LM340T18	1.00
LM340T24	.95
LM340K12	1.65

LM340K15	1.25
LM340K18	1.25
LM340K24	.95
78L05	.75
78L12	.75
78L15	.75
78M05	.75
LM373	2.95
LM380 (8-14 PIN)	.95
LM709 (8,14 PIN)	.25
LM711	.45

LM723	.50
LM725N	2.50
LM739	1.50
LM741 (8-14)	.25
LM747	1.10
LM1307	1.25
LM1458	.95
LM3900	.50
LM75451	.65
NE555	.50
NE556	.95
NE565	.95
NE566	1.75
NE567	1.35

9000 SERIES

9301	.85	95H03	1.10
9309	.35	9601	.45
9322	.75	9602	.45

MICRO'S, RAMS, CPU'S, ETC.

74S188	3.00
1702A	4.50
MM5314	3.00
MM5316	3.50
2102-1	1.45
2102L-1	1.75
TR1602B	4.50
TMS 4044-45NL	14.50
8080AD	12.00
8T13	1.50
8T23	1.50
8T24	2.00
8T97	1.00
2107B-4, A	4.00
2708	11.50

INTEGRATED CIRCUITS UNLIMITED

7889 Clairemont Mesa Boulevard, San Diego, California 92111
(714) 278-4394 (Calif. Res.)

All orders shipped prepaid

No minimum

Open accounts invited

COD orders accepted

Discounts available at OEM Quantities California Residents add 6% Sales Tax

All IC's Prime/Guaranteed. All orders shipped same day received.

24 Hour Toll Free Phone 1-800-854-2211

American Express / BankAmericard / Visa / MasterCard

SPECIAL DISCOUNTS

Total Order	Deduct
\$35 - \$99	5%
\$100 - \$300	10%
\$301 - \$1000	15%
\$1000 - Up	20%

WE'VE DONE IT AGAIN!

Announcing the new "SCANICOM"™ 245/211 scanner,* the ultimate accessory for your new ICOM radio.

"SCANICOM":

- Will scan the entire 2-meter band in 5 kHz steps (the radio's display tells you the frequency)
- Has a built-in delay that allows you to remain on frequency for a few seconds after the signal goes away
- Employs a connector that simply plugs into the back of your unit
- Requires only one wire to be added to your unit, and
- Comes complete with a fully illustrated instruction manual for fast, simple, installation
- Proper installation will not void warranty

\$39.95

Units available directly from **ESSARY ENTERPRISES** or from your local ICOM dealer. Call or write for details NOW.



* Patent Pending



ESSARY ENTERPRISES

P.O. Box 1731
Richardson, TX 75080
Tel: (214) 231-5866

flea market

THE TRI-STATE AMATEUR RADIO ASSN. (TARA) 16th annual hamfest, Sunday, June 4, 1978. 11:30 AM Camden Park, Rte. 60 West Huntington. Talk-in; WBVA/8, 04/64, 16/76, 34/94. For information and tickets write: TARA, P.O. Box 1295, Huntington, W.VA 25715.

ROME HAM FAMILY DAY will be held on June 4, 1978. For information write Rome Radio Club, PO Box 721, Rome NY 13440. (Dealer inquiries invited).

ILLINOIS: Egyptian Radio Club Annual Hamfest, Sunday, June 11, at club grounds, Granite City.

ILLINOIS — Six Meter Club of Chicago 21st annual ABC Hamfest, June 11, Santa Fe Park, 91st and Wolf Rd., Willow Springs. Tickets: Advance \$1.50; Gate \$2.00. Talk-in 146.94 FM or WR9ABC 37.97 (PL2A). Swap Row, Refreshments, AFMARS Meeting. Write: Val Hellwig, K9ZWW, 3420 South 60th Court, Cicero, IL 60650.

MICHIGAN S.P.A.R.K. Activities/Weekend, June 10th and 11th Newberry, Michigan. Saturday: fish fry, Tooner-ville Trolley and River Trip; Sunday: Annual SWAP and SHOP. Fun and enjoyment for all — hams, CBers, YLs, XYLs, children. Donations \$2 for registration and drawings; Tables \$1.50 and \$2.50. Talk-in on 01/61, 31/91, and 52 simplex. Contact W8GBR, Box 67, Newberry, MI 49868. Tel. 906-293-8651 for details.

"TIN LIZZY" INTERNATIONAL QSO PARTY — Saturday and Sunday, June 17 and 18 — commemorating the 75th anniversary of the Ford "Tin Lizzy" and sponsored by the Ford Amateur Radio League, an employee organization of the Ford Motor Company. Open to all amateurs throughout the world, on all bands 160 through 10 meters, the contest will run from 2400 UTC Friday, June 16th through 2400 UTC Sunday, June 18th. Work stations once per band, per mode — CW or ssb only. Call "CQ Tin Lizzy" on SSB, and "CQ TLC" on CW. For details of logs, exchanges, etc. contact The Tin Lizzy Contest, P.O. Box 932, Dearborn, Michigan 48121. Be sure to include a #10 SASE with 26¢ postage (U.S.) or an I.R.C. For other questions, contact K8BTH, 14468 Bassett Ave., Livonia, MI 48154; tel. (313) 464-9149 at home; or (313) 594-1779 at work.

MICHIGAN — Monroe County A.R.C. Annual Swap & Shop 8:00 AM to 4:00 PM Sunday, June 4th at Monroe County Community College, Raisinville Road (off M-50) Monroe, Michigan. Talk-in 13/73. Donation \$1 at gate. FREE tables and trunk sales. Details W8BULF, 3473 Vermont Court, Monroe, MI 48161.

INDIANA — Fifth Annual "Dad's Day" Hamfest, sponsored by Lake County A.R.C., 8:00 AM to 5:00 PM Sunday, June 18th, at the Izaak Walton League Picnic Grounds, Portage, Indiana. Take I-94 to Indiana 249 — Portage exit — then North 1/2 mile. Overnight camping, no hookups. Talk-in 146.52 or 84/24. Tickets \$2 donation at gate or \$1.50 advance. Details from TICKETS, Box 348, Griffith, Indiana 46319.

PONY EXPRESS CERTIFICATE — Available from the Missouri Valley A.R.C. to any ham who works the HF bands. Work 5 MVARC members, send 5 QSLs confirming QSOs and include two 13¢ stamps (U.S. hams); or 3 MVARC members and 3 confirming QSLs, plus one I.R.C. (DX hams) to WB0LVW, P.O. Box 141, Station E, St. Joseph, MO 64505. Also, list of MVARC stations from same address.

OHIO — The Goodyear A.R.C. 11th Annual Hamfest and Family Picnic, Sunday, June 11th, 10:00 AM to 6:00 PM at Wingfoot Lake Park, Akron, Ohio on county road 87 near Route 43. Many prizes, ample parking, shelters, picnic facilities, play areas for children, refreshments. Flea market and display space FREE to ticket holders. Family donation \$2.50 advance, \$3 gate. Details from W8BSXJ, 161 So. Hawkins Ave., Akron, OH 44313; tel. (216) 864-3665.

THE WEST WASHTENAW SWAP & SHOP, sponsored by the Dexter Amateur Radio Club — Chelsea Communications Club, at the Chelsea Fairgrounds, June 4th, 8:00 AM to 3:00 PM. Donations \$1.50 advance, \$2.00 gate. Table space \$.50 a foot, trunk sales \$1.00 per space.

EYEBALL FRIENDS July 16 Tri Club Hamfest, Allentown. Information SASE K3AI, RI Emmaus, Pennsylvania.

AMATEUR FAIR '78: SWAPFEST & EXPOSITION for Amateur Radio Operators and Computer Hobbyists. Saturday, June 3rd, Minnesota State Fairgrounds. Free overnight parking for self-contained campers, June 2 only. Talk-in on 16/76 and 52/52. Sell from your car in the GIANT FLEA MARKET. Inside space available. Great prizes, scheduled forums on FM and microprocessors. Admission: \$2.00. For information or reservations for commercial exhibit space, call (612) 933-2823.

Practical experience with
Superior Quality Materials
and Construction that's...

TOWER POWER by TRISTAO

Tristao isn't just a trade name... it's a man called Lou, and he's been designing towers for hams all his life...the pioneer. That's why Tristao towers above all. And because he knows hams, he engineers quality at prices you can afford. From Mini-Masts to the giants, it's TOWER POWER all the way with Tristao.

WRITE RIGHT NOW FOR FULL SPECS and dealer nearest you. PROMPT DELIVERY.

TRISTAO TOWER

Division of Palmer Industries, Inc.

415 E. 5th St. - P.O. Box 115

Hanford, CA 93230 / Ph. (209)582-9016

SYNTHESIZERS

We have the worlds largest selection of synthesizers for receivers, transmitters and transceivers. For complete details see our 1/3 page ad in the April 1976 issue of this magazine or call or write for additional information. Phone orders accepted between 9 AM and 4 PM EDT. (212) 468-2720

VANGUARD LABS

196-23 JAMAICA AVENUE

HOLLIS, N. Y. 11423

BIRD WATCHERS

Don't be absurd, buy a BIRD!
... from your Bird distributor

MODEL
43



\$120

ALL ITEMS AND ELEMENTS
ORDINARILY IN STOCK
Prepaid Shipment in Continental USA Only

MADISON ELECTRONICS SUPPLY, INC.

1508 McKINNEY HOUSTON, TEXAS 77002
713/658-0268 Nites 713/497-5683

SST T-1 RANDOM WIRE ANTENNA TUNER

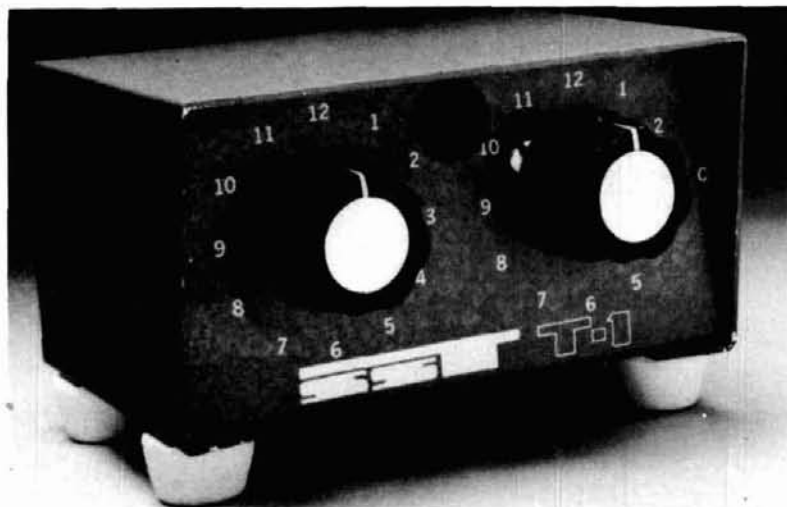

All band operation (160-10 meters) with any random length of wire. 200 watt output power capability—will work with virtually any transceiver. Ideal for portable or home operation. Great for apartments and hotel rooms—simply run a wire inside, out a window, or anyplace available. Efficient toroid inductor for small size: 4-1/4" x 2-3/8" x 3", and negligible loss. Built-in neon tune-up indicator. SO-239 connector. Attractive bronze finished enclosure.

only **\$29.95**

THE ORIGINAL Random Wire Antenna Tuner. . . in use by amateurs for 6 years.

SST T-2 ULTRA TUNER

Tunes out SWR on any coax fed antenna as well as random wires. Works great on all bands (80-10 meters) with any transceiver running up to 200 watts power output.

Increases usable bandwidth of any antenna. Tunes out SWR on mobile whips from inside your car.

Uses efficient toroid inductor and specially made capacitors for small size: 5-1/4" x 2-1/4" x 2-1/2". Rugged, yet compact. Negligible line loss. Attractive bronze finished enclosure. SO-239 coax connectors are used for transmitter input and coax fed antennas. Convenient binding posts are provided for random wire and ground connections.



only **\$39.95**



only **\$19.95**

SST T-3 Mobile Impedance Transformer

Matches 52 ohm coax to the lower impedance of a mobile whip or vertical. 12-position switch with taps spread between 3 and 52 ohms. Broadband from 1-30 Mhz. Will work with virtually any transceiver—300 watt output power capability. SO-239 connectors. Toroid inductor for small size: 2-3/4" x 2" x 2-1/4". Attractive bronze finish.

GUARANTEE

All SST products are guaranteed for 1 year. In addition, they may be returned within 10 days for a full refund (less shipping) if you are not satisfied for any reason. Please add \$2 for shipping and handling. Calif. residents, please add sales tax. COD orders OK by phone.

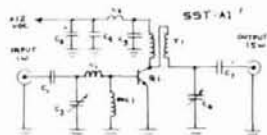

only **\$29.95**

\$49.95 wire and tested

SST A-1 VHF Amplifier Kit

1 watt input gives you 15 watts output across the entire 2 meter band without re-tuning. This easy-to-build kit (approx. 1/2 hr. assembly) includes everything you need for a complete amplifier. All top quality components. Compatible with all 1-3 watt 2-meter transceivers. Short and open protected—not damaged by high SWR.

Kit includes:

- Etched and drilled G-10 epoxy solder plated board.
- Heat sink and mounting hardware. All components—including pre-wound coils.
- Top quality TRW RF power transistor.
- Complete assembly instruction with details on a carrier operated T/R switch.



ELECTRONICS

P.O. BOX 1 LAWDALE, CALIF.
90260 • (213) 376-5887



**There's
nothing
like it !**

**RADIO AMATEUR
callbook**

*Respected worldwide as
the only complete authority
for radio amateur
QSL and QTH information.*

The **U. S. Callbook** has over 300,000 W & K listings. It lists calls, license classes, names and addresses plus the many valuable back-up charts and references you come to expect from the **Callbook**.

Specialize in DX? Then you're looking for the **Foreign Callbook** with almost 300,000 calls, names and addresses of amateurs outside of the USA.

U.S. Callbook \$14.95

Foreign Callbook \$13.95

Order from your favorite electronics dealer or direct from the publisher. All direct orders add \$1.50 for shipping. Illinois residents add 5% Sales Tax.

**RADIO AMATEUR
callbook INC**
Dept. E 925 Sherwood Drive
Lake Bluff, Ill. 60044

flea market

JUNE 4, 1978, STARVED ROCK RADIO CLUB HAMFEST, Bureau County Fairgrounds, Princeton, Illinois. Advance registrations \$1.50 before May 25, after \$2.00. Large SASE please for registrations, map, information, etc. W9MKS/WR9AFG/SRR, RFD #1, Box 171, Oglesby, Illinois 61348. 815-667-4614.

ALASKA: ARRL Convention, Anchorage. August 26, 27. Write: ARRL Alaska Convention 78, Anchorage ARC, PO Box 1987, Anchorage, AK 99510.

WIMU (Wyoming, Idaho, Montana, Utah) The 46th Annual WIMU Hamfest is scheduled for August 4, 5, and 6, 1978 at Mack's Inn, Idaho; 25 miles South of West Yellowstone, Montana. Talk-in 146.34/94 and 3935. Advance registration: \$6.00 for adults and \$2.00 for children, before July 25th, 1978. Late/regular registration: \$7.00 and \$2.50. **SPECIAL PRIZE DRAWING FOR PRE-REGISTRATION.** Please send pre-registration to: WIMU Hamfest, 3645 Vaughn Street, Idaho Falls, Idaho 83401. Phone (208) 522-9568.

CENTRAL MICHIGAN Amateur Repeater Association Fourth Annual Swap & Shop in Midland, Michigan, June 3rd at the Midland County Fairgrounds. Camping & Program Friday evening. Computer Demonstrations, Door Prizes. Donation: \$2.00 at door, \$1.50 in advance. Talk-in: 146.07/146.67 WR8AKN, 146.13/146.73 WR8AHM and 146.52 Simplex. Info & Tickets, SASE to Don Zahm, WB8SDJ, 3871 Monroe R#8, Midland, MI 48640.

ANNUAL TEXAS VHF-FM SOCIETY SUMMER CONVENTION, hosted by the Houston Echo Society, August 4, 5, 6, 1978 at the Galleria Plaza Hotel off Interstate Loop 610 at Westheimer Road. Microprocessors/microcomputers, hidden transmitter hunt, OSCAR communications, VHF-FM activities. ARRL & FCC forums, open hospitality suite, ladies' activities, AstroDome-Astroworld tours for the kids, Exhibitors, and prizes. Saturday night banquet featuring Bill Tynan, W3XO, editor of QST's "World Above 50 MHz", as guest speaker. For information and reservations write FM Society Summer Convention, P.O. Box 717, Tomball, Texas 77375.

MANASSAS HAMFEST SPONSORED BY The "Ole Virginia Hams" A.R.C. June 4, 1978 at the Prince William County Fairgrounds one-half mile south of Manassas, Virginia on Rt. 234. Gates open 7 AM for tailgating, 8 AM for general admission. Fantastic Prizes. Admission \$3.00 adult, under 12 free. Tailgating \$2.00 per vehicle, over 300 spaces available. Refreshments, YL Program, Children's entertainment, FM Clinic; QSL Bureaus: learn how they work. CW Proficiency awards: 5 wpm up. Indoor exhibit space available for Dealers: for info contact Sam Lebowich, 9512 Sudley Manor Dr., Manassas, VA 22110. Talk-in on 146.37/146.97, 147.84/147.24 and CB Ch. 1. Accommodations: Olde Towne Inn in Manassas, Holiday Inn at I-66 and Rt. 234 Interchange. Camping at Prince William County Forest (on Rt. 234 near the intersection of 234 and I-66).

HAMFESTERS 44TH ANNUAL PICNIC AND HAMFEST, Sunday, August 13, 1978 at Santa Fe Park, 91st and Wolf Road, Willow Springs, Illinois, Southwest suburb of Chicago. Exhibits for OM's and XYL's, FAMOUS SWAPPERS ROW. Tickets at gate \$2.00, Advance \$1.50. For Hamfest info or Advance Tickets (send check or money order — SASE appreciated) to Bob Hayes W9KXW, 18931 Cedar Ave., Country Club Hills, IL 60477.

SATELLITE AMATEUR RADIO CLUB Annual Swap/Fun fest and Santa Maria BBQ on Sunday, June 18. Best steak and biggest hamfest in the west. Fantastic prizes! Swap tables available. All you can eat dinner — \$6.00 adults; \$3.00 children under 12. Contact W2KVA/6 at (805) 925-0398, or write SWAPFEST, P.O. Box 2531, Orcutt, CA 93454.

Stolen Equipment

STOLEN FROM AIRLINE BAGGAGE, probably either in Minneapolis/St. Paul or San Francisco, Wilson WE-800 s/n 12521811 with 10 white "no brand" Ni-Cad batteries inside, flex antenna with UHF eil connector and UHF to BNC connector. Also homebuilt battery charger with 723 IC. Mitt Nodacker, WA7TFE, Box 2632, Pocatello, ID 83201.

STOLEN EQUIPMENT: 1. KLM 160 watt amplifier, no I.D. 2. Black Heath 2036 with Micoder and several obvious modifications: hi-low power selector on squelch knob, variable power on internal potentiometer, RCA plug replaced with SO-239, Social Security No. 350-30-1717 etched in foil on transmitter board. Darrel Dorsett, K9JKZ, Kankakee Area Career Center, Rt. 2, Road 100-W, Bourbonnais, IL 60914.

432 Yagis by K2RIW

IF YOU'RE SERIOUS
ABOUT 432...

... MEET RIW's
432-19

- 1st PLACE - EAST COAST VHF SOCIETY'S 1977 ANTENNA GAIN CONTEST
- 19 ELEMENTS, TANDEM-REFLECTOR*
- 12-MHz BANDWIDTH, 432-MHz CF
- INTEGRAL BALUN, 50 Ω TYPE N
- ALL ELEMENTS INSULATED FROM BOOM-NO GAIN LOSS FROM WEATHERING!
- HANDLES FULL KILOWATT CW
- 13-FT SELF-SUPPORTING BOOM
- SURVIVES 85-MPH WINDS
- WEIGHS ONLY 2-3/4 POUNDS!

*PATENT PENDING

MODEL \$49⁹⁵ PREPAID UPS IN
432-19 CONTINENTAL USA

QUANTITY DISCOUNTS AVAILABLE - WRITE

riw PRODUCTS

BOX 191, BABYLON, N.Y. 11702

COPY MORSE CODE

with the new MVD-1000
MORSE VIDEO DISPLAY

- Enjoy Morse Code copy on your TV screen
- Displays letters, numbers, and punctuation
- 16 lines of 32 characters per page
- 2 page display with Recall feature
- Automatic scrolling
- Automatic or Manual speed control
- Copy Morse Code from 6-60 WPM
- Easily connects between receiver and TV set

Write for more information

MK-1 Memory Keyer \$169.95
CMOS PCB Keyer \$24.95

DGM ELECTRONICS

787 BRIAR LANE, BELOIT, WIS. 53511

GOING 2 OR 220?

GET ON WITH THE BEST:



Midland 13-510
• Synthesized
• 144-148 MHz
• 1 or 25 watts
Reg. \$399.95

OUR PRICE \$348⁷⁵

Master Charge and VISA welcome.



Midland 13-513
• Synthesized
• 220-225 MHz
• 1, 10, 20 watts
Reg. \$499.95

OUR PRICE \$438⁷⁵



burbank electronics, inc.
2308 MAGNOLIA BOULEVARD
BURBANK, CALIFORNIA 91506
(213) 843-1647

 CCK'S DPDT PUSH BUTTON SWITCH. \$1.50	50 ohm COAX RG 174 U 50 FT. \$2.75	.1 ohm FIVE WATT RESISTOR 5/\$1.00	 SO-239 65C PL-259 65C 10/\$6.00 MIX/MATCH	CIGARETTE LIGHTER PLUG  79c	1N914 NEW HOUSE MARKED 100 for \$2.95	NYLON CABLE TIES  4 INCH 100/\$1.00 6 INCH 100/\$1.75
1N4007 1000 PIV AT 1 AMP NEW 8c PRIME	toggle switch P-C OR PANNEL MOUNT MINI SWITCH SPDT \$1.00 10/\$8.	HEAT Shrink ASSORTED SIZES 10 FOOT BUNDLE 95c	MJE3055 90 WATTS 60VCE 10 AMPS NPN 2/\$1.50	MOLEX PINS  200 EACH \$1.95 1000 EACH \$7.95	MALORY SONALERT electronic signal MADE IN U.S.A. 6 TO 28 VOLTS \$5.50	30 AWG wire wrap LT. GREEN DK. GREEN RED 100 FT. \$2.50
 CHROMERICS PAD HAS A COMMON TERMINAL AND A TERMINAL FOR 0-9 CANCEL AND SEND. A GREAT VALUE FOR \$4.50	 ULTRASONIC TRANSDUCER WITH RCA JACK 37 KHZ \$1.95 40 KHZ \$1.95	KEYBOARDS THESE KEYBOARDS ARE FACTORY NEW IN THE BOX. FORTY-SEVEN KEYS, MOS ENCODED, DUAL MODE AND EBCDIC. (EXTENDED BINARY CODED DECIMAL CODE.) THE BUTTON KEY TOPS ARE GRAY AND WHITE. COMPLETE DOCUMENTATION IS GIVEN WITH EACH KEYBOARD, EASY TO MOUNT. (BRACKET INCLUDED) THIS FINE QUALITY KEYBOARD, WITH ORIGINAL COST OF \$96.00, IS NOW OFFERED TO YOU FOR ONLY... \$19.95		TYPE WATT IC VCE0 MJ1000 NPN 90 B 60 \$1.25 MJ900 PNP 90 B 60 \$1.65		
 SOLDER TAIL IC SOCKETS 8 PIN \$.20 14 PIN \$.18 16 PIN \$.18 24 PIN \$.35 40 PIN \$.85	 MDA 970-2 BRIDGE 100 PIV 4 AMP. \$.75 10/\$1.00	 N/CADS 4 'AA' SIZE CELL 500 MILL. AT 5 V \$3.95	 THUMBWHEEL SWITCH BCD SINGLE MOUNT 12 POSITION 0-11 \$1.25 5/\$6.00	 CRYSTAL OSCILLATOR 4 MHz OSC. DIP SQU.WAVE Vcc 5V \$3.50	 BOXER FANS 100CFM 4.5 INCH FAN OPENING 1.5 INCHS DEEP EXHAUST DR B 115 VOLT A.C. USED BUT GUARANTEED \$6.95 "NEW" MUFFIN FANS SAME SPEC. AS ABOVE EXCEPT NEW IN FACTORY BOXES \$12.95	
 WIREWRAP IC SOCKETS 14 PIN \$.35 16 PIN \$.38 24 PIN \$.75 40 PIN \$.95	 115 VOLT OUTLET WITH SWITCH TAKES A 1X2 7/16IN. HULL \$.75 3/\$2.00	 T-TONE PAD HOUSING BLACK ONLY \$2.75	 BNC-F/BNC-F UG-914U \$2.00	 BNC-F/UHF-M UG-273U \$2.50	 Variable Power Supply *12-28V ADJUSTABLE POWER SUPPLY AT 28V 250MA THERMALLY PROTECTED. * 5-12V ADJUSTABLE POWER SUPPLY AT 12V 500MA ADJUSTABLE P.T. ALL PARTS INCLUDED *TRANSFORMER *POT & RESISTOR *OSC. SUPPRESSION CAP. *1000UF CAP. *REGULATOR 7805 OR 7812 *PC BOARD *HEAT SINK *DIODES *INSTRUCTIONS *HARDWARE P51 5-12V \$5.95 P52 12-28V \$5.95	
 UG-914U \$1.50	 UG-255U \$3.00	 UG 157 \$.25	 UG-349U \$3.75	 UG-146U \$4.25		
	MARLIN P JONES & ASSOCIATES PO BOX 9023 RIVIERA BEACH, FLORIDA 33404 (305) 848-8236		*FLA. RESIDENTS ADD .4% *MASTER CHARGE AND VISA ACCEPTED *ADD \$1.00 FOR ORDERS UNDER \$10.00 *USA ORDERS ADD 5% FOR SHIPPING *FOREIGN PLEASE ALLOW SUFFICIENT POSTAGE			

VHF-FM RECEIVER

Compact — High Performance

LOW COST KIT

Model 144-5

Sensitivity under .15 μ V SINAD



ACCESSORIES

- Handsome Compact Aluminum Case \$9.95
- Speaker / Control Kit \$19.95

Electronic Signal Products, Inc.
2250 G Landmeier Rd., Elk Grove, IL 60007 (312) 364-0080

Also models for 29, 50, 220 and 440 MHz
Commercial versions for other frequencies can also be supplied

Illinois residents add 5% sales tax
144-5 receiver kits at \$59.95 each

BANK AMERICARD Please ship 29 50 220 receiver kits at \$59.95 each 440 kit at \$69.95

VISA Please ship 29 50 220 receiver kits at \$59.95 each 440 kit at \$69.95

Name _____ Call _____
Address _____
City _____
State _____ Zip _____

Check or money order for \$ _____ enclosed
 Charge my VISA/BankAmericard # _____
Card expires _____ Signature _____

NEW 1978 EDITION

1978 EDITION \$4.00

AMATEUR RADIO EQUIPMENT DIRECTORY



The most complete directory of Amateur Radio Equipment ever published. The all new 1978 Edition includes specifications, pictures, and prices of transceivers, transmitters, receivers, amplifiers, power supplies, transverters, antennas, tuners, towers, meters, microphones, keyers, VFO's, preamps, test gear, etc. etc. No ham library will be complete without a copy of the 1978 Amateur Radio Equipment Directory.

\$4.00 Postpaid (U.S.)
Canada \$5.00, Foreign (Air) \$7.00

KENGORE CORP. Dept. HR
9 James Avenue
Kendall Park, N. J. 08824

SEND FOR YOUR COPY TODAY

CALL TOLL FREE

I-800-228-4097

Antenna Sale!

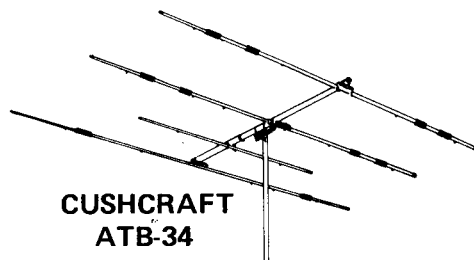

CUSHCRAFT
ATB-34

		MOSLEY	Regular	Special
Classic 33	3 ele. 10, 15, 20 Mtr. beam		\$232.50	\$189.95
Classic 36	6 ele. 10, 15, 20 Mtr. beam		310.65	249.95
TA-33	3 ele. 10, 15, 20 Mtr. beam		206.50	169.95
TA-36	6 ele. 10, 15, 20 Mtr. beam		335.25	279.95
TA-33 Jr.	3 ele. 10, 15, 20 Mtr. beam		151.85	129.95
TA-40KR	40 Mtr. add on		92.25	74.95

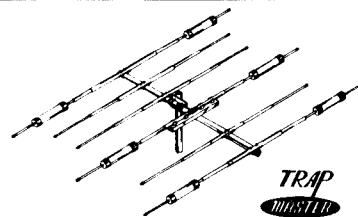

MOSLEY CL-36

		CUSHCRAFT		
ATB-34	4 ele. 10, 15, 20 Mtr. beam		239.95	199.95
ARX-2	2 Mtr. Ringo Ranger		32.95	29.95
A147-20T	2 Mtr. Twist		54.95	47.95
A144-10T	10 ele. Twist 2 Mtr.		34.95	31.95
A144-20T	20 ele. Twist 2 Mtr.		54.95	47.95
A14T-MB	Mounting Boom		15.95	14.95

		HUSTLER		
4BTV	10-40 Mtr. Trap Vertical		99.95	82.95
RM-75	75 Meter Resonator		15.50	13.50
RM-75s	75 Meter Super Resonator		30.00	26.50
G6-144-A	6 db. 2 Mtr. Base Colinear		67.55	57.95

		HY-GAIN		
TH6-DXX	Super Thunderbird		249.95	209.95
TH3-MK3	3 ele. 10, 15, 20 Mtr. beam		199.95	169.95
Hy-Quad	2 ele. Quad 10, 15, 20 Mtr.		219.95	189.95
TH3-Jr.	3 ele. 10, 15, 20 Mtr. beam		144.50	129.95
18 HT	Hy-Tower 10-80 Mtr. Vertical		279.95	239.95
14AVQ/WB	10-40 Mtr. Trap Vertical		67.00	57.00
18AVT/WB	10-80 Mtr. Trap Vertical		97.00	84.95
203	3 ele. 2 Mtr. beam		12.95	
205	5 ele. 2 Mtr. beam		16.95	
208	8 ele. 2 Mtr. beam		19.95	
214	14 ele. 2 Mtr. beam		26.95	

		WILSON		
System One	5 ele. 10, 15, 20 Mtr. beam		259.95	239.95
System Two	4 ele. 10, 15, 20 Mtr. beam		199.95	185.00

CDE ROTORS

Ham III	\$125.00
T2X Tail Twister	\$249.00
CD-44	\$105.00

Call for SUPER price on Consolidated Tower and Berk-Tec Coax Cable

18HT

Open seven days a week

RINGO
RANGER

4BTV
HUSTLER
the home of originals



Communications Center

The Radio Store

443 N. 48th, Lincoln, Nebraska 68504

In Nebraska Call (402)466-8402



1-800-432-1234

1-800-233-0250

1-800-527-4634

1-800-527-4634

1-800-645-9187

1-800-233-0250

1-800-432-1234

Don't play the numbers!

Just call us... Toll Free!

1-800-325-3636

FOR NEW OR USED AMATEUR RADIO GEAR... we're specialists and carry in stock most of the famous-brand lines. Or, we will talk trade.

FOR FAST, DOOR-STEP DELIVERY... give us a call. You'll be amazed; for we guarantee we'll ship your equipment the same day. Plus, most shipments are PRE-PAID.

TO SAVE MONEY... join thousands of our satisfied customers who buy from us as easily as from their local supplier. So, remember your call is Toll Free.



We welcome your Master Charge or VISA/BankAmericard.

HAM RADIO CENTER

8340-42 Olive Blvd. P.O. Box 28271 St. Louis, MO 63132



"THE PROFESSIONALS"

NEW

MODEL CTR-2A • 500 MHz & 1 GHz

COUNTERS

NEW Period Measurement

1 us to 1 sec.



NEW Built-in Pre-Amp

10 mv @ 150 MHz

The New Model CTR-2A Series Counters are designed and built to the highest standards to fulfill the needs of commercial communications, engineering labs and serious experimenters. With an accuracy of + .00005% (oven option) the CTR-2A can handle the most critical measurements and is about half the cost of other commercial counters.

If you need a reliable counter at an affordable price, the CTR-2A is the answer.

- Built-in Pre-Amp 10 mv @ 150 MHz
- 8 Digit .3" LED Display
- High Stability TCXO Time Base
- Built-in VHF-UHF Prescaler
- Automatic Dip Placement
- TCXO Std. ± 2 ppm
- Period Measurement (Optional)
- Input Diode Protected
- 12V-DC Operation (Optional)
- Oven Controlled Crystal (Optional) $\pm .5$ ppm
- Selectable Gate Times - 1 & 1 sec.

500 MHz Kit CTR-2A-500K	\$249.95
500 MHz Assembled CTR-2A-500A	349.95
1GHz Kit CTR-2A-1000K	399.95
1GHz Assembled CTR-2A-1000A	549.95

OPTIONS

02) Oven Crystal	\$49.95	05) 10 sec. Time Base	\$ 5.00
03) .43" LED	10.00	06) Period	15.00
04) 12 V-DC	10.00	07) Handle	10.00



DAVIS ELECTRONICS 636 Sheridan Dr., Tona., N.Y. 14150 716/874-5848

PROBES

Hi-Z
\$15.00

•
Low Pass
\$15.00

NEW FROM GLB

A complete line of **QUALITY 50 thru 450 MHz TRANSMITTER AND RECEIVER KITS**. Only two boards for a complete receiver. 4 pole crystal filter is standard. Use with our **CHANNELIZER** or your crystals. Priced from \$69.95. Matching transmitter strips. Easy construction, clean spectrum, **TWO WATTS** output, unsurpassed audio quality and built in **TONE PAD INTERFACE**. Priced from \$29.95.

SYNTHESIZER KITS from 50 to 450 MHz. Prices start at \$119.95.

Now available in **KIT FORM** — GLB Model 200 **MINI-SIZER**.

Fits any HT. Only 3.5 mA current drain. Kit price \$159.95 Wired and tested. \$239.95

Send for **FREE 16 page catalog**.

We welcome Mastercharge or VISA

GLB ELECTRONICS

1952 Clinton St., Buffalo, N. Y. 14206

ALUMA TOWERS

60 Ft.
Ham Crank-Up
Model T-60-H

40 Ft.
Crank-Up
Ham Model T-140

HIGHEST QUALITY

MADE IN ALUMINUM

- ★ TELESCOPING (CRANK UP)
- ★ GUYED
- ★ TILT OVER MODELS

QUALITY MADE

Excellent for

HAM COMMUNICATIONS

MANY MODELS MFG.

Towers to 100 feet. Specials designed & made. See dealer or send for free catalog.

ALUMA TOWER CO.
BOX 2806HR
VERO BEACH, FLA. 32960
PHONE (305) 567-3423

Radio Amateurs Reference Library of Maps and Atlas



WORLD PREFIX MAP — Full color, 40" x 28", shows prefixes on each country . . . DX zones, time zones, cities, cross referenced tables **\$1.25**

RADIO AMATEURS GREAT CIRCLE CHART OF THE WORLD — from the center of the United States! Full color, 30" x 25", listing Great Circle bearings in degrees for six major U.S. cities; Boston, Washington, D.C., Miami, Seattle, San Francisco & Los Angeles. **\$1.25**

RADIO AMATEURS MAP OF NORTH AMERICA! Full color, 30" x 25" — includes Central America and the Caribbean to the equator, showing call areas, zone boundaries, prefixes and time zones, FCC frequency chart, plus useful information on each of the 50 United States and other Countries **\$1.25**

WORLD ATLAS — Only atlas compiled for radio amateurs. Packed with world-wide information — includes 11 maps, in 4 colors with zone boundaries and country prefixes on each map. Also includes a polar projection map of the world plus a map of the Antarctica — a complete set of maps of the world. 20 pages. Size 8 3/4" x 12" **\$2.50**

Complete reference library of maps — set of 4 as listed above **\$3.75**

See your favorite dealer or order direct.
Mail orders please include \$1.25 per order for shipping and handling.

RADIO AMATEUR **callbook INC.**

WRITE FOR FREE BROCHURE!



Dept. E 925 Sherwood Drive
Lake Bluff, Ill. 60044

BULLET ELECTRONICS

P. O. BOX 19442 DALLAS, TEXAS 75219

PHONE ORDERS (214/823-3240) ON MASTERCARD & VISA

New!

ULTRASONIC SENDER-RECEIVER KIT US-02

TOTAL SECURITY! Completely invisible ultrasonic (23KHZ) Sound beam works like a photoelectric beam but is unaffected by light, heat or noise. Separate Transmitter and Receiver can be used from 6 inches to 25 feet! A solid object breaking the beam causes an output to go low that will sink up to 150 MA to Drive a Relay, TRIAC, etc. Complete electronics are provided. Works on 12VDC (unregulated) and draws less than 100 MA. Use it for burglar alarms, object counters, automatic door openers, automatic door bells, electronic rat trap(?) and more.

COMPLETE KIT LESS CASES **21.50**

Optional entry delay and Alarm Time-out Circuit **3.95**
will source or sink up to 200 MA DC.

PS-14 HIGH CURRENT REGULATED POWER SUPPLY KIT

A low cost, no frills, heavy duty power supply. Designed for use and abuse!

12V @ 15A CONTINUOUS Less Case, meters & jacks

- Better than 200MV load & line regulation
- Foldback Current Limiting
- Short Circuit Protected
- Thermal Shutdown
- Adjustable Current Limiting
- Less than 1% ripple.
- 15 amps 11.5 to 14.5V
- All parts supplied including heavy duty transformer.
- Quality plated fiberglass PC board.

39.95

UPS SHIPPING PAID!

POWER SUPPLY ACCESSORIES

Quality 3 1/2" Meters for PS-14 (0-25A; 0-15 VDC) Individually Packaged. Not Surplus **\$12.95/set**

Cheap insurance for expensive equipment. Protects your equipment from overvoltage conditions. Circuit fires an SCR that clamps the output to ground when the trip point is reached. Adjustable from 3 to 30 VDC. For use on fused power supplies. Complete with PC board & all necessary components. No power supply required.

ORDER OVP-1

6.95

SPECIAL SALE
TIL 312 LED Common Anode
7 Segment Redout
3" Character Size
Standard Pinout while they last
65
6/3 00

Miniature 7k Pot w/switch PC Mount or panel mount 1/8" shaft
49
Black plastic knob for above.
FREE

LIMITED QTY
Computer Grade FILTER CAP
Screw Terminals
2 1/2" x 5/8" 9500 mfd@75V
2.95 or
4/9.95

HEATSHRINK TUBING
A very good Assort of 3/32", 1/8", 3/16" & 1/4" in 6 inch lengths 12 pieces total
75
This item FREE with purchase of 15.00 or more

MOBILE CLOCK CALENDAR KIT

Seems like everybody sells digital clock kits, however we have the only low cost **DIGITAL CLOCK / CALENDAR** for mobile operation. We provide quality plated through hole boards and step-by-step instructions, parts overlays and schematics. This clock has many features and we supply all the parts but a small speaker. Fantastic for car, boat or Van.

- Integral Timebase (0.1% ACC)
- Large 1/2" 4 DIGIT LED display with AM/PM indicators
- Flashing colon at 1 Hz rate
- Special noise and overvoltage protection for mobile use
- Auxiliary output will drive relay or TRIAC to control external equipment
- Built in ignition blanking turns off readouts when not in use
- Pretable alarm with " Snooze"
- Special "SleepTimer"

23.50 NO CASE

12 VAC XFMR for 110 VAC **3.50**
24 Hour Format add **2.00**

MG-01 ELECTRONIC GRANDFATHER CLOCK

While we are talking about clocks check out the **MINI GRANDFATHER CLOCK** Reviewed in April 1978 **RADIO ELECTRONICS**. We have the only kit in the world with all the below listed features. The biggest problem is to describe how unique and fascinating this timepiece really is! The LED "Swinging" Pendulum and Matching Tick-Tock Sound are available only on our clock. In addition the electronic "bell" notes each hour (ie 3 times for 3 o'clock). Housed in the optional Solid Hardwood Case, the unit makes a beautiful addition to any room.

- 1/2" 4 DIGIT LED READOUT
- Adjustable tone & duration on chime
- Simulated swinging LED Pendulum
- All CMOS Construction
- Quality plated boards
- All electronic switches + and XFMR included

39.95 KIT 59.95 ASEMB.

Optional Solid Hardwood Case for MG-01 Clock over 10 inches tall. Includes Rubr front. Unassembled. **SOLID HARDWOOD 17.95 SOLID WALNUT 19.95**

Parts

MC1469R	1/4 positive Voltage Reg.	House	1.25
MC1351P	FM IF and Sound System		.50
CA3011	Wideband IF Amp IC	House	.50
MM5375	6 Digit Alarm Clock Chip		2.95
555	Timer & Pulse Gen Chip		.49
741	Op amps 8 pin MINI DIP		.20
LM3900	QUAD OP AMP		.45
723	Pos Voltage Reg DIP		.65
725	Ultra low noise high gain Op amp	House	.99
NE565A	PLL DIP		.50
TCA430	Quad Audio Oscillator Dip		.69
MJ900, MJ1000	Matched Pair BA Darlington	Pair/3.00	
IN4148	Switching Diodes		25/1.00
2N3569	NPN Silicon Switching		6/1.00
2N2712	NPN Small Signal		8/1.00
2N4343	P Channel J Fet		4/1.00
2N6028	Programmable Unijunction		2/1.00
2N6111	PNP Med Power 30W T0220		3/1.00

CAPS		
.022	@ 100VDC Mylar	8/1.00
.22	@ 50VDC Mylar	6/1.00
1.5mfd	@ 400VDC Mylar	4/1.00
.1mfd	@ 35V Tant Axial	6/1.00
.47mfd	@ 35V Tant Axial	6/1.00
2.2mfd	@ 35V Tant Axial	5/1.00
22mfd	@ 20V Dip Tant	4/1.00
33mfd	@ 10V Dip Tant	4/1.00
220mfd	@ 25V Alum. Axial	7/1.00
500mfd	@ 35V Alum. Axial	5/1.00
1100mfd	@ 35V Alum. Axial	4/1.00

• ZENER GRAB BAG. A very nice assortment of 10 different voltages between 2.7v and 30 VDC in 400 MW, 5W and 1W. All are prime units but most have Mfg's numbers. We supply a cross reference sheet to standard numbers.

SPECIAL PRICE 10 pieces 1.00

THE SMALL PRINT

- No COD's
- Check or MO 5% for shipping
- MC/VISA
- TX residence
- add 5% Sales tax
- Orders under \$10 add 10% for shipping handling
- All orders add 5% for shipping
- Orders over \$50 take 10% discount
- Foreign address add 10% for shipping handling



Ham Radio's guide to help you find your local

Alabama

LONG'S ELECTRONICS

2808 7TH AVENUE SOUTH
BIRMINGHAM, AL 35202
800-633-3410

Call us Toll Free to place your order

Alaska

RELIABLE ELECTRONICS

3306 COPE STREET
ANCHORAGE, AK 99503
907-279-5100

Kenwood, Yaesu, DenTron, Wilson,
Atlas, ICOM, Rohn, Tri-Ex.

Arizona

HAM SHACK

4506 A NORTH 16TH STREET
PHOENIX, AZ 85016

602-279-HAMS

Serving all amateurs from
beginner to expert.

KRYDER ELECTRONICS

5520 NORTH 7TH AVENUE
NORTH 7TH AVE. SHOPPING CTR.
PHOENIX, AZ 85013

602-249-3739

We service what we sell.

POWER COMMUNICATIONS

6012 NORTH 27th AVE.
PHOENIX, AZ 85017

602-242-6030

Arizona's #1 Ham Store.

Kenwood, Drake, ICOM & more.

QSA 599 AMATEUR RADIO CENTER

11 SOUTH MORRIS STREET
MESA, AZ 85202

602-833-8051

Eimac Distributor. New & Used
Equipment, Parts - Surplus tool

California

C & A ELECTRONIC ENTERPRISES

2529 EAST CARSON ST.

P. O. BOX 5232

CARSON, CA 90745

213-834-5868

Not the Biggest, but the Best —
since 1962.

COMMUNICATIONS CENTER

705 AMADOR STREET

VALLEJO, CA 94590

707-642-7223

Who else has a Spectrum
Analyzer?

HAM RADIO OUTLET

999 HOWARD AVENUE

BURLINGAME, CA 94010

415-342-5757

Visit our stores in Van Nuys
and Anaheim.

QUEMENT ELECTRONICS

1000 SO. BASCOM AVENUE

SAN JOSE, CA 95128

408-998-5900

Serving the world's Radio Amateurs
since 1933.

TOWER ELECTRONICS CORP.

24001 ALICIA PARKWAY

MISSION VIEJO, CA 92675

714-768-8900

Authorized Yaesu Sales & Service.

Mail orders welcome.

Colorado

MILE-HI COMMUNICATIONS, INC.

1970 SOUTH NAVAJO

DENVER, CO 80223

303-936-7108

Rocky Mountain's newest
ham store. Lee Tingle KØLT.

Connecticut

ARCOMM ELECTRONICS

2865 MAIN STREET

BRIDGEPORT, CT 06606

203-335-9850

Featuring Ten-Tec and DenTron.

AUDIOTRONICS INC.

18 ISAAC STREET

NORWALK, CT 06850

203-838-4877

The Northeast's fastest growing
Ham Dept. dedicated to service.

Florida

AGL ELECTRONICS, INC.

1800-B DREW ST.

CLEARWATER, FL 33515

813-461-HAMS

West Coast's only full service
Amateur Radio Store.

MARC'S

CENTRAL EQUIPMENT CO., INC.

18451 W. DIXIE HIGHWAY

NORTH MIAMI BEACH, FL 33160

305-932-1818

See Marc, WD4AAS, for complete
Amateur Sales & Service.

RAY'S AMATEUR RADIO

1590 US HIGHWAY 19 SO.

CLEARWATER, FL 33516

813-535-1416

West coast's only dealer:
Drake, Icom, Cushcraft, Hustler.

Illinois

ERICKSON COMMUNICATIONS, INC.

5935 NORTH MILWAUKEE AVE.

CHICAGO, IL 60646

312-631-5181

Hours: 9:30-5:30 Mon, Tues, Wed,
Fri; 9:30-9:00 Thurs; 9:00-3:00 Sat.

KLAUS RADIO, INC.

8400 NORTH PIONEER PARKWAY

PEORIA, IL 61614

309-691-4840

Let us quote your Amateur needs.

SPECTRONICS, INC.

1009 GARFIELD STREET

OAK PARK, IL 60304

312-848-6777

Chicagoland's Amateur Radio
leader.

Indiana

HOOSIER ELECTRONICS, INC.

P. O. BOX 2001

TERRE HAUTE, IN 47802

812-238-1456

Ham Headquarters of the Midwest.
Store in Meadows Shopping Center.

KRYDER ELECTRONICS

GEORGETOWN NORTH

SHOPPING CENTER

2810 MAPLECREST RD.

FORT WAYNE, IN 46815

219-484-4946

We service what we sell. 10-9 T,
TH, F; 10-5 W, SAT.

Iowa

BOB SMITH ELECTRONICS

RFD #3, HIGHWAY 169 and 7

FT. DODGE, IA 50501

515-576-3886

For an EZ deal.

Kansas

ASSOCIATED RADIO

8012 CONSER P. O. B. 4327

OVERLAND PARK, KS 66204

913-381-5901

Amateur Radio's Top Dealer.

Buy — Sell — Trade

Dealers - You should be here too! Contact Ham Radio today for complete details.

Amateur Radio Dealer

Kentucky

COHOON AMATEUR SUPPLY
HIGHWAY 475
TRENTON, KY 42286
502-886-4535
Yaesu, Ten-Tec, Tempo, DenTron.
Our service is the BEST.

Maryland

COMM CENTER, INC.
9624 FT. MEADE ROAD
LAUREL PLAZA RT. 198
LAUREL, MD 20810
301-792-0600
New & Used Amateur Equipment.
Wilson, Ten-Tec, R. L. Drake, Tempo

**PROFESSIONAL
ELECTRONICS CO., INC.**
1710 JOAN AVENUE
BALTIMORE, MD 21234
301-661-2123
A professional place for amateurs.
Service-sales-design.

Massachusetts

TUFTS RADIO ELECTRONICS
209 MYSTIC AVENUE
MEDFORD, MA 02155
617-395-8280
New England's friendliest
ham store.

Michigan

ELECTRONIC DISTRIBUTORS
1960 PECK STREET
MUSKEGON, MI 49441
616-726-3196
Dealer for all major amateur
radio product lines.

RADIO SUPPLY & ENGINEERING
1207 WEST 14 MILE ROAD
CLAWSON, MI 48017
313-435-5660
10001 Chalmers, Detroit, MI
48213, 313-371-9050.

Minnesota

ELECTRONIC CENTER, INC.
127 THIRD AVENUE NORTH
MINNEAPOLIS, MN 55401
612-371-5240
ECI is still your best buy.

PAL ELECTRONICS INC.
3452 FREMONT AVE. NORTH
MINNEAPOLIS, MN 55412
612-521-4662
The Midwest's Fastest Growing
Ham Dealer.

Missouri

HAM RADIO CENTER, INC.
8340-42 OLIVE BLVD.
ST. LOUIS, MO 63132
800-325-3636
See Our Ads
In This Issue.

MIDCOM ELECTRONICS, INC.
2506 SO. BRENTWOOD BLVD.
ST. LOUIS, MO 63144
314-961-9990
At Midcom you can try before you
buy!

Nebraska

COMMUNICATIONS CENTER, INC.
443 NORTH 48 ST.
LINCOLN, NE 68504
800-228-4097
Kenwood, Yaesu, Drake and more
at discount prices.

New Hampshire

EVANS RADIO, INC.
BOX 893, RT. 3A BOW JUNCTION
CONCORD, NH 03301
603-224-9961
Icom, DenTron & Yaesu dealer.
We service what we sell.

New Jersey

ATKINSON & SMITH, INC.
17 LEWIS ST.
EATONTOWN, NJ 07724
201-542-2447
Ham supplies since "55".

RADIOS UNLIMITED
1760 EASTON AVENUE
SOMERSET, NJ 08873
201-469-4599
New Jersey's newest
complete Amateur Radio center

THE BARGAIN BROTHERS
216 SCOTCH ROAD
GLEN ROC SHOPPING CTR.
WEST TRENTON, NJ 06828
609-883-2050
A million parts - lowest prices
anywhere. Call us!

New Mexico

ELECTRONIC MODULE
601 N. TURNER
HOBBS, NM 88240
505-397-3012
Yaesu, Kenwood, Swan, DenTron,
Tempo, Atlas, Wilson, Cushcraft

New York

ADIRONDACK RADIO SUPPLY, INC.
185 W. MAIN STREET
AMSTERDAM, NY 12010
518-842-8350
Yaesu dealer for the Northeast.

GRAND CENTRAL RADIO
124 EAST 44 STREET
NEW YORK, NY 10017
212-682-3869
Drake, Atlas, Ten-Tec, Midland,
Hy-Gain, Mosley in stock

RADIO WORLD
ONEIDA COUNTY AIRPORT
TERMINAL BLDG.
ORISKANY, NY 13424
315-337-2622
New & Used ham equipment.
See Warren K2IXN or Bob WA2MSH.

Ohio

**AMATEUR RADIO
SALES & SERVICE INC.**
2187 E. LIVINGSTON AVE.
COLUMBUS, OH 43209
614-236-1625
Antennas for all services.

UNIVERSAL AMATEUR RADIO, INC.
1280 AIDA DRIVE
REYNOLDSBURG, (COLUMBUS) OH
43068
614-866-HAMS
Drake, Yaesu, Ten-Tec, KDK, Wilson,
DenTron, Tempo, Sigma.

Oklahoma

RADIO STORE, INC.
2102 SOUTHWEST 59th ST.
(AT 59th & S. PENNSYLVANIA)
OKLAHOMA CITY, OK 73119
405-682-2929
New and used equipment —
parts and supply.

Oregon

PORTLAND RADIO SUPPLY CO.
1234 S.W. STARK STREET
PORTLAND, OREGON 97205
503-228-8647
Second location, 1133 S. Riverside
Avenue, Medford, OR 97501.

Pennsylvania

ARTCO ELECTRONICS
302 WYOMING AVENUE
KINGSTON, PA 18704
717-288-8585
The largest variety of semiconduc-
tors in Northeastern Pennsylvania

HAM MART

ELECTRONIC EXCHANGE
136 N. MAIN STREET
SOUDERTON, PA 18964
215-723-1200

New & Used Amateur Radio
sales and service.

"HAM" BUERGER, INC.
68 N. YORK ROAD
WILLOW GROVE, PA 19090
215-659-5900

Communications specialists.
Sales and service.

**HAMTRONICS, DIV. OF
TREVISE ELECT.**
4033 BROWNSVILLE ROAD
TREVISE, PA 19047
215-357-1400

Same location for 25 years.

Tennessee

GERMANTOWN AMATEUR SUPPLY
3203 SUMMER AVE.
MEMPHIS, TN 38112
800-238-6168
No monkey business. Call
Toll Free.

Texas

AGL ELECTRONICS
3068 FOREST LANE, SUITE 309
DALLAS, TX 75234
214-241-6414 (within Texas)
Out-of-State, Call our toll-free
number 800-527-7418.

HARDIN ELECTRONICS
5635 E. ROSEDALE
FT. WORTH, TX 76112
817-461-9761
Your Full Line Authorized
Yaesu Dealer.

Wisconsin

**AMATEUR
ELECTRONIC SUPPLY, INC.**
4828 WEST FOND du LAC AVENUE
MILWAUKEE, WI 53216
414-444-4200
Open Mon & Fri 9-9, Tues, Wed,
Thurs, 9-5:30, Sat, 9-3.

Washington

AMATEUR RADIO SUPPLY CO.
6213 13TH AVENUE SOUTH
SEATTLE, WA 98108
206-767-3222
First in Ham Radio in Washington
Northwest Bird Distributor

Wyoming

DENCO COMMUNICATIONS CENTER
1728 EAST 2nd STREET
CASPER, WY 82601
307-234-9197
Sales, Service to Wyoming
and the Northern Rockies.

This is easy-
anyone can solder-
WITH
KESTER SOLDER

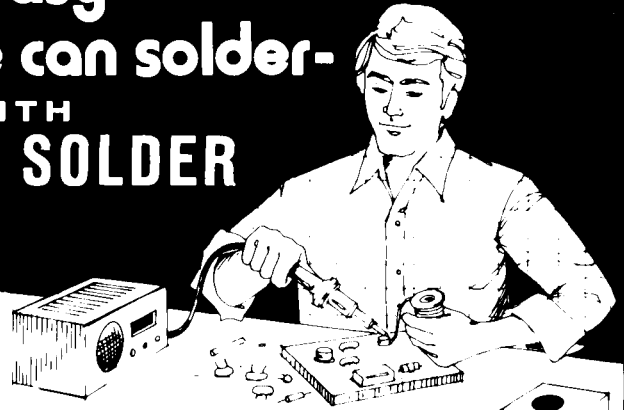

**Handymen! Hobbyists!
DO-IT-YOURSELFERS!**

Let Kester Solder aid you in your home repairs or hobbies. For that household item that needs repairing — a radio, TV, model train, jewelry, appliances, minor electrical repairs, plumbing, etc. — Save money — repair it yourself. Soldering with Kester is a simple, inexpensive way to permanently join two metals.

When you Solder go "First Class" — use Kester Solder.

For valuable soldering information send self-addressed stamped envelope to Kester for a FREE Copy of "Soldering Simplified".



KESTER SOLDER
Litton 4201 WRIGHTWOOD AVENUE/CHICAGO, ILLINOIS 60639

RF ENGINEER

An immediate opportunity exists with our well-established,
growing electronics firm, located in beautiful San Diego.

Requires a BSEE with a minimum of 5 years experience in HF, VHF, and UHF RF design. Candidates must be comfortable with independent state-of-the-art transceiver design and PLL servo theory. Licensed amateur operator desired.

Our offer includes excellent salary and a full range of company sponsored benefits.

CALL WILL GORDON (714) 277-6780, Ext. 245

or send resume to:

SWAN ELECTRONICS
A Division of Cubic Corporation
9233 Balboa Ave., San Diego, Ca., 92123

An Equal Opportunity Employer

CFP COMMUNICATIONS, INC.

THE BEST of BOTH WORLDS

DRAKE

Open Tuesday-Friday 10-6; Saturday 12-4

211 NORTH MAIN STREET
HORSEHEADS, N. Y. 14845

PHONE: 607-739-0187

YAESU

SLEP ELECTRONICS SHIPPING ANTENNAS AND ACCESSORIES

SWAN

TB4HA 4EL 20/15/10 BEAM	259.95
TB3HA 3EL 20/15/10 BEAM	199.95
TB2A 2EL 20/15/10 BEAM	129.95
MB40H 2EL 40 METER BEAM	199.95
1040V 10-40 GOLDEN SWAN TRAP VERTICAL	122.95
75MK ADD 75M TO 1040V	39.95
4010V 10-40 SLIM LINE TRAP VERTICAL	74.95
75AK ADD 75M TO 4010V	39.95
45 MOBILE ANTENNA 75/40/20/15/10, 1000W PEP, GOLD PLATED CONTACTS, MANUAL BAND SWITCHING	119.95
742 MOBILE ANTENNA 75/40/20, 500W PEP, AUTOMATIC SWITCHING	109.95
SWR-1A POWER/SWR METER 0-1 KW, 3.5-150 MHz, SO-239 INLINE	29.95
SWR-3 MEASURE SWR 1:1 TO 3, 1.7-50 MHz SO-239 INLINE	14.95
WM-2000 INLINE WATTMETER 3 SCALES TO 2 KW, POWER/SWR 3.5-30 MHz	64.95
WM-3000 A TRUE PEP SSB INLINE PEAK RMS WATTMETER/SWR TO 2 KW RMS ON PEAK BY SWITCHING	87.95
WM-6200 VHF INLINE WATTMETER/SWR 2 SCALES TO 200 WATT	63.95

MOSLEY

CL-36 CLASSIC 6EL 10/15/20 BEAM	310.00
CL-33 CLASSIC 3EL 10/15/20 BEAM	232.00
TA-33 JR 3EL 10/15/20 BEAM	151.00
TA-33 3EL 10/15/20 BEAM	206.00
TA-40KR CONVERSION KIT ADD 40M TO TA-33	92.00

MINI-PRODUCTS

HQ-1 HYBRID QUAD MINI BEAM, 6, 10, 15, 20M ELEMENT LENGTH 11 FT., BOOM 4-1/2 FT., TURNING RADIUS 6' 2" - 1200W PEP, dB RATIO 12 TO 17 dB. IDEAL BEAM FOR SMALL AREA, WT. 15 LBS.	129.50
---	--------

FINCO

A10-4 BEAM 10M 4EL	57.00
A6-5 BEAM 6M 5EL	41.95
A6-2 BEAM 6 AND 2M COMBO	68.60
A2-10 BEAM 2M 10EL	41.00
A2-5 BEAM 2M 5EL	25.60
A2 + 2 BEAM 10EL DUAL POLARIZATION 2M DESIGNED FOR OSCAR OR SWITCHING FROM VERTICAL TO HORIZ POLARIZATION	41.75

TAYLOR

2M-64TL MOBILE 2 METER 5/8 TRUNK LIP MOUNT	24.95
2M-64RT MOBILE 2M 5/8 ROOF OR DECK MOUNT	24.95
2M-64MM MOBILE 2M 5/8 MAGNETIC MOUNT	24.95
2M-64GC MOBILE 2M 5/8 GUTTER CLIP MOUNT	24.95
2M-1/4 MM MOBILE 2M 1/4 WAVE MAGNETIC MOUNT	12.95

CDR ROTORS

T2X TAIL TWISTER, HEAVY-DUTY WITH CONTROL	245.00
HAM III WITH CONTROL	139.00
CD-44 WITH CONTROL	119.00
8 CONDUCTOR ROTOR CABLE	.18

BARKER & WILLIAMSON

375 — ANTENNA PROTAX SWITCH 6 OUTPUTS SO-239 REAR WITH GROUND FOR LIGHTNING PROTECTION	19.75
376 — SAME AS ABOVE EXCEPT 5 OUTPUTS, AND SIDE SO-239 CONNECTORS	19.75
377 — COAXIAL ANTENNA CHANGE-OVER RELAY, GROUNDS RECEIVER WHEN RELAY IS IN TRANSMIT POSITION, 115V/60 Hz 2KW PEP	19.75

CUSHCRAFT

ATB-34 BEAM 4EL 10/15/20	259.95
ARX-2 RINGO RANGER 135-170 MHz	36.95
ARX-220 RINGO RANGER 220-225 MHz	36.95
ARX-450 RINGO RANGER 435-450 MHz	36.95
DX-120 DX ARRAY 20EL 144-148 MHz	47.95
A147-4 BEAM 4EL 146-148 MHz	22.95
147-11 BEAM 11EL 146-148 MHz	34.95
147-20T TWIST 20EL 144-148 MHz	59.95
A144-10T 10EL OSCAR 145 MHz	39.95
A144-20T 20EL OSCAR 145 MHz	59.95
A432-20T 20EL OSCAR 430-436 MHz	54.95
A14T-MB TWIST MOUNT BOOM AND BRACKET	17.95
A50-5 BEAM 5EL 6 METER	54.95

WE PAY SHIPPING VIA U. P. S. OR BEST WAY ON ALL ADVERTISED ITEMS TO 50 STATES AND TO FPO/APO ON MAILABLE ITEMS. EXPORT SHIPPING EXTRA. WE ACCEPT MASTER CHARGE OR VISA. NORTH CAROLINA RESIDENTS ADD 4% N.C. SALES TAX. PHONE BILL SLEP (704) 524-7519.

SLEP ELECTRONICS

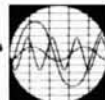

COMPANY

P.O. BOX 100, HWY. 441, DEPT. HR-6
OTTO, NORTH CAROLINA 28763

JAN CRYSTALS HOLD THE FREQUENCY



- CB
- CB standard
- 2 meter
- Scanners
- Amateur Bands
- General Communication
- Industry
- Marine VHF
- Micro processor crystals

easy to charge



Send 10¢ for our latest catalog
Write or phone for more details
2400 Crystal Drive
Ft. Myers, Florida 33901
all phones (813) 936-2397

BEST BUYS

OUR BEST SELLER: ECONORAM II™

S-100 compatible 8Kx8 in a cost-effective package. All lines buffered, fast, low power, unique configuration as two 4K blocks, handles DMA, and many other features... packed on a high quality board and using high quality parts (all sockets included). Totally static design.

See the 1/78 issue of *Kilobaud* for an in-depth evaluation, or send SASE to "KB Reprint" and we'll send you a copy... or better yet, talk to somebody who owns one.

Kit: \$135.00; 3 kits: \$375.00;
Assembled: \$155.00

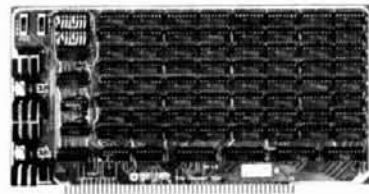

H8 COMPATIBLE ECONORAM VI™ KIT

12Kx8 for the H8, with the same features that have made Econoram the name in S-100 buss memory. Static design, buffering, plus all sockets and bypass caps are already soldered in place so you can get right into the best part of kit building.

Kit form: \$235.00

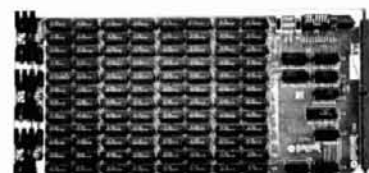

NEW! 16K ECONORAM IV™ KIT

S-100 compatible 16Kx8 memory. Static design, current under 2000 mA, manual write protect switches for 4K blocks, can be used with or without phantom line... and it actually costs less than dynamic equivalents!

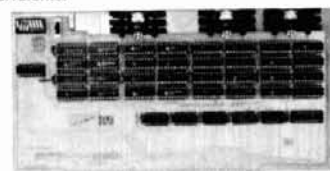

COMING SOON: 24K ECONORAM VII™ KIT

Just around the corner for the S-100 buss... we think you'll like it. All the regular features of our static Econorams, plus... some extras. It's static, it's 24K, it's an Econoram... watch for it!

PLUG FROM BILL: There's more to life than computers... like music. Craig Anderton, noted author and designer of our Musikit products, has produced a cassette tape of original music that is distributed by our friends at PAIA Electronics (1020 W. Wilshire, Oklahoma City, OK 73116, \$6.45 ppd). In addition to hearing our Musikits in action, you get to hear some really good modern music. We like it... you probably will, too.

TERMS: Please allow up to 5% for shipping, excess refunded. Californians add tax. COD orders accepted with street address for UPS. For VISA/Mastercharge orders, call our 24-hour order desk at (415) 562-0636. Prices good through cover month of magazine.

FREE FLYER: These are just a few of the items we carry for the computer enthusiast. We also stock a broad line of semiconductors, passive components, and hobbyist items. We will gladly send you a flyer describing our products upon receipt of your name and address.

GODBOUT

BILL GODBOUT ELECTRONICS
BOX 2355, OAKLAND AIRPORT, CA 94614

Come to Dallas!!

Join thousands of Ham Radio & Computer Enthusiasts gathering for the Southwest's top Ham & Hacker Huddle. With a giant flea market on a paved lot, timely seminars, top trade exhibits, family field trips, ladies' programs, great prizes, and a big barbeque, Ham-Com/78 will be too much to miss.

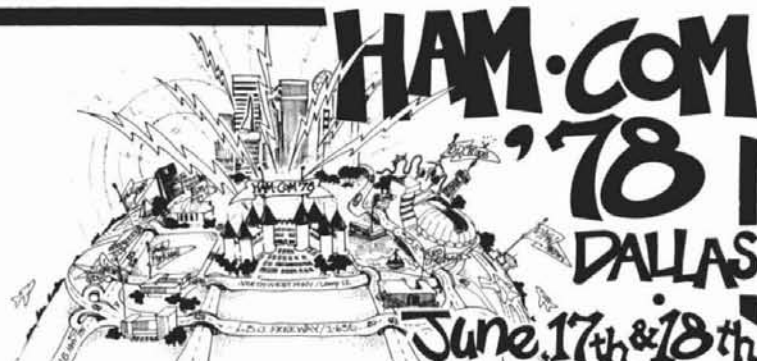

- DUNFEY'S ROYAL COACH INN • 3800 W. NORTHWEST HWY
- FCC Tests All Day • Giant Flea Market
 - Microprocessor Seminar • Antenna Seminar • Ham Radio & the Law • RTTY and Microprocessors • AMSAT Demonstrations
 - Fun Activities for the Whole Family

HAM-COM '78 REGISTRATION: PREREGISTRATION DEADLINE: JUNE 13, 1978

NAME _____
 ADDRESS _____
 CITY _____
 STATE _____ ZIP _____

Ham-Com '78 Registration @ \$5.00 per person for _____ people .. \$ _____
 Bar-B-Que Dinner Saturday Night @ \$10.00 per person for _____ people .. \$ _____
 Ladies Luncheon & Styleshow @ \$5.00 per person for _____ people .. \$ _____
 Flea Market auto registration @ \$3.00 per automobile space (per Call) .. \$ _____
 Flea Market second auto space @ \$8.00 per automobile space (per Call) .. \$ _____
 Double Room for Double Occupancy @ \$16.00 per person for _____ people* Arrival date .. \$ _____
 Single Room for Single Occupancy @ \$25.00 per person for _____ people* Arrival date .. \$ _____

Send check or money order to:

I have enclosed my check or money order for \$ _____

Ham-Com/78, 3321 Towerwood Drive, Suite 101, Dallas, Texas 75234

For Additional Information call (214) 620-2775

PEOPLE WHO KNOW QUALITY AND NEED RELIABILITY

(Military, Industry, RCC's) Demand

Pipo Communications For Trouble Free Touch Tone Encoders



WANT TO KNOW WHY?

Send for Descriptive Brochure and Complete Dealers List
 P.O. Box 3435, Dept. B, Hollywood, CA 90028

Pipo Communications

MILITARY SURPLUS WANTED

Space buys more and pays more. Highest prices ever on U.S. Military surplus, especially on Collins equipment or parts. We pay freight. Call collect now for our high offer 201 440-8787.
 SPACE ELECTRONICS CO.
 div. of Military Electronics Corp.
 35 Ruta Court, S. Hackensack, N.J. 07606

JUNE 3, 4
Atlanta
Dallas
 JUNE 17, 18

We'll see you there!

- HAM RADIO Magazine
- Ham Radio HORIZONS
- HR Report
- Ham Radio's Communications Bookstore

The Ham Radio Publishing Group
 Greenville, NH 03048

Featuring the Competition Grade HF Transceiver

THE NEW YAESU FT-901



CALL OR WRITE
FOR INFORMATION
ON PRICE
AND OPTIONS

FACTORY AUTHORIZED DEALERS FOR:

AEA
ATLAS
B&W
BELDEN
BENCHER
CDE
CUSHCRAFT
DENTRON
DRAKE
FLUKE
HUSTLER
HY GAIN
ICOM
KLM
LARSEN
LUNAR
MFJ
NPC
NYE
ROHN
RF POWER LABS
TEMPO
TEN TEC
WILSON
YAESU - AND MORE

OTHER YAESU MODELS ALSO AVAILABLE

Summer Specials:

(PREPAID SHIPMENT TO AREAS SERVED BY UPS BROWN LABEL)

				Reg.	Sale
CUSHCRAFT	ATB-34	TRI-BAND	BEAM w / BALUN	239.95	199.95
CDE	HAM III	ROTATOR			129.95
CDE	T2X	ROTATOR			249.95
WILSON	SY1	TRI-BAND	BEAM	274.95	239.95

ABOVE SPECIALS EXPIRE JULY 31, 1978 AND ARE SUBJECT TO STOCK ON HAND

MASTER CHARGE & VISA ACCEPTED SAME DAY SHIPMENT ON MOST ITEMS

STORE HOURS: MON. thru SAT. 9:30 a.m. to 6:00 p.m.

C. COMM

6115 - 15th N.W.
SEATTLE, WA. 98107
(206) 784-7337



Oak Hill Academy Amateur Radio Session

19th Year - July 29 thru August 11, 1978

We have moved our location just 15 miles from our previous site to the Oak Hill Academy, Mouth of Wilson, Virginia.

Our accommodations are now the finest one could hope for, suites in a beautiful Dorn with bath for each four students. Lovely spacious lobby and fine recreation room in the lower level of the dorm.

Oak Hill Academy in the Appalachian Mountains of Virginia offers an intensive two week Radio Session in code and theory starting at your level.

Expert instructors, some of whom have been on the staff for the past 18 years are the same. Only the location has been changed. Close association with fellow amateurs offers an opportunity for Saturation Learning that has been very successful since its conception. Novices upgrade to General, Techs to General & Advanced, and Advanced become Extras. Golf privileges, canoeing on the New River & many other recreation activities are offered. Make your vacation a "Vacation with a Purpose" and upgrade your license at a beautiful school in the cool mountains of Virginia.

Formerly Glade Valley School Radio Session

C. L. PETERS, K4DNJ, Director
Oak Hill Academy Amateur Radio Session
Mouth of Wilson, Virginia 24363

Name _____ Call _____
Address _____
City/State/Zip _____

RTTY for ALL Systems



ELECTROCOM® "SERIES 400" FREQUENCY SHIFT CONVERTERS

Professionally engineered for outstanding performance, stability, and reliability, the Electrocom® Models 400 and 402 add new dimensions of compatibility between radio and teletypewriter systems. Manufactured to highest quality standards—an Electrocom tradition for nearly two decades—these units are ideal for military, government, commercial, civil defense and amateur applications. The Model 400 front panel digital knob accurately selects shifts up to 1000 Hz., while two such knobs on the Model 402 independently set the mark and space frequencies. Both models may also be preset with any tone pair between 1000 and 3200 Hz.

Optimum performance with FSK or AFSK

systems is assured by matched filters, precision linear detectors, baud rate selector, bias compensation, and semi-diversity circuitry. Operation is enhanced by a CRT monitor, autostart with solid-state motor switching, antispacer, markhold, EIA/MIL output voltages, and a constant current loop supply. In addition, various options are available including rack mounting and polar current output.

Write or call us for complete product details and specifications. Learn why Electrocom® "400" Converters are designed not only for today's communication environment, but ultimately to fulfill RTTY requirements for years to come.

Electrocom® INDUSTRIES
1105 N. IRONWOOD DRIVE, SOUTH BEND, INDIANA 46615
Telephone: (219) 232-2743

WORK MEXICO in the JUNE VHF CONTEST!

A special expedition to Punta Banda, Baja California, will be active for this contest on the following bands:

- 50 MHz—50.100, or 50.155 calling frequency.
- 144 MHz—144.012 for EME and 144.200 and FM simplex calling.
- 220 MHz—222.005 and FM simplex calling.
- 432-1296 and 2304 MHz upon request.

Station call is XE2BC headed by XE2IO, XE2SI, XE2AZR with an assist from the Lunar gang; Chip N6CA and Louis WB6NMT. For skeds contact Lunar.

LUNAR'S COMPLETE LINE OF AMATEUR EQUIPMENT!

LUNAR'S Linearized Amplifier



1.3M10-70P \$199.95
2M10-80P \$189.95

Lunar's equipment includes Transverters.



\$99.95

LUNAR'S NEW OSCARBOX "J"
"Get on Oscar 8!"



\$49.95

LUNAR'S in Line RF Actuated Preamp



C. W. KEYBOARD MODULE

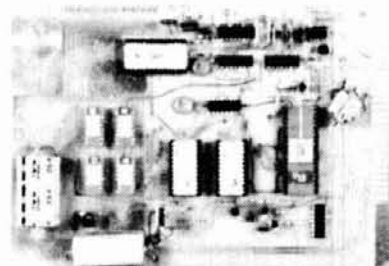

BY WB2DFA. SEE JAN '78 HR, PGS 81-87

- DOUBLE SIDED, PLATED THRU BOARD
- USES POWERFUL 6504 MICROPROCESSOR
- 256 CHARACTER BUFFER • 64 CHARACTER RECALLABLE BUFFER FOR CQ's, HERE IS . . . ETC. • 5 TO 99 W.P.M. SPEED RANGE • XTAL CONTROLLED • EXPANDABLE MORSE CHARACTER SET • AUTO XMT SWITCH OUTPUT FOR YOUR RIG (KEYBOARD VOX!) • BUFFER OVERFLOW WARNING LAMP DRIVERS • USE WITH ASCII ENCODED KEYBOARD • \$25.00 BARE BOARD LESS PARTS, PPD USA • KITS AVAILABLE •••

PYRAMID DATA SYSTEMS
6 TERRACE AVE., NEW EGYPT, NJ • 609-758-7487

FREE BACK ISSUE CATALOG

Get yours now! Ham Radio's FREE back issue catalog will help you find that special article, complete your series, replace lost issues and discover new ones. Check your magazine library to see what you're missing and send now for your FREE back issue catalog to:

HAM RADIO Magazine
Greenville, NH 03048



FACSIMILE

COPY SATELLITE PHOTOS, WEATHER MAPS, PRESS!

The Fax Are Clear — on our full size (18-1/2" wide) recorders. These commercial-military units now available at surplus prices. Learn how to copy with our FREE Fax Guide. Tel.: (212) 372-0349

ATLANTIC SURPLUS SALES
3730 NAUTILUS BROOKLYN, N.Y. 11224

BUILD YOUR OWN TV CAMERA!

Ideal for home & business



GREAT FOR AMATEUR TV, INDUSTRIAL SURVEILLANCE, HOME ENTERTAINMENT & MONITORING PLUS HUNDREDS OF OTHER USES. MODEL XT-1A SERIES 0 — KIT \$185. FACTORY ASSEMBLED \$268. SOLID STATE. CONNECTS TO ANY TV SET. OPTIONAL SOUND KIT \$28.95. PHONE OR WRITE FOR FREE CATALOG. DIAL 492-9873/7711.

1301 BROADWAY, N.W. **ATV Research** DAKOTA CITY, NEBR. 68731

NEW!

600 MHz Mini Counter

NOW . . .

- Completely PORTABLE with Ni-Cad Batteries
- Crystal Oven Available

7208 COUNTER

DAVIS ELECTRONICS

Pre-Amp PROBE 10-500 MHz Only \$49.95

General Purpose Low Cost Counter Without the Sacrifice of Basic Performance
"Check the features we have that some other low cost counters don't have."

• All Metal Cabinet	• Sensitivity 10 MV at 60 MHz	• Completely Auto Decimal Point
• 8 Digit 4" LED Display	• 115V or 12V Operation	• Selectable Gate Times (1 sec. & .1 sec.)
• Input Cable Included	• Push Button Controls	• Built-in Preamp (optional)
• 12V Input Jack	• Gate Light	• Crystal Time Base (1 ppm after cal.)

7208K 600 MHz Kit . . . \$149.95 7208A Assembled . . . \$199.95

OPTIONS

01) Portable w/Ni-Cad Battery (Built-in Charger) \$39.95
02) Crystal Oven (1 ppm 0 to 60°C)	\$39.95 03) Handle . . . \$5.00
04) Built-in Preamp 10 MV @ 150 MHz \$10.00

DAVIS ELECTRONICS 636 Sheridan Dr., Tonawanda, NY 14150 716/874-5848

TEST EQUIPMENT

All equipment listed is operational and unconditionally guaranteed. Money back if not satisfied. Prices listed are FOB Monroe.

HP120B 450kHz gen pur scope	\$215
HP160B (USM105) 15MHz scope with reg horiz, dual trace vert plugs	375
HP166B (Mil) Delay sweep for above	130
HP170A (USM140) 30MHz scope with reg horiz, dual trace vert plugs	475
HP175A 50MHz scope with reg horiz, dual trace vert plugs	565
Tek565 Dual beam 10MHz scope less plug ins (3 series)	625
Tek585 80MHz gen pur scope less plugin	645

For complete list of all test equipment send stamped, self addressed envelope.

GRAY Electronics

P.O. Box 941, Monroe, Mich. 48161
Specializing in used test equipment.

REPEATER USERS — Stay in Touch — with DSI

UNIVERSAL

The Data Signal TTP Series of keyboard encoders is used to generate the standard 12 or 16 DTMF digits. The encoders provide fully automatic transmitter keying and feature a delayed **Transmit Ready** light, an interdigit timer, and a built-in **audio monitor**. Features also include all solid-state, crystal-controlled, digitally-synthesized tones and an optional internal mount Automatic Number Identifier (ANI).

TTP-1 (12-digit)

\$59.00

TTP-2 (16-digit)

\$69.00

MODEL DTM — Completely self-contained miniature encoder for hand-held portables. Only 5/16" thick. Three wire connection. Automatic PTT keying optional. With your choice of keyboards. Price **DTM** - \$39.00, **DTM-PTT** - \$49.00.

*Touch-Tone is a registered trade name of AT&T.

TOUCH-TONE®

ENCODERS

TTP-1



DTM



TTP-2



SUB-MINIATURE ENCODERS



MODEL SME — Smallest available Touch Tone Encoder. Thin, only .05" thick, keyboard mounts directly to front of hand-held portable, while sub-miniature tone module fits inside. This keyboard allows use of battery chargers. Price \$29.00, with your choice of keyboards. **SME** (less keyboard) \$24.00

AUTOPATCH — Ready to go!



A Complete Autopatch facility that requires only a repeater and a telephone line. Features include single-digit access/disconnect, direct dialing from mobile or hand-held radios, adjustable amplifiers for transmitter and telephone audio, and tone-burst transponder for acknowledgement of patch disconnect.

RAP-200 P. C. Card
RAP-200R Rack Mount

\$199.50
\$249.50

DATA SIGNAL, INC.

2403 COMMERCE LANE
ALBANY, GEORGIA 31707, 912-883-4703



Be sure to ask about
our new keyers and CW
memory for CW buffs.

YOU'VE SEEN THE MAGAZINE ARTICLES

Here's what you can expect
from the **DX ENGINEERING**
RF Speech Processor

- 6 db INCREASE IN AVERAGE POWER
- MAINTAINS VOICE QUALITY
- IMPROVES INTELLIGIBILITY
- NO CABLES OR BENCH SPACE REQUIRED
- EXCELLENT FOR PHONE PATCH
- NO ADDITIONAL ADJUSTMENTS — MIKE GAIN ADJUSTS CLIPPING LEVEL
- UNIQUE PLUG-IN UNIT — NO MODIFICATIONS REQUIRED



This is RF Envelope Clipping—the feature being used in new transmitter designs for amateur and military use.

Models Now Available
Collins 32S, KWM-2 \$ 98.50 ea.
Drake TR-3, TR-4, TR-6, TR-4C.
T-4, T-4X, T-4XB, T-4XC \$128.50 ea.
Postpaid — Calif. Residents
add 6% Tax

Watch for other models later!

DX Engineering

1050 East Walnut, Pasadena, Calif. 91106

FREE!

NEW '78 AMATEUR RADIO CATALOG

Choose from the
top names in
selected ham
equipment.
Plus—get the
full details on
Clegg's unique
purchase plans for
Drake/Yaesu/
KLM/Dentron/Alpha/Microwave
modules/Atlas and other quality
products.

Phone toll-free today for your new Clegg catalog!

1-800-233-0250

In Pennsylvania call collect
717-299-7221.

Clegg Communications Corp., 1911
Old Homestead Lane, Greenfield
Industrial Park East,
Lancaster, PA 17601.

Clegg

1978 CATALOG
FOR THE RADIO AMATEUR
INCLUDING:

ALPHA LINE AMATEUR EQUIPMENT
ATLAS TRANSMITTERS AND ACCESSORIES
CLEGG TRANSMITTERS AND ACCESSORIES
COLLINS TRANSMITTERS AND ACCESSORIES
CRACKER JARVIS REPEATER AND ACCESSORIES
DRYDEN TRANSMITTERS AND ACCESSORIES
KLM/DENTRON TRANSMITTERS AND ACCESSORIES
MICROWAVE AMATEUR EQUIPMENT
MOBILE AMATEUR TRANSMITTERS AND ACCESSORIES
YAESU TRANSMITTERS AND ACCESSORIES



Clegg

FOR FASTER SERVICE!



- Crystal controlled highly accurate & stable.
- Two output lines; high impedance and low impedance.
- Adjustable level control, both outputs.
- Low distortion sine wave output.
- Completely encapsulated for physical ruggedness.
- Reverse polarity protection.
- Transient voltage protection.
- 8-16 volt operation.
- High RF immunity.
- 100 Hz standard, other frequencies available on request.
- Parts & workmanship fully warranted for 2 years, when operated within specifications.
- Mounting cushion provided.

The all new AR model M100 PL unit, unlike the other type, insures against physical damage and inadvertent short-circuits because of its complete encapsulation in resilient epoxy. Furthermore, the M100 PL uniquely offers your choice of high and low impedance outputs to facilitate finding a suitable injection point. Should for any reason other than physical abuse the M100 PL unit fail within 2 years, AR will replace it on an exchange basis for only \$6.50 handling, freight, and insurance charges.

Dedicated to Excellence
AR Technical Products Corp.
 Box 62 Birmingham, MI 48010 Phone (313) 588-2288

32⁹⁵ Shipping & Insurance included

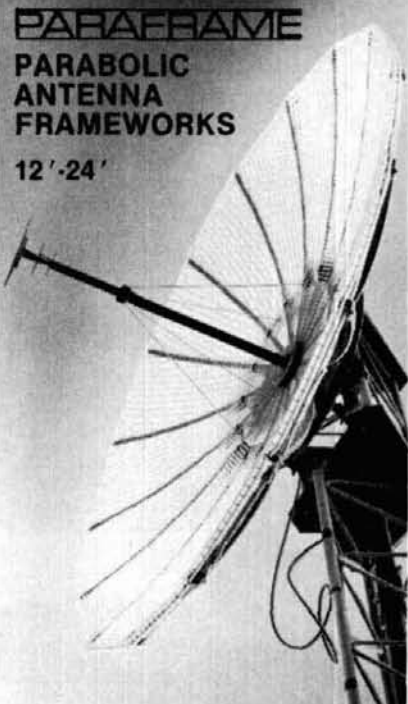

PARAFAME
PARABOLIC
ANTENNA
FRAMEWORKS
 12'-24'

NEW BROCHURE \$2. USA, CANADA
\$3. ELSEWHERE
JAMES K. VINES
 611 Farmview Rd.
 Park Forest South, IL
 60466

PARTS !!

AIR VARIABLE CAPACITORS

40-310pf Dual, 7.5KV	\$27.00
27-300pf Dual, 4.5KV	\$25.00
40-310pf Single, 7.5KV	\$17.50
27-300pf Single, 4.5KV	\$16.75
40-190pf Single, 5.5KV	\$16.25

Many, Many More Types. Send SASE for free list.

JUNE - JULY SPECIALS "While They Last"

TUBES-- Many types in stock

6JS6C	\$5.50	6146A	\$6.25
572B	\$29.00	6146B	\$6.75

EIMAC POWER TUBES IN STOCK
 Send SASE for free list of tubes.

AMPHENOL CONNECTORS

PL259(UHF)	79¢
UG21B/J(N)	\$1.99
UG88/U(BNC)	99¢

WILSON WR500 ROTOR -- \$89.95
 ROTOR CABLE--15¢ per ft(8conductor)
 MUFFIN FANS - \$7.50 ea.

TELETYPE PAPER/TAPE--\$10.00/case

USED EQUIPMENT

R390	\$375.00	R390A	\$395.00
------	----------	-------	----------

Send SASE for used equipment list.

Please allow for shipping charges.
 AZ residents add 5% sales tax.

Amateur Radio Center
 11 S. Morris, Mesa, AZ 85202

(602)833-8051

WANTED FOR CASH

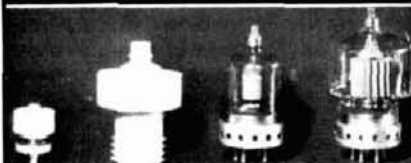

4CX150	4CX1000	4-65	4-250
4CX250	4CX1500	4-125A	4-400
4CX300A	4CX3000		4-1000
4CX350A	4CX5000		304TL
	4CX10,000		
	5CX1500		

Other tubes and Klystrons also wanted.
 See last month for other items available.

The Ted Dames Company

308 Hickory St. Arlington, N.J. 07032
 (201) 998-4246 Evenings (201) 998-6475

NEW ELECTRONIC PARTS
 IC'S - TRANSISTORS - PROTOBOARDS - RESISTORS
 CAPACITORS - DIODES - SWITCHES - CONNECTORS
 VOLTAGE REGULATORS - CABINETS - HEAT SINKS
 FUSES & MUCH MORE--STAMP BRINGS CATALOG

SPECIALS KEYBOARD ENCLOSURES

TWO SIZES	W	D	H	PRICE
	14	8.3	3	\$15.20*
	14	11.3	3	\$16.50*

BLUE BASE SPECIFY
 WHITE OR BLACK TOP

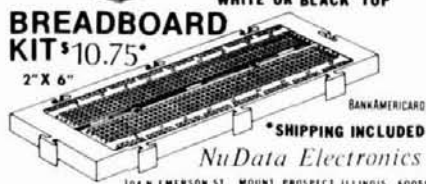

MOVING? KEEP HAM RADIO COMING ...

If possible let us know four to six weeks before you move and we will make sure your HAM RADIO Magazine arrives on schedule. Just remove the mailing label from this magazine and affix below. Then complete your new address (or any other corrections) in the space provided and we'll take care of the rest.

ham radio
 Magazine

Allow 4-6 weeks for correction.

Greenville, NH 03048

Thanks for helping us to serve you better.

Here's my new address:

Call _____
 Name _____
 Address _____
 City _____ State _____ Zip _____

AFFIX LABEL HERE

COLLINS & MORE

Ham Gear

Collins 180S1, Antenna tuner	\$325
Collins 51J4 w/SSB Mod, like new	\$695
Collins 312B4, Sta. Cntl., rd., exc.	\$250
Collins 312B5, Vfo Console, vy gd	\$495
Collins 312B5, Vfo Console, new, orig. box	\$795
Collins 32S3, Transmitter, rnd., exc.	\$850
Collins 75S3, Ham receiver, vy gd	\$425
Collins 75S3B, Ham receiver, vy gd	\$695
Collins 75A4, Ham receiver, vy gd	\$425
Collins 51S1, 2-30MHz rcvr	Special \$425
Collins R-388/51J3 receiver, vy gd	Special \$425
Hammarlund SP-600JX, .5-50MHz rcvr	\$395
Collins CP-1 Crystal Pack	\$195

FREDERICKS:

Model 1200 FSK demodulator exc.	\$495
Model 1250 vert. disp. unit, exc.	\$475
Model 1500 HF receiver, exc.	\$795
Model 1550 synthesizer, exc.	\$895

Racal 6217E, .5-30MHz receiver Special
New R390A receivers available. Call for quote.

Test Gear

Tektronix 422 portable scope, vy gd	\$795
Tektronix 564 storage scope w/2 plug-ins & probes, vy gd	\$695
Blue M temp. cont. water bath SPB-103 C1, new	\$250
Measurements Mod. 65B, LF sig. gen.	\$365
Measurements 260A Q-meter, exc.	\$525
Measurements Model 80, 2-400 MHz sig. gen.	\$350
Tektronix 585A, scope, 80-MHz bandwidth	\$595

We stock good, used equipment from Collins, Drake, Heath and other manufacturers. Hundreds of test items also available. Call for specific requirements, or

write for free catalog.

DAMES COMMUNICATION SYSTEMS

201-998-4256

10 SCHUYLER AVENUE

NORTH ARLINGTON, N. J. 07032

All equipment sold checked and realigned

Get the most from your antenna!



With the Omega-t Antenna Noise Bridge you can test for resonant frequency and impedance... adjust and retest... until your antenna performs at its optimum. Use the Noise Bridge to trim RF lines for best performance, too.

This patented design uses your sensitive receiver as a bridge detector, outperforming more expensive test equipments.

Reduce power loss due to mismatch — now! Get more details or order today.

Model TE7-01... 1-100 MHz range: \$34.95

Model TE7-02... 1-300 MHz range: \$44.95

ESI ELECTROSPACE SYSTEMS, INC.

P.O. BOX 1359

RICHARDSON, TEXAS 75080

TELEPHONE (214) 231-9303

Sold at Amateur Radio Dealers or Direct from ElectroSpace Systems, Inc.

6 NEW ONES!

THE HANDBOOK OF SOLAR FLARE MONITORING & PROPAGATION FORECASTING

by Carl M. Chernan, WA3UER

T-1005 An excellent do-it-yourself guide to building and operating a solar flare detection station for serious Radio Amateurs, shortwave listeners and communications experimenters.

Learn to build (or how to inexpensively acquire) and use the antennas, receivers and recorders needed to monitor and record the fascinating solar flare.

Just \$6.95

HOME-BREW HF/VHF ANTENNA HANDBOOK

by William Hood, W2FEZ

T-963 A brand new do-it-yourself antenna book primarily designed for someone with a working knowledge of antennas, although the first chapter offers excellent basic reference information. Transmission lines, couplers, filters, mobile antennas, compact antennas, directive, and many more. A practical, usable book sure to get lots of use.

Only \$5.95

THE ZAPPING OF AMERICA

by Paul Brodeur

NZ-A "Zapping" attempts to expose the dangers of radio waves and microwaves which are beamed into our environment by a multitude of electronics devices — devices like your own radio equipment. In this much-researched volume, the author describes this "invisible assault" and delivers his hard-hitting message advocating microwave controls. This is a book every Radio Amateur should read and begin to form his own opinion.

Hardbound \$11.95

AMATEUR TV IN A NUTSHELL

by Henry Ruh, WB9WWM

R-ATV Subtitled "Everything You Need to Know to Build and Operate Your Own HAM-TV Station", this brand new book gives you the most complete information now available on this exciting facet of our hobby. Both beginners and more experienced ATV operators will find this authoritative book a valuable resource. Just published! Now \$5.00

QSO CODE PRACTICE TAPE

QSO-T and **QSO-T1** A NEW tape and a NEW method! This cassette tape simulates actual QSO's and will help give you the jump on the new FCC exams. Answer key included. Just introduced is a speedy 20, 23, and 26 wpm (QSO-T1) cassette. Also available 7½, 10, 13, 15 wpm (QSO-T) one-hour cassette \$4.95 ea.

TEST EQUIPMENT FOR THE RADIO AMATEUR

by H. L. Gibson, G2BUP

RS-TRA This is the new, enlarged edition of an extremely useful RSGB publication describing test equipment, its use and construction techniques. New chapters discuss wavemeters and power supplies; all other chapters have been completely updated to make this the finest book of its kind available anywhere. Hardbound \$9.50

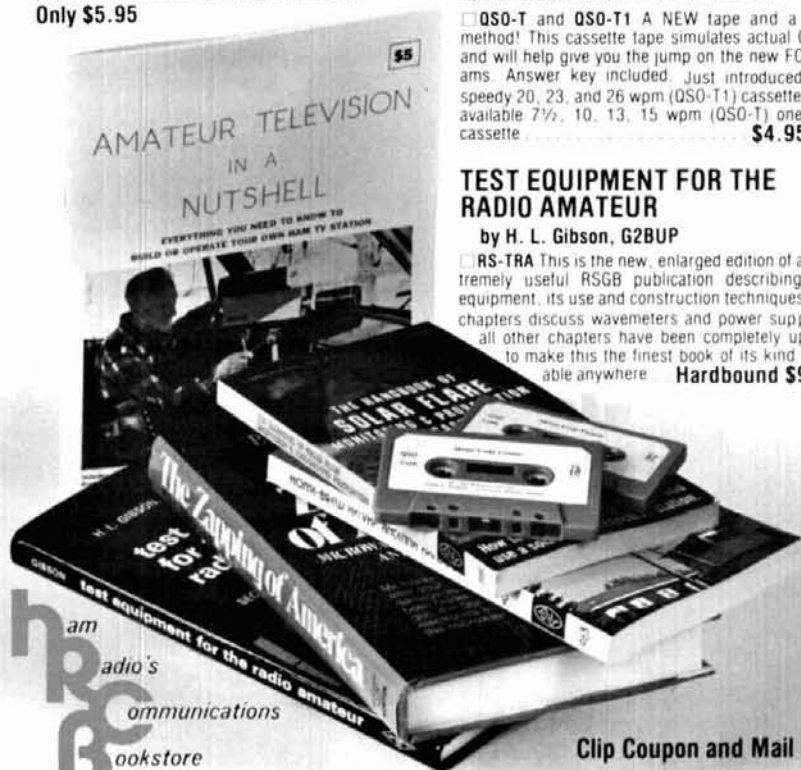

Clip Coupon and Mail Now!

Check below to order:

- T-1005 The Handbook of Solar Flare \$6.95
- T-963 Home-Brew HF/VHF Antenna \$5.95
- RS-TRA Test Equipment for the Radio Amateur \$9.50
- NZ-A The Zapping of America \$11.95
- R-ATV Amateur TV in a Nutshell \$5.00
- QSO-T 7½, 10, 13, 15 wpm tape \$4.95
- QSO-T1 20, 23, 26 wpm tape \$4.95

Total Book Cost _____

Total Postage _____

(Add 35 ea. for 1-3 books, 4 or more HRCB pays postage.)

Final Total

Check or Money Enclosed

VISA Master Charge

Acct. # _____

Exp. date _____ MC Bank # _____

Call _____

Can't wait? Call TOLL FREE
800-258-5353

Name _____

Address _____

City _____ State _____ Zip _____

Advertisers check-off

...for literature, in a hurry — we'll rush your name to the companies whose names you "check-off"

Place your check mark in the space between name and number. Ex: Ham Radio 234

INDEX

AR Tech. 687	Icom 065
AGL 558	Integ. Circuits 518
ALDA 625	Int. Crystal 066
ATV *	Jameco 333
Adv. Elect.	Jan 067
Appl. 677	Jones 626
Aluma 589	K. Enterprises 071
Antenna, Inc. 686	Kengore 538
Atlantic Surplus 644	Kenwood *
Atlas 198	Kester *
Bauman 017	Lafayette 598
Budwig 233	Long's 468
Bullet 328	Lunar 577
Bunker Ramo 517	Lyle 373
Burbank 669	MFJ 082
C-Comm 688	Madison *
CFP 022	NuData 455
CW Elec. 533	Oak Hill Ac. Am. Radio
Clegg 027	Sess. 213
Communications	Optoelectronics 352
Center 534	Palomar Eng. 093
Comm. Spec. 330	Partridge 439
Cont. Spec. 348	Pipo 481
Crystal Banking 573	Prime Comp. 627
Cushcraft 035	P.C.P. 648
DGM 458	Pyramid 678
DSI 656	QSA 599 638
DX Eng. 222	RF Power Labs 602
Dames Comm. 561	R.I.W. 679
Dames, Ted 324	Callbook 100
Data Signal 270	Radio Sys. Tech. 422
Davis Elect. 332	Radio World *
DenTron 259	Ramsey 442
Disc-Cap 449	Regency 102
Drake 039	Rohn 410
E. T. O. *	SST 375
Electrocom 663	Sherwood 435
Elect. Distr. 044	Slep 232
Elect. Equip.	Space 107
Bank 288	Spectronics 191
Elect. Signal 670	Spectrum Int. 108
Electrospace 407	Swan 111
Erickson 047	TPL 240
Essary Ent. *	T/T Comm. 690
Fair Radio 048	Tandy Comp. 165
Fox-Tango 657	Ten-Tec *
GLB 552	Texas Towers 681
Godbout 647	The Comm. Center 634
Gray 055	Tristao 118
Gregory *	Turner 689
Gull 635	VHF Eng. 121
Hal 057	Vanguard *
Hal-Tronix 254	Varian 043
Hallicrafters 632	Vines 614
Ham-Com '78 *	Webster Assoc. 423
Hammond 624	Weinschenker 122
Ham Center 491	Western *
HRCB 150	Whitehouse 378
Hamtronics 246	Wilson Elect. 123
Heath 060	Yaesu 127
Henry 062	

*Please contact this advertiser directly.

Limit 15 inquiries per request.

June 1978

Please use before July 31, 1978

Tear off and mail to

HAM RADIO MAGAZINE — "check off"
Greenville, N. H. 03048

NAME

CALL

STREET

CITY

STATE.....ZIP.....

AGL would like you
to know that
we're now a **YAESU**
dealer with a
big stock of their
latest and best gear!



Have you thought about Yaesu's FT-901D series of competition grade HF transceivers? Take the FT-901DM for example; an all-mode transceiver designed to give you the competitive edge either at home or on a DX-pedition. Look at these features; rejection tuning, variable IF bandwidth tuning, and audio peak frequency tuning; plus digital and analog frequency display, a built-in Curtis 8043 keyer chip, and much, much more! Come in — call — or write TODAY, and make your own dream come true.

AGL also takes great pride in stocking these other great lines of Amateur radio equipment.



**We'll see you in Atlanta
June 3rd and 4th, and in
Dallas June 17th and 18th.**



**CALL US TODAY
TOLL FREE AT
1-800-527-7418**



CALL 214-241-6414 (in Texas)

ART K9TRG

GORDON N5AU

MIKE N5FL

MIKE N5MP

TOM K5TM

BOB W5XC

**We service and repair all major lines of
Amateur Radio equipment.**



**3068 FOREST LANE, SUITE 309
DALLAS, TEXAS 75234**

Advertisers iNdex

AR Technical Products, Inc.	116, 140
AGL Electronics	142
ALDA Communications	86
ATV Research	138
Advanced Electronic Application	109
Aluma Tower Co.	131
Atlantic Surplus Sales	138
Atlas Radio	66, 67
R. H. Bauman Sales Co.	112
Budwig Mfg. Co.	106
Bullet	131
Burbank Electronics	126
C-Comm	137
CFP Communications	134
CW Electronic Sales Company	35
Clegg	139
Communications Center	129
Communications Specialists	50, 51
Continental Specialties	101
Crystal Banking Service	120
Cushcraft	46, 47
DGM Electronics	126
DSI Instruments	119
DX Engineering	139
Dames Communications Systems	141
Dames, Ted	140
Data Signal, Inc.	139
Davis Electronics	130, 138
DenTron Radio Company	7
Disc-Cap	83
Drake Co., R. L.	78, 79, 80, 108
Drake Co.	104
Ehrhorn Technological Operations	143
Electrocom Industries	137
Electronic Distributors	110
Electronic Equipment Bank	118
Electronic Signal Products	128
Electrospace Systems	141
Erickson Communications	120
Essary Enterprises	124
Fair Radio Sales	112
Fox-Tango Corporation	93
GLB	130
Godbout Electronics	135
Gray Electronics	138
Gregory Electronics	114
Gull Electronics	117
Hal Communications Corp.	19
Hal-Tronix	85
Ham-Com '78	136
Ham Radio Center	130
Ham Radio's Communications Bookstore	140, 141
Hamtronics, Inc.	121
Heath Company	25
Henry Radio Stores	Cover II
Icom	5
Integrated Circuits Unlimited	123
International Crystal	77
Jameco Electronics	127
Jan Crystals	135
Jones, Marlin P. & Assoc.	128
K. Enterprises	106
Kengore Corp.	128
Trio-Kenwood Communications, Inc.	8, 9, 72, 73
Kester Solder	134
Lafayette Radio Electronics	108
Long's Electronics	144
Lunar Electronics	138
Lyle Products	118
MFJ Enterprises	2, 110
Madison Electronic Supply	91, 124
NuData Electronics	140
Oak Hill Academy Amateur Radio Session	137
Optoelectronics	95
Palomar Engineers	105, 122
Partridge (HR) Electronics	120
Pipo Communications	136
Printed Circuit Products	112
Pyramid Data	138
QSA 599 Amateur Radio Center	140
RF Power Labs	106
R.I.W. Products	126
Radio Amateur Callbook	126, 131
Radio Systems Technology, Inc.	118
Radio World	122
Ramsey Electronics	65
Regency Electronics	107
Unarco-Rohn	112
SST Electronics	125
Sherwood Engineering	112
Slep Electronics	135
Space Electronics	136
Spectronics	103
Spectrum International	114
Swan Electronics	111, 113, 115, 134
TPL Communications	114
T/T Communications	116
Tandy Computers	105
Ten-Tec	39
Texas Towers	120
The Comm Center	116
Tristao Tower	124
VHF Engineering, Div. of Brownian	43
Vanguard Labs	124
Varian, Eimac Division	Cover IV
Vines, James K.	140
Webster Associates	122
Weinschenker	122
Western Electronics	106
Whitehouse, G. R. & Co.	118
Wilson Electronics	1
Yaesu Electronics Corp.	Cover III

THE ALPHA'S ARE COMING!



FOUR RUGGED NEW BEAUTIES . . . EACH IN A CLASS BY ITSELF

There are lots of so-called "Maximum Legal Power" linear amplifiers on the market. Why is it that so many knowledgeable amateurs, after checking out (and often owning) the others, ultimately choose an ALPHA?

For one thing, "maximum legal power" doesn't begin to tell the whole story. Nearly all manufacturers' ratings implicitly assume an amateur service duty cycle much less than 100%. Even the terms "continuous" and "100%" duty have been so debased in recent years as to be meaningless unless explicitly defined. The consequence, too often, is a power transformer or tube going up in smoke during a long operating period.

Every ALPHA amplifier is unequivocally rated to run a full 1000 watts of continuous, average d-c power input, in any mode, with No Time Limit (NTL). You could leave your ALPHA (ANY ALPHA) all day with a brick on the key, at a kilowatt input (or at 2 KW PEP input, two-tone SSB) without hurting it. In fact, you could leave it for weeks: last year we ran a standard ALPHA 76 keydown at a kilowatt for 18 days without ill effect. That's ALPHA POWER. To top it off, your new ALPHA is protected by ETO's exclusive 18 MONTH factory warranty — SIX TIMES AS LONG as the industry-standard 90 days! Now that DOES pretty much tell the whole story.

ALPHA/VOMAX: SPEECH PROCESSING IN A CLASS BY ITSELF . . . for "talk power," low distortion, and ease of use, it has no equal.



These new ALPHA's are even better than their famed ALPHA 76/374 Series predecessors . . . Believe it or not!

The pleasure of owning and using a new ALPHA is enhanced by the ruggedly handsome new metal work . . . refined metering and pushbutton control systems . . . improved bandpass circuits in the no-tune-up models. One version combines the great conveniences of no-tune-up operation AND full CW break-in. Another brings ALPHA POWER to 6 meters.

We've retained the robust components and basic circuitry that compiled such an amazing record of freedom from major failures in the ALPHA 76 and '374. Why tamper with success?

We think the new ALPHA's set a standard for style. But the real beauty of every ALPHA linear amplifier is INSIDE the cabinet — where engineering and craftsmanship tell the whole story of ALPHA superiority.

For detailed descriptive literature and fast service on an even-greater new ALPHA, contact your dealer or ETO direct.

ALPHA: Sure you can buy a cheaper linear . . .
But is that REALLY what you want?

ETO Ehrhorn Technological Operations, Inc.

P.O. Box 708 · Cañon City, Colorado 81212 · (303) 275-1613

DRAKE SUPER BUYS

CALL TOLL FREE! 1-800-633-3410

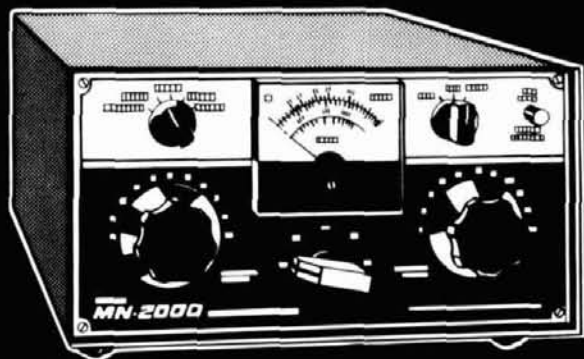
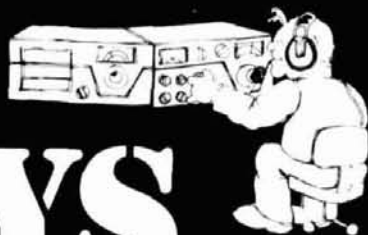

DRAKE TR-4CW transceiver

TR-4CW covers 80 thru 10 meters. Modes SSB, AM, CW • 300 watts PEP input on SSB, 260 watts on CW, AM • 500 Hz CW filter included • Transceiver or separate PTO • Wide range receiving AGC • Constant calibration mode to mode • Solid-state VFO • Shifted-carrier CW • VOX or PTT • Output impedance is adjustable • CW semi-break-in • Audio output: 3 watts • Receiver Incremental Tuning.

799.00 list price. Call Toll-Free for quote.

DRAKE MN-2000 matching network

The MN-2000 is a worthwhile addition to any amateur station where peak performance is desired • Frequency coverage: 3.5 to 4.0 MHz, 7.0 to 7.3 MHz, 14.0 to 14.35 MHz, 21.0 to 21.45 MHz, 28.0 to 29.7 MHz • Input impedance: 50 ohms resistive • Insertion loss: 0.5 dB or less • Wattmeter accuracy $\pm 5\%$ of reading • 1000 watts RF continuous, 2000 W PEP.

250.00 list price. Call Toll-Free for quote.



DRAKE TR-33C 2m transceiver

TR-33C is a mobile 2m FM radio with 12 channel provision (2 supplied) • All FET front-end crystal filter for superb intermod rejection • Ni-Cad cells supplied • Built-in charger • Low power drain circuit on squelched received • Lighted channel dial when using external DC power • Meter indicates receive strength, xmit output, battery voltage.

229.95 list price. Call for quote.

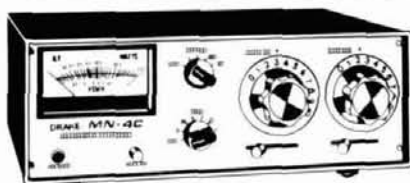

DRAKE MN-4C matching network

New MN-4C features: 160 thru 10 meters coverage • Matches coax FED, long wire, or balanced line antennas with optional 4:1 balun (24.95) • Handles 250 watts continuous RF output • Built-in RF watt meter/VSWR bridge • Unique "low-pass filter" design provides significant harmonic reduction to fight TVI.

165.00 list price. Call for quote.



DRAKE 1525 EM microphone

The auto-patch encoder and microphone are a single unit, fully wired and ready to use • High accuracy IC tone generator, no frequency adjustments • High reliability Digitran® keyboard • Power for tone encoder from transceiver via mic cable • Encoder audio level adjustable from 1mV to 5mV with internal potentiometer • Low output impedance • 4-pin plug.

49.95 Call for yours today.

Remember, you can call TOLL FREE: 1-800-633-3410 in U.S.A. or call 1-800-292-8668 in Alabama for our low price quote. Store hours: 9:00 AM til 5:30 PM, Monday thru Friday.



Long's Electronics



MAIL ORDERS: P.O. BOX 11347 BIRMINGHAM, AL 35202 • STREET ADDRESS: 2808 7TH AVENUE SOUTH BIRMINGHAM, ALABAMA 35233



Years Ahead With Yaesu!

THE ALL-NEW YAESU FT-227R 144-148 MHz 800 CHANNEL

1980's RADIO
TODAY!

“MEMORIZER”!



Compare These Features And You'll Know What We Mean When We Say "Years Ahead With Yaesu"

- one knob channel selection using optical sensing to select 800 channels
- memory circuit that allows instant return to any frequency selected between 144-148 MHz
- large 4 digit LED frequency readout
- fully synthesized frequency control, using PLL techniques in 5 KHz steps
- built-in tone burst, plus optional tone squelch encoder/decoder
- spurious well below minus 60dB requirement—superior cross modulation, overload and image rejection
- standard 600 KHz offsets plus any split within the band using the memory circuit
- automatic final protection, PLL “unlock” protection and busy channel indicator
- selectable 10 watt/1 watt output

See this sensational new two meter transceiver at your YAESU DEALER now!

Yaesu Electronics Corp., 15954 Downey Ave.,
Paramount, CA 90723 ● (213) 633-4007
Eastern Service Ctr., 613 Redna Terrace
Cincinnati, OH 45215

YAESU
The radio.

The first three of a new family of power tubes are available today from EIMAC. These ceramic-metal triodes provide the high power, gain and efficiency of tetrodes, along with long life and reliability up into the UHF spectrum.

EIMAC can supply cavity or cavity design guidance for these tubes in CW as well as pulse service. Because of the circuit simplicity of triodes, this EIMAC family allows the circuit designer to take full ad-

Look at the numbers:

EIMAC Type	Typical CW Performance Data			Maximum Ratings	
	Gain	Power Output	Frequency	Plate Dissipation	Maximum Frequency
3CX400U7	13.5dB	225W	900MHz	400W	1000MHz
3CX600U7	14.0dB	445W	775MHz	600W	1000MHz
8938	12.8dB	1570W	400MHz	1500W	500MHz

vantage of simple cavity design. No tricky screen bypass capacitors or critical isolation circuits are required.

For full information, contact Varian, EIMAC Division, 301 Industrial Way, San Carlos, California 94070. Telephone (415) 592-1221. Or call any of the more than 30 Varian Electron Device Group Sales Offices throughout the world.

EIMAC delivers triode simplicity with tetrode performance at UHF

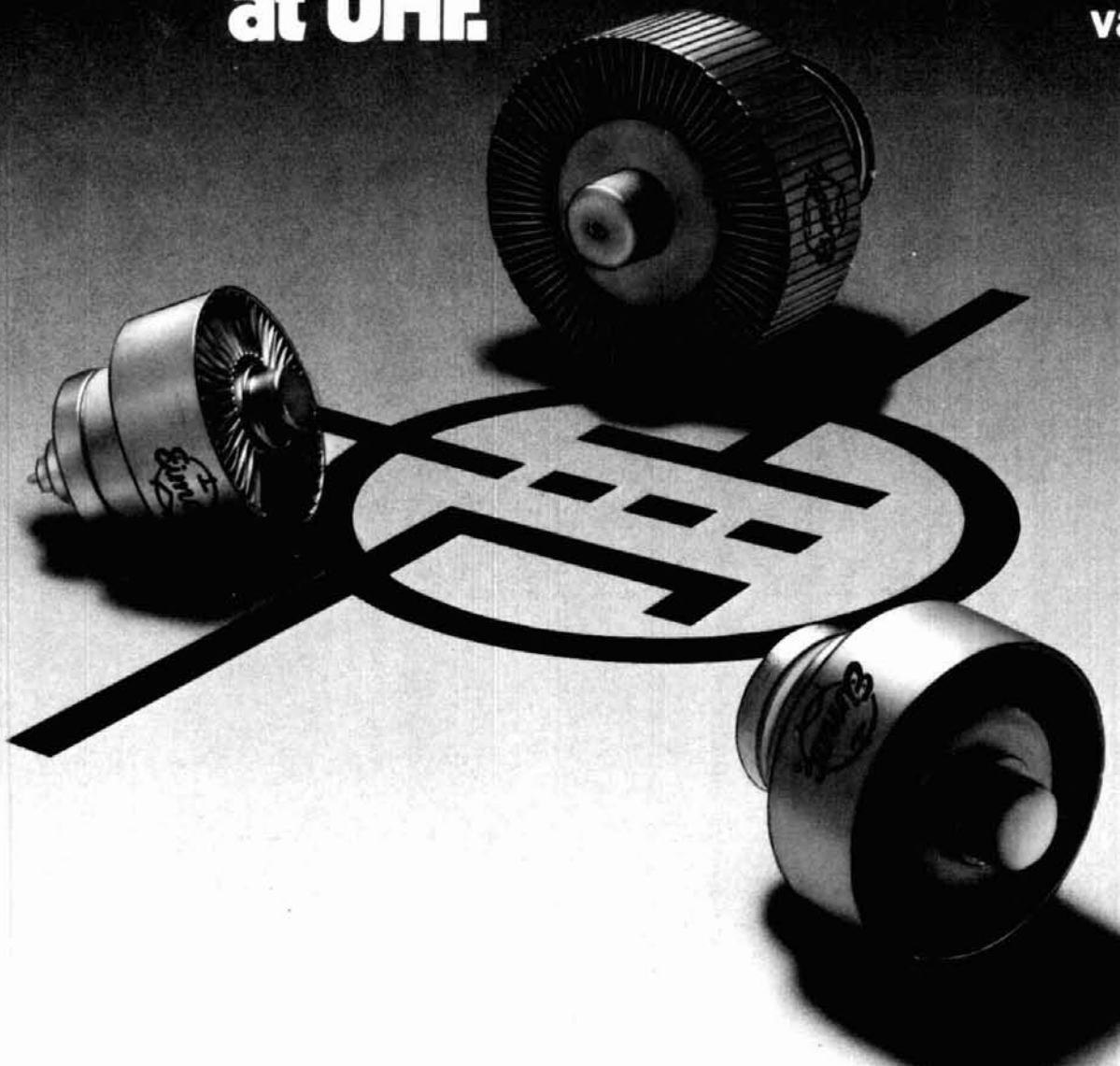

FREE



Send for your copy of the world's largest selection of quality electronic products in easy-to-build, money-saving kit form! Nearly 400 kits in all — all with Heath's world-famous assembly manuals that take you step-by-step from unpacking to final plug-in.

fill in card and mail today

Please rush me my personal copy of the new Heathkit catalog.

I am not on your mailing list.

Name _____

Address _____

City _____ State _____

PC-126 _____ Zip _____

HAM RADIO

Dept. 122-420

HEATH COMPANY
Benton Harbor MI 49022

FREE
HEATHKIT
CATALOG

**PLACE
STAMP
HERE**
The Post Office
will not deliver
mail without postage

Send for your
FREE
HEATHKIT CATALOG



Complete descriptions and
specifications of nearly 400
electronic kits

including:

stereo compo-
nents; auto,
marine and
aircraft acces-
sories; digital
clocks and
weather
instruments;
Amateur
Radio;
color TV;
personal
computers
and lots more!

